

# Service Manual

## TVR Pro CO Series



4TVY0077H8000AA

4TVY0192H8000AA

4TVY0096H8000AA

4TVY0210H8000AA

4TVY0115H8000AA

4TVY0229H8000AA

4TVY0140H8000AA

4TVY0249H8000AA

4TVY0155H8000AA

4TVY0268H8000AA

4TVY0170H8000AA

4TVY0290H8000AA

# CONTENTS

- Part 1 General Information..... 3**
- Part 2 Component Layout and Refrigerant Circuits ..... 12**
- Part 3 Control ..... 23**
- Part 4 Field Settings..... 33**
- Part 5 Electrical Components and Wiring Diagrams ..... 38**
- Part 6 Diagnosis and Troubleshooting..... 54**



# Part 1

## General Information

<b>1</b>	<b>Indoor and Outdoor Unit Capacities .....</b>	<b>4</b>
<b>2</b>	<b>External Appearance.....</b>	<b>6</b>
<b>3</b>	<b>Outdoor Unit Combinations.....</b>	<b>8</b>
<b>4</b>	<b>Combination Ratio.....</b>	<b>10</b>

# 1 Indoor and Outdoor Unit Capacities

## 1.1 Indoor Units

### 1.1.1 Standard indoor units

Table 1-1.1: Standard indoor unit abbreviation codes

Abbreviation code	Type
Q1	One-way Cassette
Q2	Two-way Cassette
Q4C	Compact Four-way Cassette
Q4	Four-way Cassette
T2	Medium Static Pressure Duct

Abbreviation code	Type
T1	High Static Pressure Duct
G	Wall-mounted
DL	Ceiling & Floor
F	Floor Standing

Table 1-1.2: Standard indoor unit capacity range

Capacity		Capacity index	Q1	Q2	Q4C	Q4	T2	T1	G	DL	F
kW	HP										
1.8	0.6	18	18	—	—	—	—	—	—	—	—
2.2	0.8	22	22	22	22	—	22	—	22	—	22
2.8	1	28	28	28	28	28	28	—	28	—	28
3.6	1.25	36	36	36	36	36	36	—	36	36	36
4.5	1.6	45	45	45	45	45	45	—	45	45	45
5.6	2	56	56	56	—	56	56	—	56	56	56
7.1	2.5	71	71	71	—	71	71	71	71	71	71
8.0	3	80	—	—	—	80	80	80	80	80	80
9.0	3.2	90	—	—	—	90	90	90	90	90	—
10.0	3.6	100	—	—	—	100	—	—	—	—	—
11.2	4	112	—	—	—	112	112	112	—	112	—
14.0	5	140	—	—	—	140	140	140	—	140	—
16.0	6	160	—	—	—	—	—	160	—	160	—
20.0	7	200	—	—	—	—	—	200	—	—	—
25.0	9	250	—	—	—	—	—	250	—	—	—
28.0	10	280	—	—	—	—	—	280	—	—	—
40.0	14	400	—	—	—	—	—	400	—	—	—
45.0	16	450	—	—	—	—	—	450	—	—	—
56.0	20	560	—	—	—	—	—	560	—	—	—

### 1.1.2 Fresh air processing unit

Table 1-1.3: Fresh air processing unit capacity range

Capacity	12.5kW	14kW	20kW	25kW	28kW	45kW	56kW
Capacity index	125	140	200	250	280	450	560

## 1.2 Heat recovery ventilator

Table 1-1.4: Heat recovery ventilator capacity range

Capacity	200m <sup>3</sup> /h	300m <sup>3</sup> /h	400m <sup>3</sup> /h	500m <sup>3</sup> /h	800m <sup>3</sup> /h	1000m <sup>3</sup> /h	1500m <sup>3</sup> /h	2000m <sup>3</sup> /h
----------	----------------------	----------------------	----------------------	----------------------	----------------------	-----------------------	-----------------------	-----------------------

### 1.3 Outdoor Units

Table 1-1.5: Outdoor unit capacity range

Capacity	Model Name	Combination Type
8HP	4TVY0077H8000AA	/
10HP	4TVY0096H8000AA	/
12HP	4TVY0115H8000AA	/
14HP	4TVY0140H8000AA	/
16HP	4TVY0155H8000AA	/
18HP	4TVY0170H8000AA	/
20HP	4TVY0192H8000AA	/
22HP	4TVY0210H8000AA	/
24HP	4TVY0229H8000AA	/
26HP	4TVY0249H8000AA	/
28HP	4TVY0268H8000AA	/
30HP	4TVY0290H8000AA	/
32HP	4TVY0310H8000AA	16HP+16HP
34HP	4TVY0325H8000AA	22HP+12HP
36HP	4TVY0347H8000AA	20HP+16HP
38HP	4TVY0365H8000AA	22HP+16HP
40HP	4TVY0384H8000AA	24HP+16HP
42HP	4TVY0404H8000AA	26HP+16HP
44HP	4TVY0423H8000AA	28HP+16HP
46HP	4TVY0445H8000AA	30HP+16HP
48HP	4TVY0459H8000AA	26HP+22HP
50HP	4TVY0478H8000AA	28HP+22HP
52HP	4TVY0500H8000AA	30HP+22HP
54HP	4TVY0517H8000AA	28HP+26HP
56HP	4TVY0536H8000AA	28HP+28HP
58HP	4TVY0558H8000AA	30HP+28HP
60HP	4TVY0580H8000AA	30HP+30HP
62HP	4TVY0600H8000AA	30HP+16HP+16HP
64HP	4TVY0614H8000AA	26HP+22HP+16HP
66HP	4TVY0633H8000AA	28HP+22HP+16HP
68HP	4TVY0655H8000AA	30HP+22HP+16HP
70HP	4TVY0672H8000AA	28HP+26HP+16HP
72HP	4TVY0691H8000AA	28HP+28HP+16HP
74HP	4TVY0713H8000AA	30HP+28HP+16HP
76HP	4TVY0735H8000AA	30HP+30HP+16HP
78HP	4TVY0746H8000AA	28HP+28HP+22HP
80HP	4TVY0768H8000AA	30HP+28HP+22HP
82HP	4TVY0790H8000AA	30HP+30HP+22HP
84HP	4TVY0804H8000AA	28HP+28HP+28HP
86HP	4TVY0826H8000AA	30HP+28HP+28HP
88HP	4TVY0848H8000AA	30HP+30HP+28HP
90HP	4TVY0870H8000AA	30HP+30HP+30HP

Notes:









1. The combinations of units shown in the table are factory-recommended. Other combinations of units are also possible.

## 2 External Appearance

### 2.1 Indoor Units

#### 2.1.1 Standard indoor unit

Table 1-2.1: Standard indoor unit appearance

<p>One-way Cassette Q1</p> 	<p>Two-way Cassette Q2</p> 
<p>Compact Four-way Cassette Q4C</p> 	<p>Four-way Cassette Q4</p> 
<p>Medium Static Pressure Duct T2</p> 	<p>High Static Pressure Duct T1</p> 
<p>Wall-mounted G</p> 	<p>Ceiling &amp; Floor DL</p> 
<p>Floor Standing F</p> 	

#### 2.1.2 Fresh air processing unit

Table 1-2.2: Fresh air processing unit appearance

<p>Fresh Air Processing Unit FA</p> 
-----------------------------------------------------------------------------------------------------------------------------

### 2.2 Heat Recovery Ventilator

Table 1-2.3: Heat recovery ventilator appearance

<p>Heat Recovery Ventilator</p> 
---------------------------------------------------------------------------------------------------------------------

## 2.3 Outdoor Units

### 2.3.1 Single units

Table 1-2.4: Single outdoor unit appearance

8/10/12/14/16HP (with single fan)	18/20/22HP (with dual fans)	24/26/28/30 (with dual fans)
		

### 2.3.2 Combinations of units

Table 1-2.5: Combination outdoor unit appearance









<p data-bbox="408 779 472 808"><b>32HP</b></p> 	<p data-bbox="1075 779 1235 808"><b>34/36/38/HP</b></p> 
<p data-bbox="344 1077 536 1106"><b>40/42/44/46HP</b></p> 	<p data-bbox="1078 1077 1238 1106"><b>48/50/52HP</b></p> 
<p data-bbox="344 1370 536 1400"><b>54/56/58/60HP</b></p> 	<p data-bbox="1123 1370 1187 1400"><b>62HP</b></p> 
<p data-bbox="360 1704 520 1733"><b>64/66/68HP</b></p> 	<p data-bbox="1059 1704 1251 1733"><b>70/72/74/76HP</b></p> 



Table 1-2.5: Combination outdoor unit appearance



### 3 Outdoor Unit Combinations

Table 1-3.1: Outdoor unit combinations

System capacity		Number of units	Modules <sup>1</sup>												Outdoor branch joint kit <sup>2</sup>
kW	HP		8	10	12	14	16	18	20	22	24	26	28	30	
22.4	8	1	•												—
28.0	10	1		•											
33.5	12	1			•										
40.0	14	1				•									
45.0	16	1					•								
50.0	18	1						•							
56.0	20	1							•						
61.5	22	1								•					
67.0	24	1									•				
73.0	26	1										•			
78.5	28	1											•		
85.0	30	1												•	
90.0	32	2						••							TODK02UTHP
95.0	34	2			•					•					
101.0	36	2						•							
106.5	38	2						•		•					
112.0	40	2						•			•				
118.0	42	2						•				•			
123.5	44	2						•					•		
130.0	46	2						•						•	
134.5	48	2								•		•			
140.0	50	2								•			•		
146.5	52	2								•				•	
151.5	54	2									•		•		
157.0	56	2										••			
163.5	58	2											•	•	
170.0	60	2												••	
175.0	62	3						••						•	TODK03UTHP
179.5	64	3						•		•		•			
185.0	66	3						•		•			•		
191.5	68	3						•		•				•	
196.5	70	3						•			•		•		
202.0	72	3						•				••			
208.5	74	3						•					•	•	
215.0	76	3						•						••	
218.5	78	3								•			••		
225.0	80	3								•			•	•	
231.5	82	3								•				••	

235.5	84	3											•••	
-------	----	---	--	--	--	--	--	--	--	--	--	--	-----	--

Table continued on next page...

Table 1-3.1: Outdoor unit combinations

System capacity		Number of units	Modules <sup>1</sup>										Outdoor branch joint kit <sup>2</sup>		
242.0	86	3											••	•	TODK03UTHP
248.5	88	3											•	••	
255.0	90	3												•••	

Notes:

1. The combinations of units shown in the table are factory-recommended. Other combinations of units are also possible.
2. For systems with two or more outdoor units, outdoor branch joints (sold separately) are required.

## 4 Combination Ratio

$$\text{Combination ratio} = \frac{\text{Sum of capacity indexes of the indoor units}}{\text{Capacity index of the outdoor units}}$$

Table 1-5.1: Indoor and outdoor unit combination ratio limitations

Type	Minimum combination ratio	Maximum combination ratio		
		Standard indoor units only	Fresh air processing units only	Fresh air processing units and standard indoor units together
TVR Pro CO series ODU	50%	130% <sup>1</sup>	100%	100% <sup>2</sup>

Notes:

1. The total capacity of the indoor units can be up to a maximum of 130% of the combined capacity of the outdoor unit for a system where not all the indoor units are operating at the same time.
2. When fresh air processing units are installed together with standard indoor units, the total capacity of the fresh air processing units must not exceed 30% of the total capacity of the outdoor units and the combination ratio must not exceed 100%.

Table 1-5.2: Combinations of Indoor and outdoor units

Outdoor unit capacity			Sum of capacity indexes of connected indoor units (standard indoor units only)	Sum of capacity indexes of connected indoor units (fresh air processing units and standard indoor units together)	Maximum number of connected indoor units
kW	HP	Capacity index			
22.4	8	224	112 to 291.2	112 to 224	13
28	10	280	140 to 364	140 to 280	16
33.5	12	335	167.5 to 435.5	167.5 to 335	20
40	14	400	200 to 520	200 to 400	23
45	16	450	225 to 585	225 to 450	26
50	18	500	250 to 650	250 to 500	29
56	20	560	280 to 728	280 to 560	33
61.5	22	615	307.5 to 799.5	307.5 to 615	36
67	24	670	335 to 871	335 to 670	39
73	26	730	365 to 949	365 to 730	43
78.5	28	785	392.5 to 1020.5	392.5 to 785	46
85	30	850	425 to 1105	425 to 850	50
90	32	900	450 to 1170	450 to 900	53
95	34	950	475 to 1235	475 to 950	56
101	36	1010	505 to 1313	505 to 1010	59
106.5	38	1065	532.5 to 1384.5	532.5 to 1065	63
112	40	1120	560 to 1456	560 to 1120	64
118	42	1180	590 to 1534	590 to 1180	
123.5	44	1235	617.5 to 1605.5	617.5 to 1235	
130	46	1300	650 to 1690	650 to 1300	
134.5	48	1345	672.5 to 1748.5	672.5 to 1345	
140	50	1400	700 to 1820	700 to 1400	
146.5	52	1465	732.5 to 1904.5	732.5 to 1465	
151.5	54	1515	757.5 to 1969.5	757.5 to 1515	
157	56	1570	785 to 2041	785 to 1570	
163.5	58	1635	817.5 to 2125.5	817.5 to 1635	
170	60	1700	850 to 2210	850 to 1700	
175	62	1750	875 to 2275	875 to 1750	
179.5	64	1795	897.5 to 2333.5	897.5 to 1795	
185	66	1850	925 to 2405	925 to 1850	
191.5	68	1915	957.5 to 2489.5	957.5 to 1915	
196.5	70	1965	982.5 to 2554.5	982.5 to 1965	
202	72	2020	1010 to 2626	1010 to 2020	
208.5	74	2085	1042.5 to 2710.5	1042.5 to 2085	

215	76	2150	1075 to 2795	1075 to 2150
218.5	78	2185	1092.5 to 2840.5	1092.5 to 2185
225	80	2250	1125 to 2925	1125 to 2250
231.5	82	2315	1157.5 to 3009.5	1157.5 to 2315
235.5	84	2355	1177.5 to 3061.5	1177.5 to 2355
242	86	2420	1210 to 3146	1210 to 2420
248.5	88	2485	1242.5 to 3230.5	1242.5 to 2485
255	90	2550	1275 to 3315	1275 to 2550

# Part 2

# Component Layout and Refrigerant Circuits

1	Layout of Functional Components .....	13
2	Piping Diagrams .....	16
3	Refrigerant Flow Diagrams .....	20

# 1 Layout of Functional Components

## 8-16HP

Figure 2-1.1: 8-16HP layout of functional components

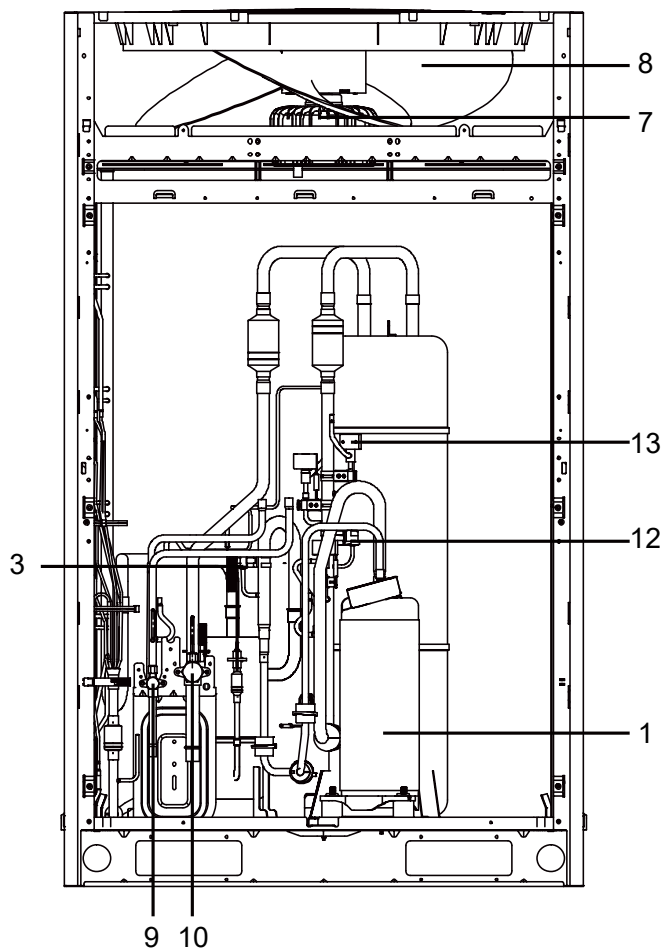
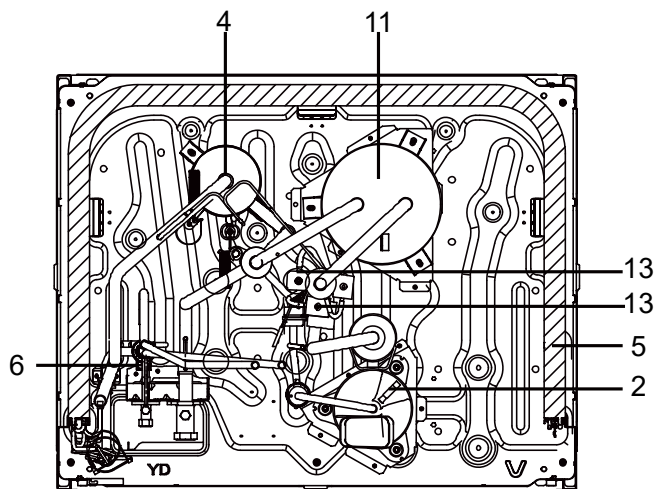

Legend	
No.	Parts name
1	Compressor
2	Discharge temperature sensor
3	High pressure sensor
4	Oil separator
5	Heat exchanger
6	Electronic expansion valve (EXV)
7	Fan motor
8	Fan
9	Stop valve (liquid side)
10	Stop valve (gas side)
11	Accumulator
12	Low pressure switch
13	Solenoid valve

# 18-22HP

Figure 2-1.2: 18-22HP layout of functional components

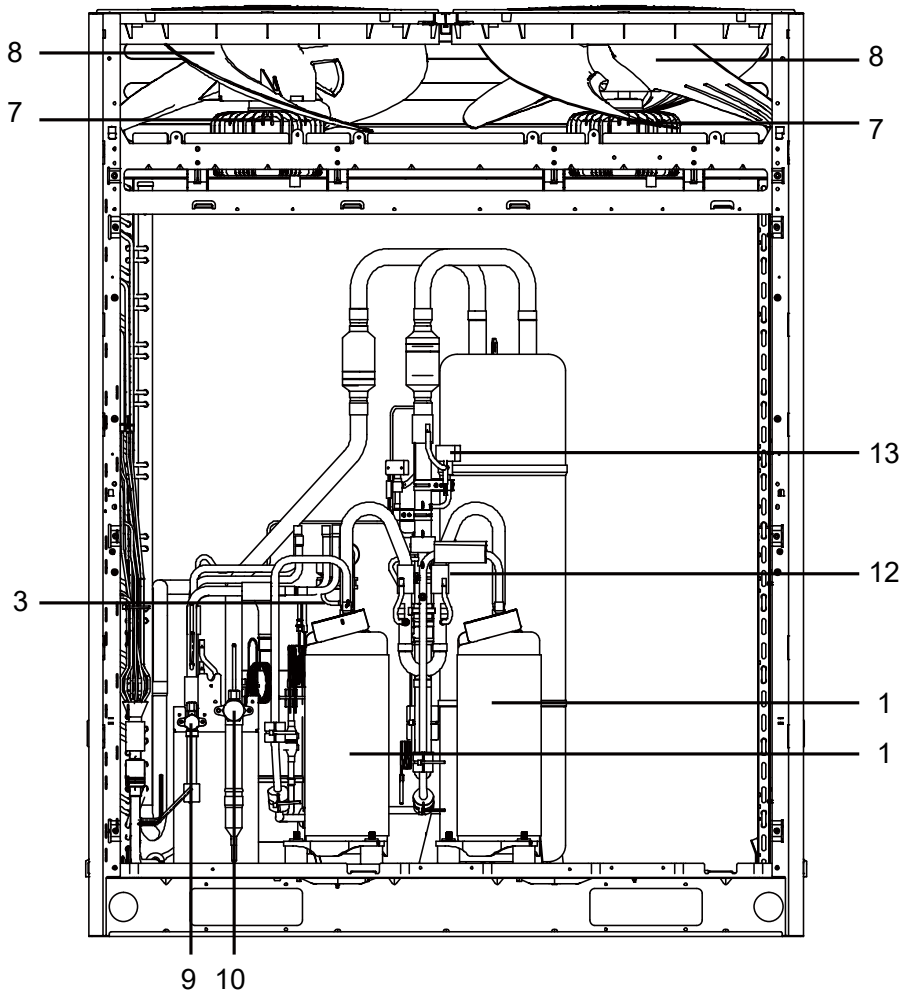
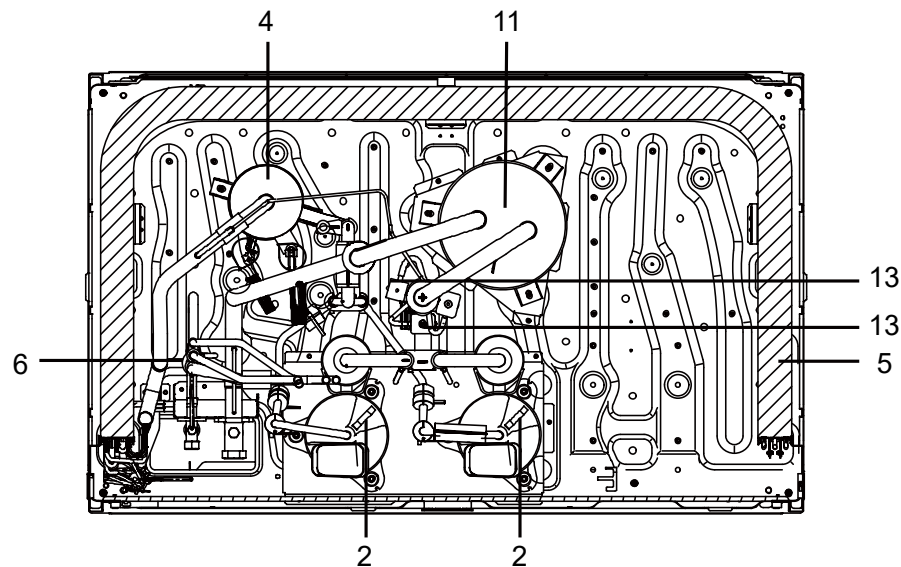

Legend	
No.	Parts name
1	Compressor
2	Discharge temperature sensor
3	High pressure sensor
4	Oil separator
5	Heat exchanger
6	Electronic expansion valve (EXV)
7	Fan motor
8	Fan
9	Stop valve (liquid side)
10	Stop valve (gas side)
11	Accumulator
12	Low pressure switch
13	Solenoid valve

## 24-30HP

Figure 2-1.3: 24-30HP layout of functional components

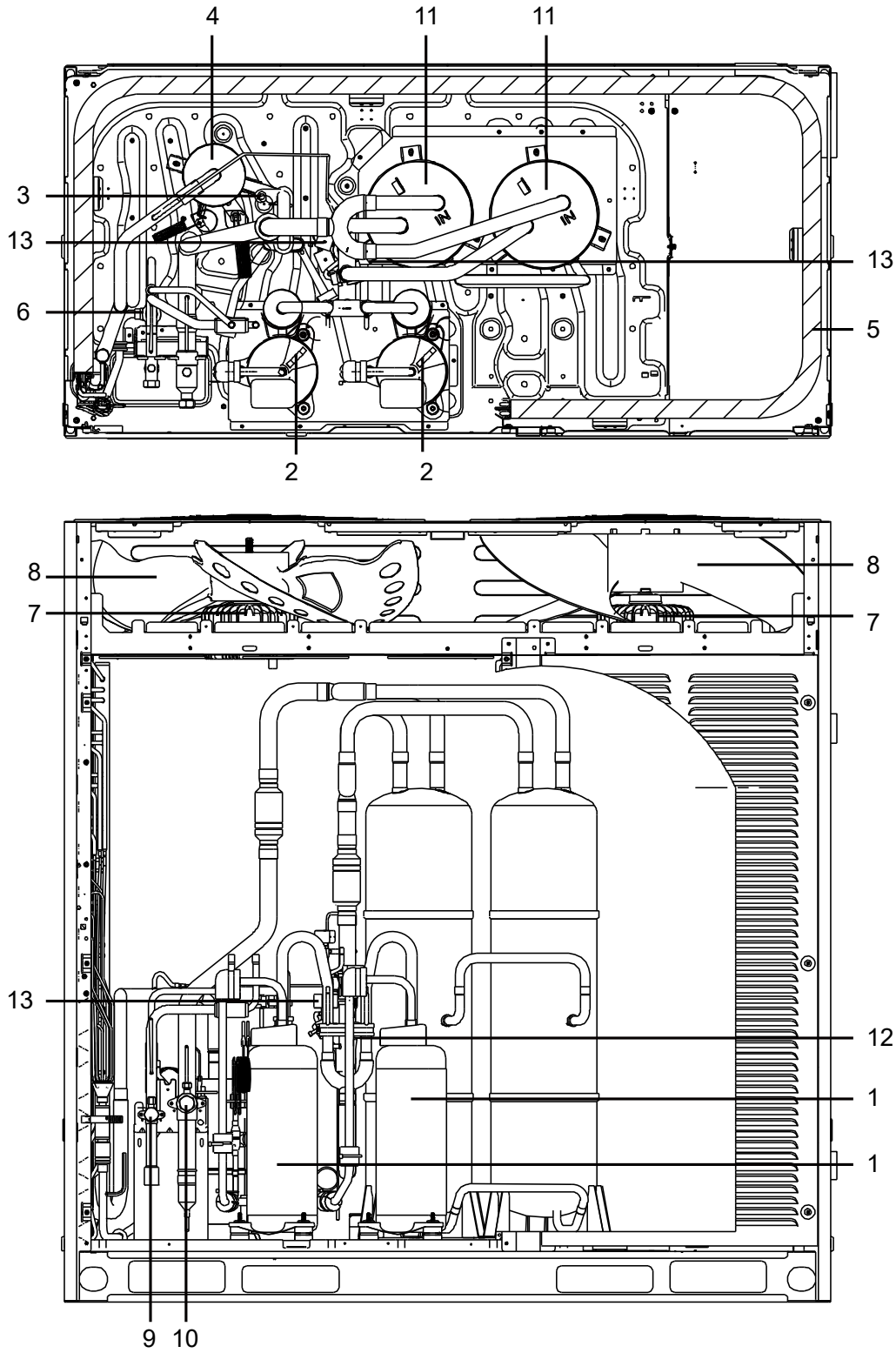

Legend	
No.	Parts name
1	Compressor
2	Discharge temperature sensor
3	High pressure sensor
4	Oil separator
5	Heat exchanger
6	Electronic expansion valve (EXV)
7	Fan motor
8	Fan
9	Stop valve (liquid side)
10	Stop valve (gas side)
11	Accumulator
12	Low pressure switch
13	Solenoid valve



## 2 Piping Diagrams

### 8-16HP

Figure 2-2.1: 8-16HP piping diagram

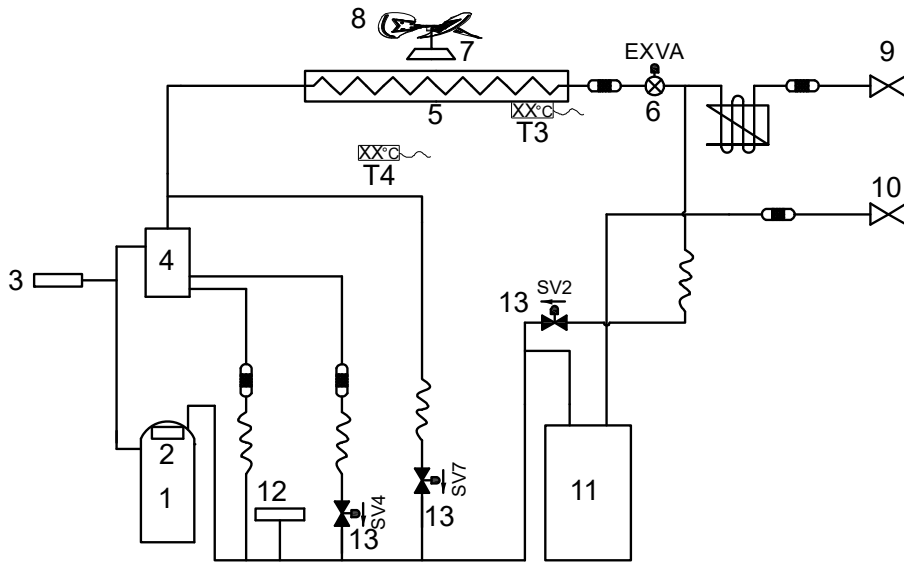

Legend			
No.	Parts name	No.	Parts name
1	Compressor	10	Stop valve (gas side)
2	Discharge temperature sensor	11	Accumulator
3	High pressure sensor	12	Low pressure switch
4	Oil separator	13	Solenoid valve
5	Heat exchanger	T3	Heat exchanger temperature sensor
6	Electronic expansion valve (EXV)	T4	Outdoor ambient temperature sensor
7	Fan motor	SV2	Liquid injection valve
8	Fan	SV4	Oil return valve
9	Stop valve (liquid side)	SV7	Pressure valve

18-22HP

Figure 2-2.2: 18-22HP piping diagram

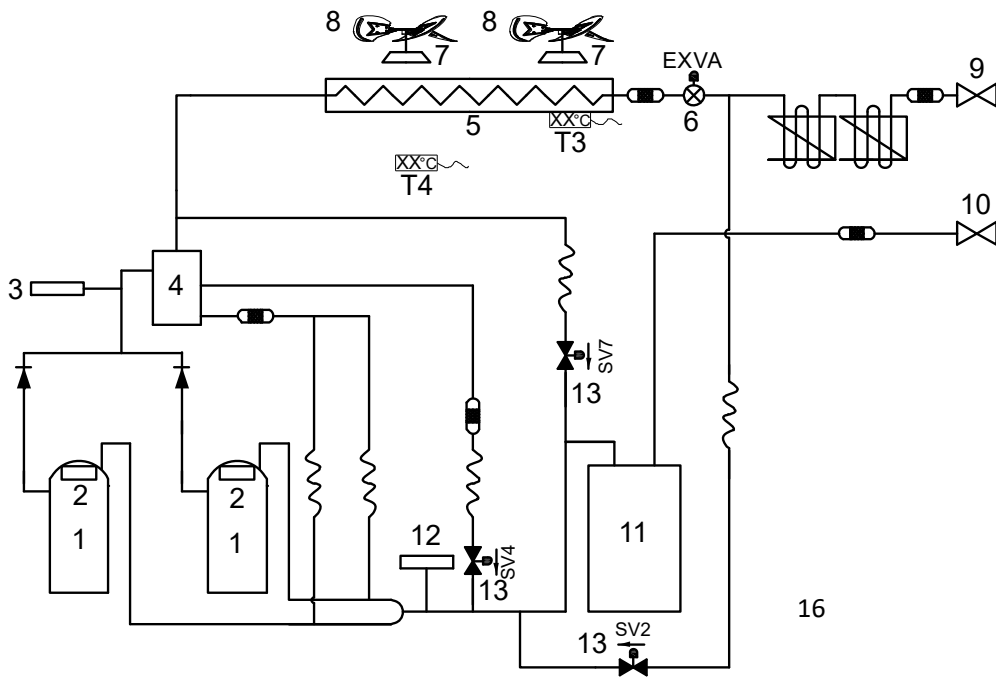

Legend			
No.	Parts name	No.	Parts name
1	Compressor	10	Stop valve (gas side)
2	Discharge temperature sensor	11	Accumulator
3	High pressure sensor	12	Low pressure switch
4	Oil separator	13	Solenoid valve
5	Heat exchanger	T3	Heat exchanger temperature sensor
6	Electronic expansion valve (EXV)	T4	Outdoor ambient temperature sensor
7	Fan motor	SV2	Liquid injection valve
8	Fan	SV4	Oil return valve
9	Stop valve (liquid side)	SV7	Pressure valve

24-30HP

Figure 2-2.3: 24-30HP piping diagram

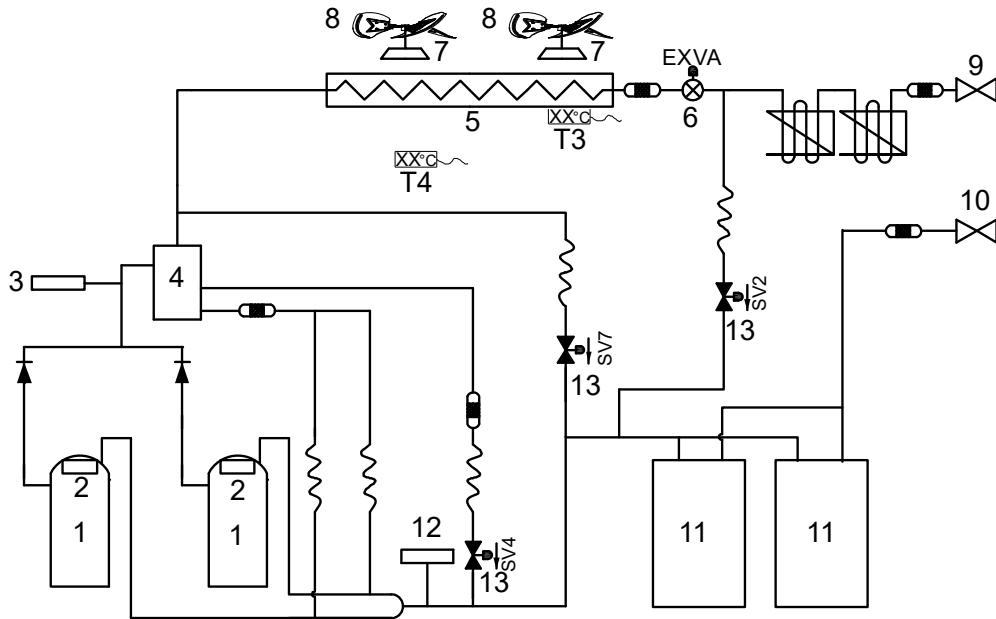

Legend			
No.	Parts name	No.	Parts name
1	Compressor	10	Stop valve (gas side)
2	Discharge temperature sensor	11	Accumulator
3	High pressure sensor	12	Low pressure switch
4	Oil separator	13	Solenoid valve
5	Heat exchanger	T3	Heat exchanger temperature sensor
6	Electronic expansion valve (EXV)	T4	Outdoor ambient temperature sensor
7	Fan motor	SV2	Liquid injection valve
8	Fan	SV4	Oil return valve
9	Stop valve (liquid side)	SV7	Pressure valve

**Key components:**

1. **Oil separator:**  
Separates oil from gas refrigerant pumped out of the compressor and quickly returns it to the compressor. Separation efficiency is up to 99%.
2. **Accumulator:**  
Stores liquid refrigerant and oil to protect compressor from liquid hammering.
3. **Electronic expansion valve (EXV):**  
Controls refrigerant flow and reduces refrigerant pressure.
4. **Solenoid valve SV2:**  
Protects the compressor. If compressor discharge temperature rises above 100°C, SV2 opens and sprays a small amount of liquid refrigerant to cool the compressor. SV2 closes again once the discharge temperature has fallen below 90°C.
5. **Solenoid valve SV4:**  
Returns oil to the compressor. Opens once the compressor has run for 200 seconds and closes 600 seconds later and then opens for 3 minutes every 20 minutes.
6. **Solenoid valve SV7:**  
Allows refrigerant to return directly to the compressor. Opens when indoor air temperature is close to the set temperature to avoid frequent compressor on/off. Opens when superheat degree is insufficient to avoid liquid hammer to compressor.
7. **Low pressure switches:**  
Regulate system pressure. When system pressure falls below the lower limit, the low pressure switches turn off, stopping the compressor. After 10 minutes, the compressor restarts.

### 3 Refrigerant Flow Diagrams

#### 8-16HP

#### Cooling operation

Figure 2-3.1: 8-16HP refrigerant flow during cooling operation

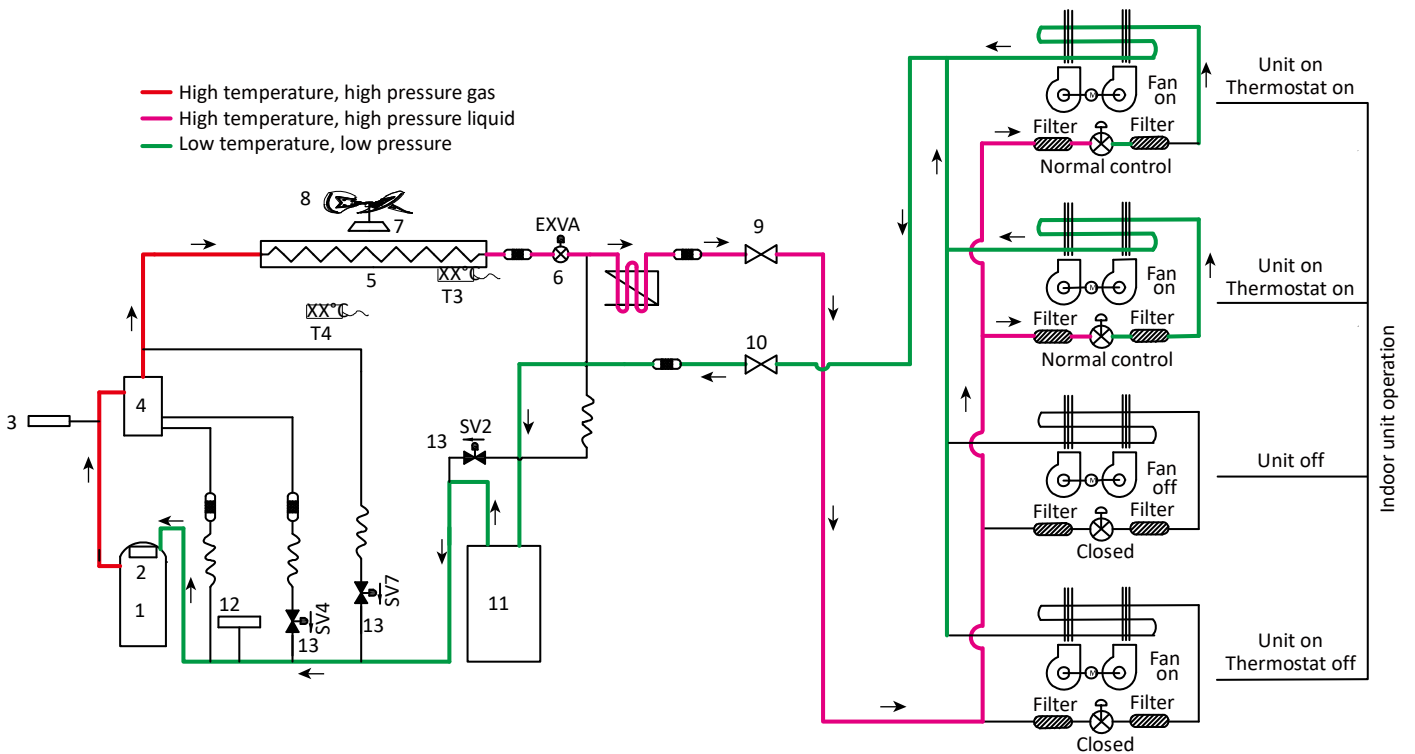

#### Oil return operation in cooling mode

Figure 2-3.2: 8-16HP refrigerant flow during oil return operation in cooling mode

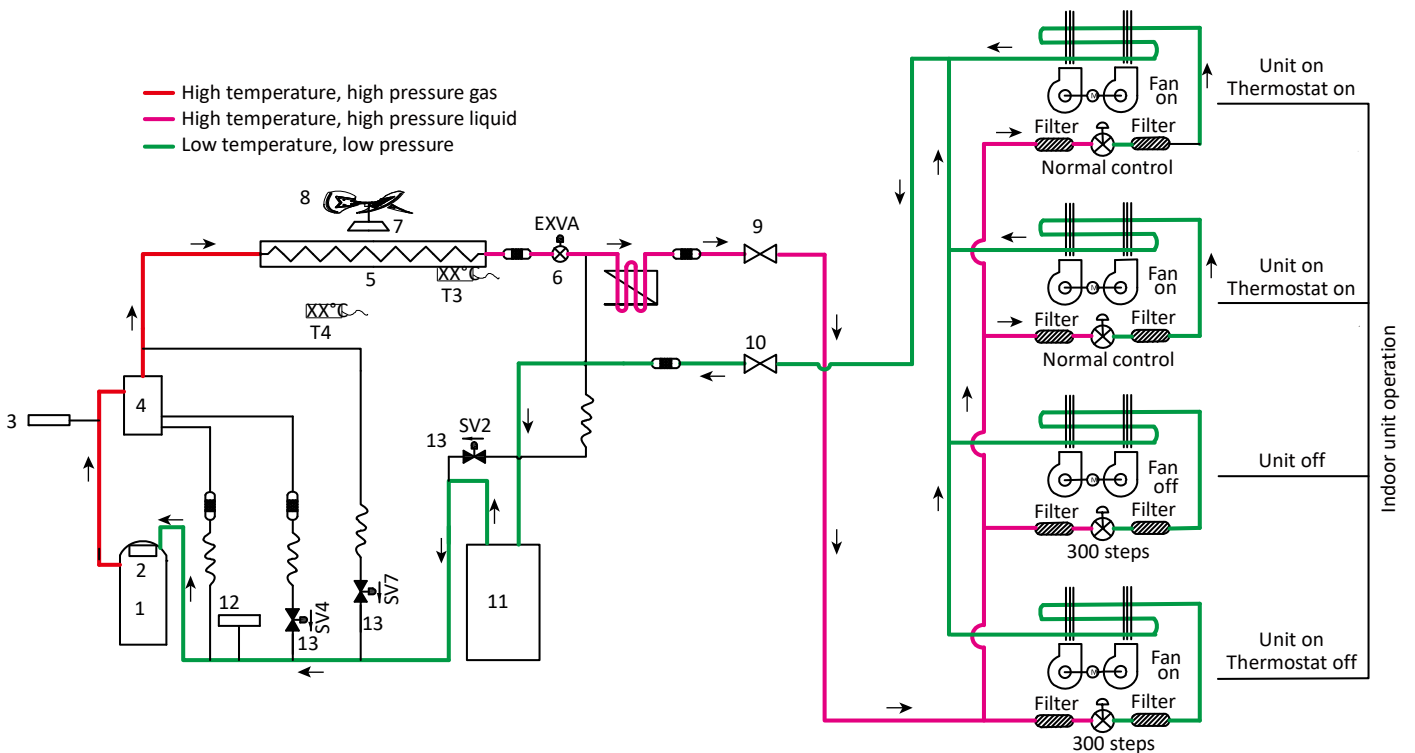

# 18-22HP

## Cooling operation

Figure 2-3.3: 18-22HP refrigerant flow during cooling operation

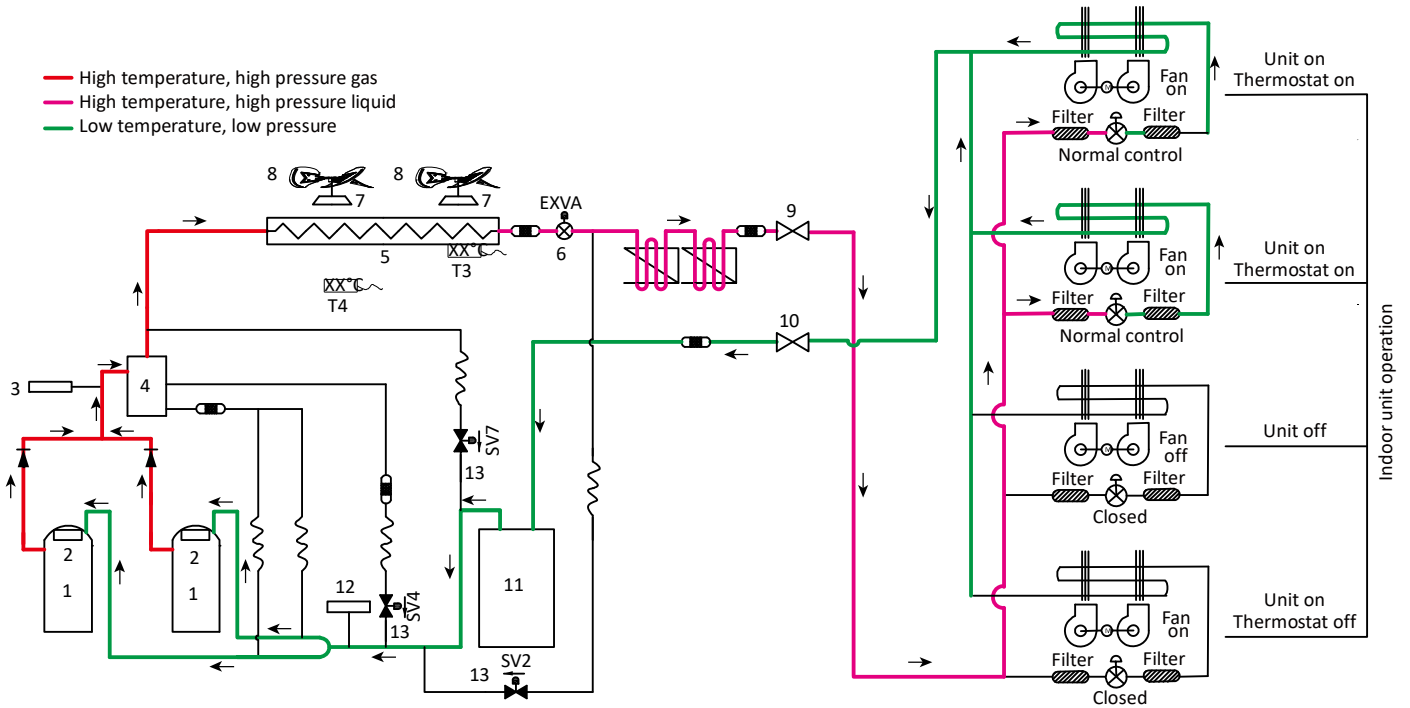

## Oil return operation in cooling mode

Figure 2-3.4: 18-22HP refrigerant flow during oil return operation in cooling mode

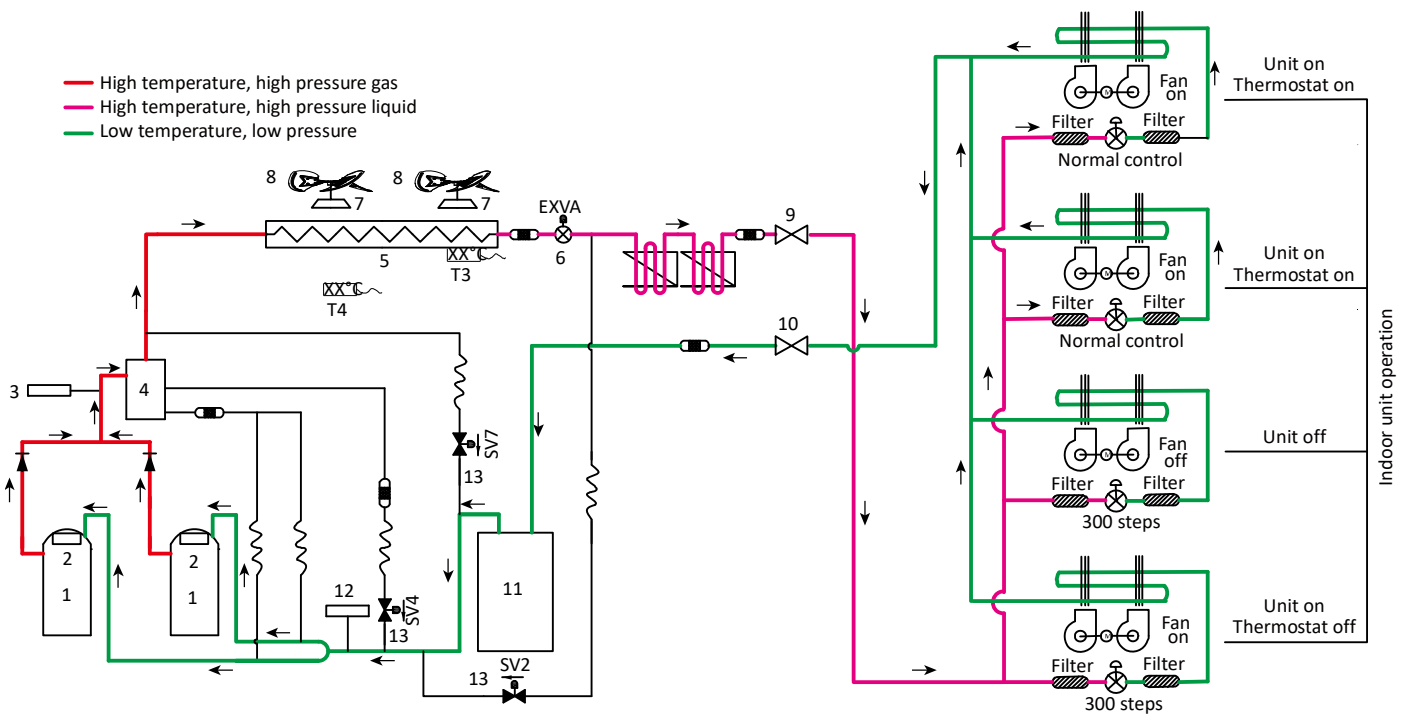

# 24-30HP

## Cooling operation

Figure 2-3.5: 24-30HP refrigerant flow during cooling operation

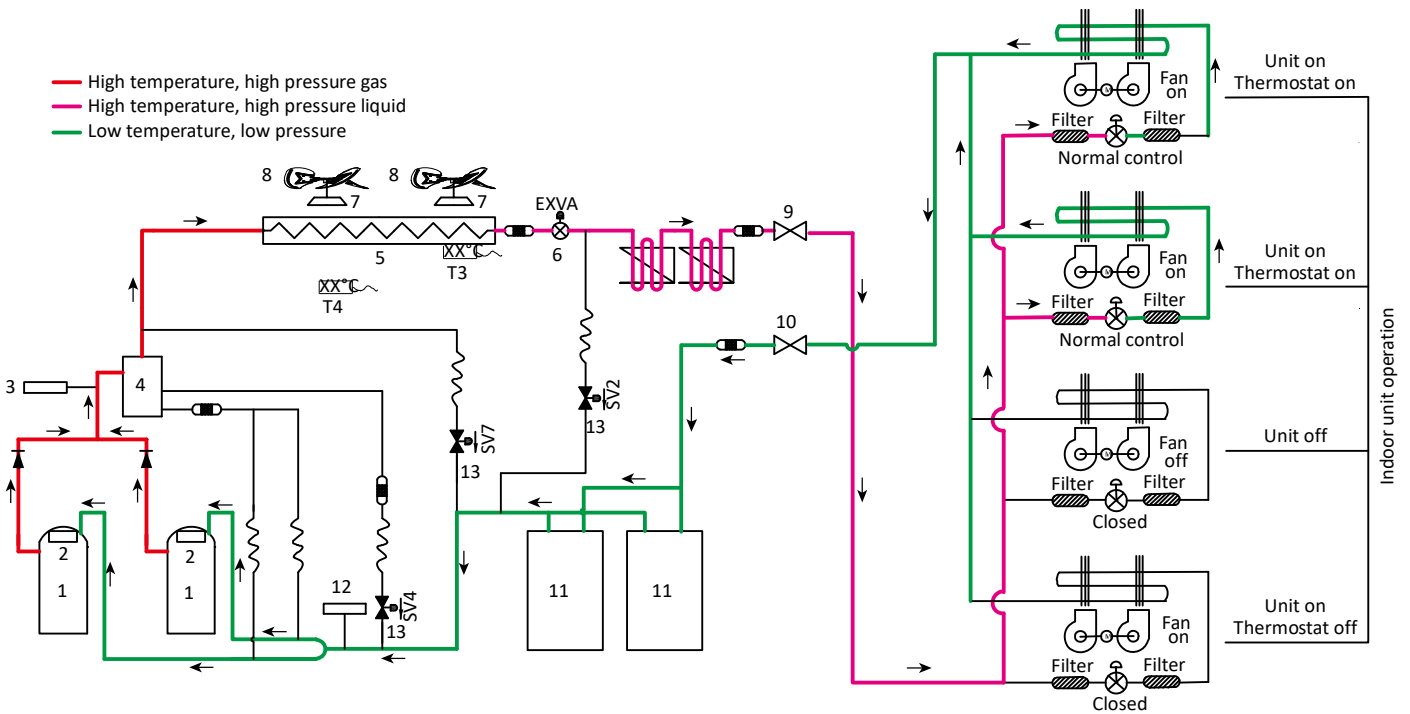

## Oil return operation in cooling mode

Figure 2-3.6: 24-30HP refrigerant flow during oil return operation in cooling mode

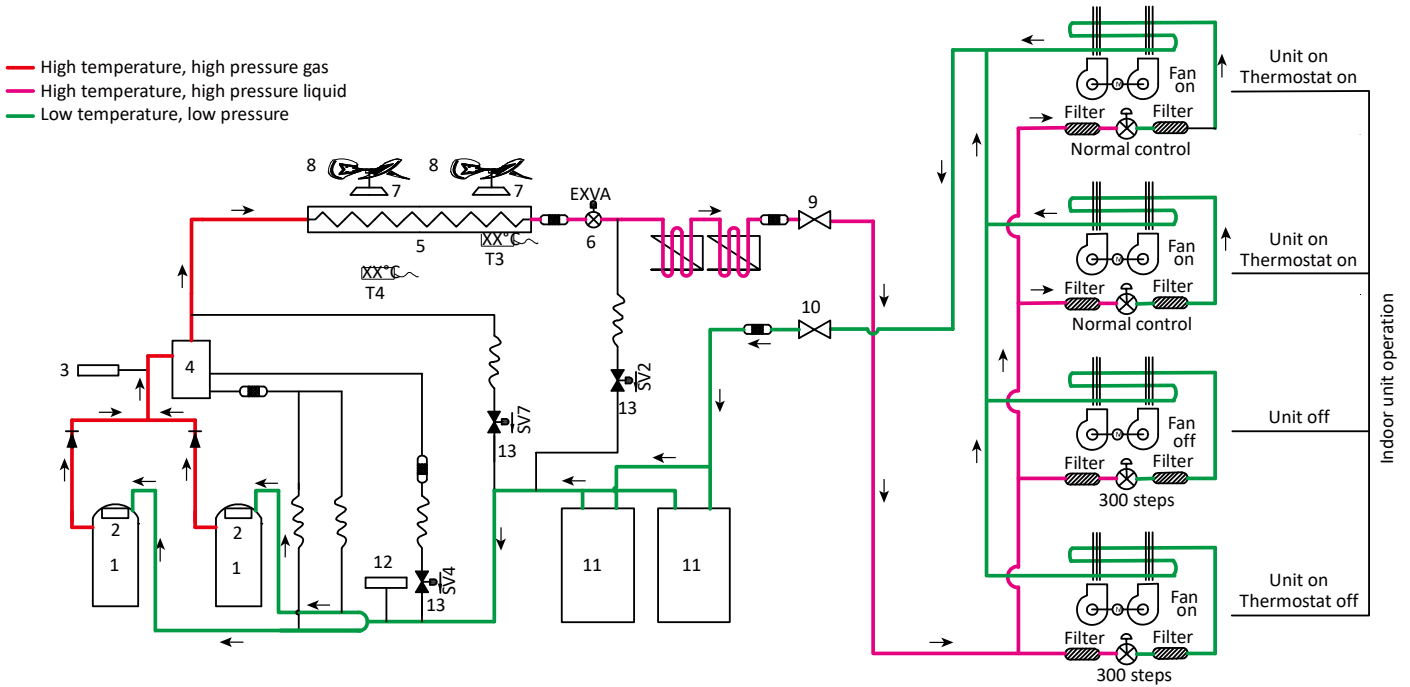

# Part 3

# Control

<b>1 General Control Scheme Flowchart .....</b>	<b>24</b>
<b>2 Stop Operation.....</b>	<b>25</b>
<b>3 Startup Control .....</b>	<b>25</b>
<b>4 Normal Operation Control.....</b>	<b>26</b>
<b>5 Protection Control.....</b>	<b>29</b>
<b>6 Special Control .....</b>	<b>31</b>



# 1 General Control Scheme Flowchart

Sections 3-2 to 3-6 on the following pages detail when each of the controls in the flowchart below is activated.

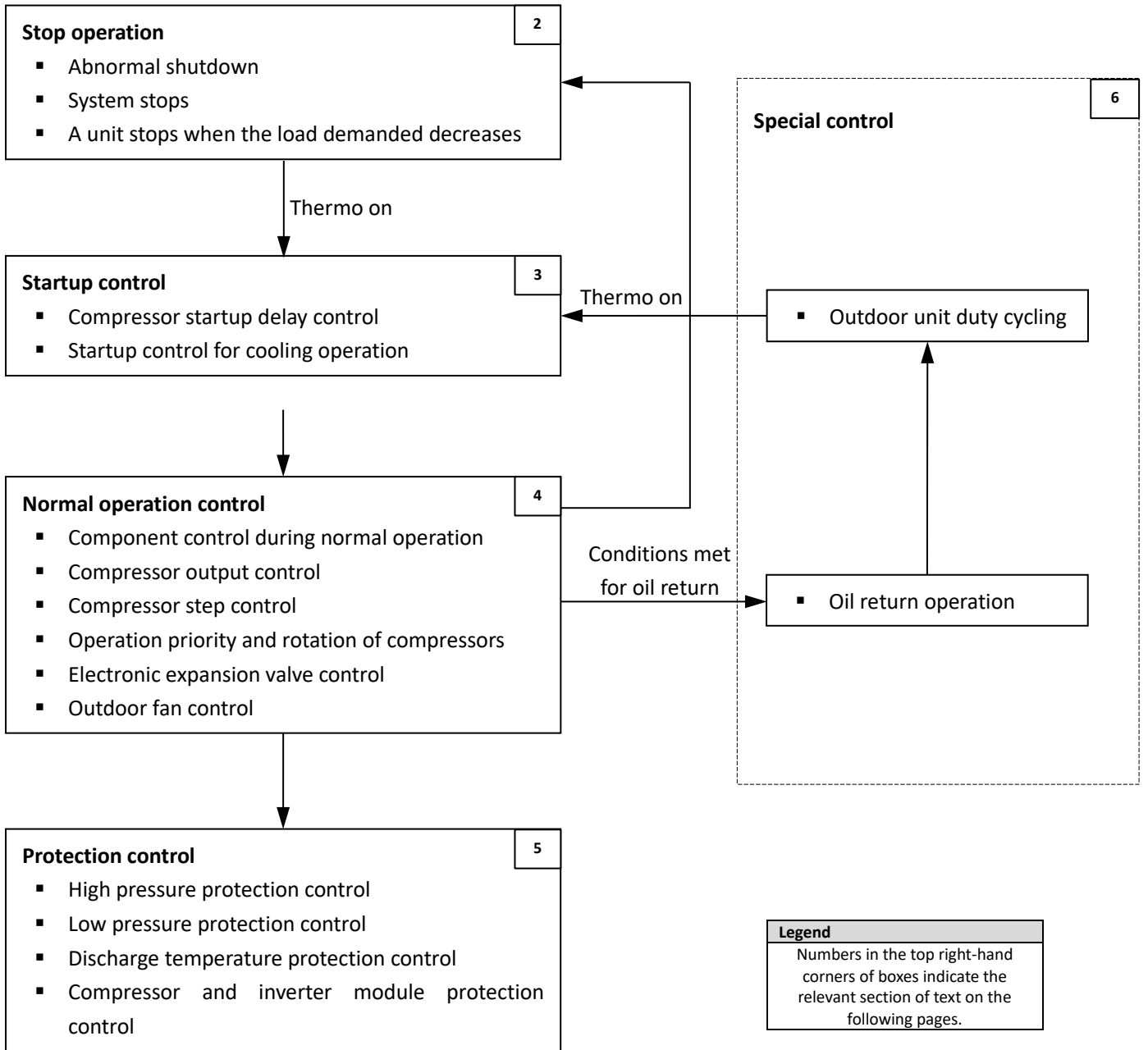

## 2 Stop Operation

The stop operation occurs for one of the three following reasons:

1. Abnormal shutdown: in order to protect the compressors, if an abnormal state occurs the system makes a 'stop with thermo off' operation and an error code is displayed on the outdoor unit digital displays.
2. The system stops when the set temperature has been reached.
3. A unit stops when the load demanded by the indoor units decreases and can be handled by fewer outdoor units.

## 3 Startup Control

### 3.1 Compressor Startup Delay Control

In initial startup control, compressor startup is delayed for 12 minutes in order to let the master unit search for the indoor units' addresses. In restart control (except in oil return operation), compressor startup is delayed such that a minimum of 7 minutes has elapsed since the compressor stopped, in order to prevent frequent compressor on/off and to equalize the pressure within the refrigerant system.

### 3.2 Startup Control for Cooling Operation

Table 3-3.1: Component control during startup in cooling mode

Component	Wiring diagram label	8-12HP	14-16HP	18-22HP	24-30HP	Control functions and states
Inverter compressor A	BP1	●	●	●	●	Controlled according to load requirement, operating frequency increased by 1 step / sec
Inverter compressor B	BP2			●	●	
DC fan motor A	FAN1	●	●	●	●	Fan speed controlled according to discharge pressure ( $P_c$ ): <ul style="list-style-type: none"> <li>▪ At initial speed for 90 seconds.</li> <li>▪ Subsequently, <math>P_c</math> checked every 10 seconds: <ul style="list-style-type: none"> <li>• <math>P_c \geq 2.7\text{MPa} \Rightarrow</math> 1 step increase.</li> <li>• <math>P_c \leq 2.1\text{MPa} \Rightarrow</math> 1 step decrease.</li> </ul> </li> </ul>
DC fan motor B	FAN2			●	●	
Electronic expansion valve A	EXVA	●	●	●	●	Position (steps) from 0 (fully closed) to 3000 (fully open), controlled according to discharge temperature
Solenoid valve (Liquid injection)	SV2	●	●	●	●	Controlled according to discharge temperature
Solenoid valve (oil balance)	SV4	●	●	●	●	Closed for 200 secs, open for 600 secs, then closed
Solenoid valve (refrigerant bypass)	SV7	●	●	●	●	Controlled according to load requirement and discharge pressure

## 4 Normal Operation Control

### 4.1 Component Control during Normal Operation

Table 3-4.1: Component control during normal cooling operation

Component	Wiring diagram label	8-12HP	14-16HP	18-22HP	24-30HP	Control functions and states
Inverter compressor A	BP1	•	•	•	•	Controlled according to load requirement
Inverter compressor B	BP2			•	•	
DC fan motor A	FAN1	•	•	•	•	Controlled according to discharge pressure
DC fan motor B	FAN2			•	•	
Electronic expansion valve A	EXVA	•	•	•	•	Position (steps) from 0 (fully closed) to 3000 (fully open), controlled according to discharge temperature
Solenoid valve (Liquid injection)	SV2	•	•	•	•	Controlled according to discharge temperature
Solenoid valve (oil balance)	SV4	•	•	•	•	Open regularly
Solenoid valve (refrigerant bypass)	SV7	•	•	•	•	Controlled according to ambient temperature, discharge pressure, compressor running frequency, discharge superheating degree, load requirement, discharge temperature and discharge pressure.

### 4.2 Compressor Output Control

The compressor rotation speed is controlled according to the load requirement. Before compressor startup, the outdoor units first estimate the indoor unit load requirement according to the nominal capacity of indoor units currently running, and then correct for ambient temperature. The compressors then start up according to the corrected load requirement.

During operation the compressors are controlled according to the nominal capacity of indoor units currently running and the indoor unit heat exchanger temperatures. If the actual load requirement can be provided by one unit alone, then only one unit starts up. If the actual load requirement requires all outdoor unit modules to operate, the weighted average actual load requirement is sent to each module and each module operates according to this distributed load requirement.

### 4.3 Compressor Step Control

The compressor speed can be altered in increments of 1 rps (rotations per second) and decrease of 2rps.

### 4.4 Operating Priority and Rotation of Compressors

Figures 3-4.1 to 3-4.3 show the compressor operating priority and rotation in systems with one, two and three outdoor units. In units with two compressors, inverter compressor A (BP1) operates in priority to inverter compressor B (BP2). In multi-unit systems, units operate in rotation. In Figures 3-4.2 and 3-4.3 the master unit and slave units 1 and 2 are shown from left to right in that order, and the circled numbers (①, ②, ③) indicate the rotation sequence.

Figure 3-4.1: Compressor priority and rotation – one outdoor unit



Figure 3-4.2: Compressor priority and rotation – two outdoor units

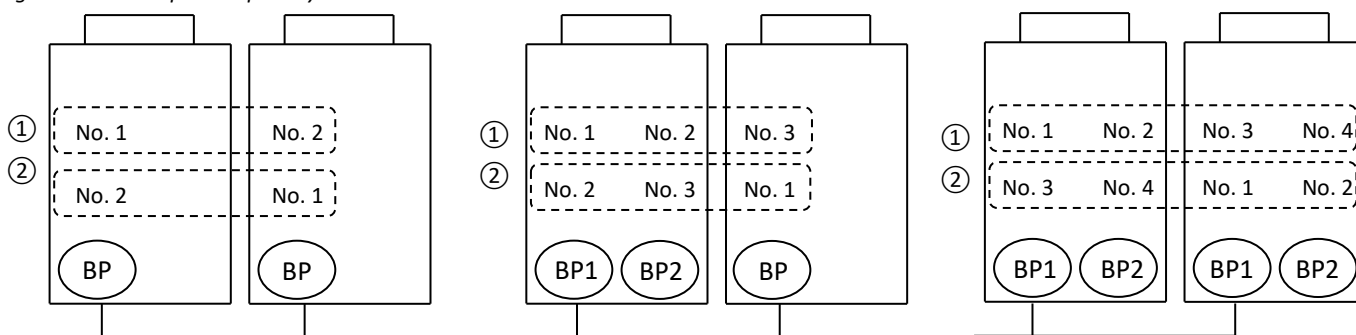
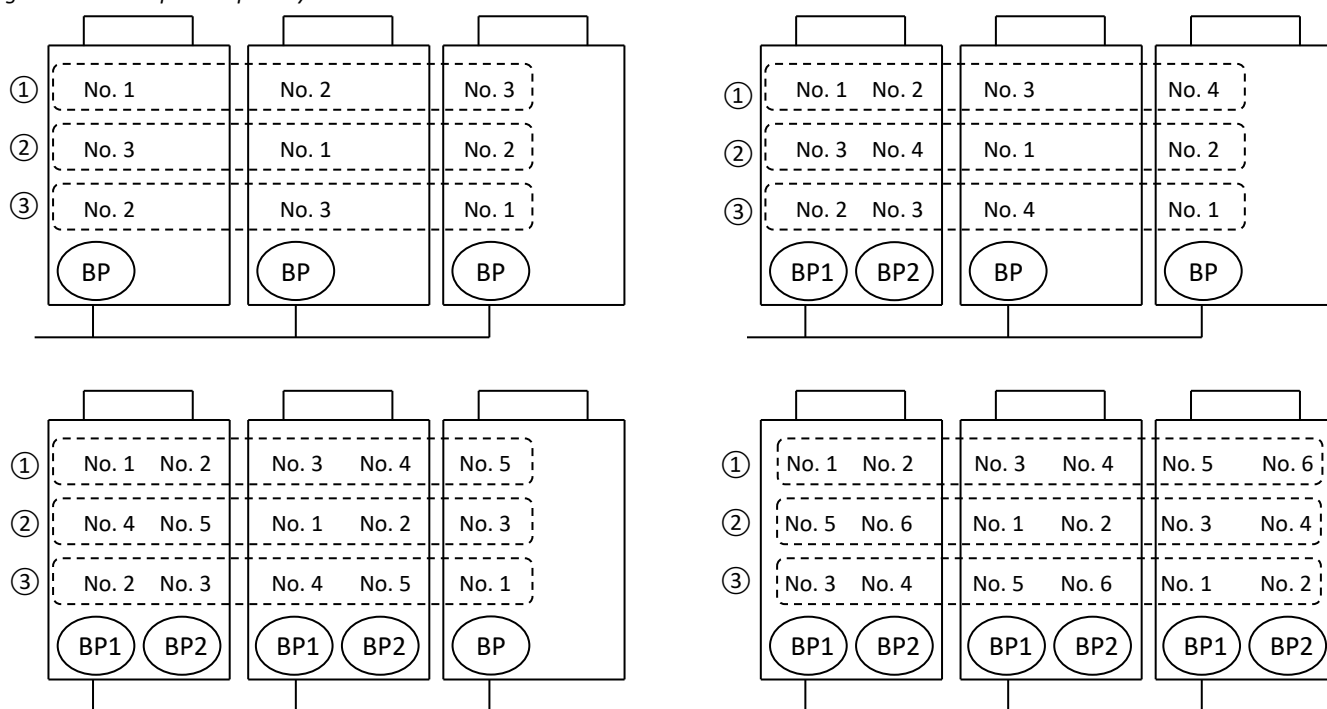

Figure 3-4.3: Compressor priority and rotation – three outdoor units



## 4.5 Electronic Expansion Valve Control

### EXVA control

The position of electronic expansion valve EXVA is controlled in steps from 0 (fully closed) to 3000 (fully open).

In cooling mode:

- When all outdoor units are in standby:
  - All EXVAs are at position  $352 \times 6$ (steps).
- When some outdoor units are running and some outdoor units are in standby:
  - EXVAs on running outdoor units are controlled according to discharge temperature. EXVAs of units in standby are

fully closed.

- When all outdoor units are running:
  - All EXVAs are controlled according to discharge temperature.

## 4.6 Outdoor Fan Control

The speed of the outdoor unit fans is adjusted in steps, as shown in Table 3-4.2.

Table 3-4.2: Outdoor fan speed steps

Fan speed index	Fan speed (rpm)		
	8-16HP	18-22HP	24-30HP
		FANA / FANB	FANA / FANB
0	0	0 / 0	0 / 0
1	120	150 / 0	120 / 0
2	150	190 / 0	150 / 0
3	170	230 / 0	170 / 0
4	190	270 / 0	190 / 0
5	210	310 / 0 (150 / 150)	210 / 0
6	230	350 / 0 (180 / 180)	230 / 0
7	250	380 / 0 (210 / 210)	250 / 0 (120 / 120)
8	270	410 / 0 (240 / 240)	270 / 0 (150 / 150)
9	290	280 / 280	330 / 0 (170 / 170)
10	310	320 / 320	370 / 0 (190 / 190)
11	330	360 / 360	210 / 210
12	350	400 / 400	230 / 230
13	370	440 / 440	250 / 250
14	390	480 / 480	270 / 270
15	410	520 / 520	290 / 290
16	430	560 / 560	310 / 310
17	450	600 / 600	330 / 330
18	470	640 / 640	350 / 350
19	490	680 / 680	370 / 370
20	510	720 / 720	400 / 400
21	530	750 / 750	430 / 430
22	560	780 / 780	470 / 470
23	580	800 / 800	510 / 510
24	600	840 / 840	550 / 550
25	630	880 / 880	600 / 600
26	650	910 / 880	650 / 650
27	700	910 / 910	680 / 680
28	750	940 / 910	700 / 700
29	800	940 / 940	750 / 750
30	850	980 / 940	780 / 780
31	880	980 / 980	800 / 800
32	910	1000 / 980	830 / 830
33	930	1000 / 1000	850 / 850
34	960	1020 / 1000	870 / 870
35	1000	1020 / 1020	890 / 890
36	1050	1050 / 1050	920 / 920
37	1100	1100 / 1100	950 / 950

Note:

1. For 18-22HP unit fan speed 5 to 8 and 24-30HP unit fan speed 7 to 10, when fan speed decreases, the fan speed is shown in the bracket; when fan speed increases, the fan speed is shown without bracket.

## 5 Protection Control

### 5.1 High Pressure Protection Control

This control protects the system from abnormally high pressure and protects the compressors from transient spikes in pressure.

Figure 3-5.1: High pressure protection control

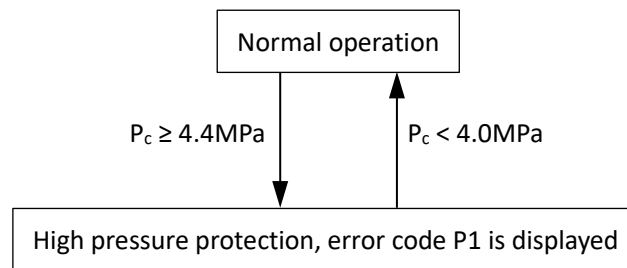

Notes:

1. P<sub>c</sub>: Discharge pressure

### 5.2 Low Pressure Protection Control

This control protects the system from abnormally low pressure and protects the compressors from transient drops in pressure.

Figure 3-5.2: Low pressure protection control

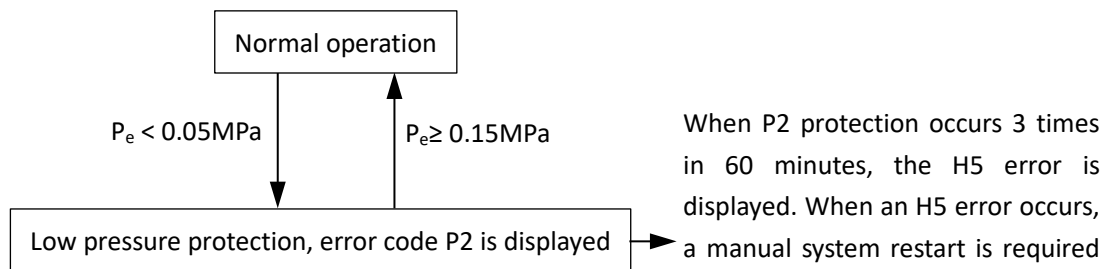

Notes:

1. P<sub>e</sub>: Suction pressure

When P2 protection occurs 3 times in 60 minutes, the H5 error is displayed. When an H5 error occurs, a manual system restart is required before the system can resume operation.

### 5.3 Discharge Temperature Protection Control

This control protects the compressors from abnormally high temperatures and transient spikes in temperature. It is performed for each compressor.

Figure 3-5.3: Discharge temperature protection control

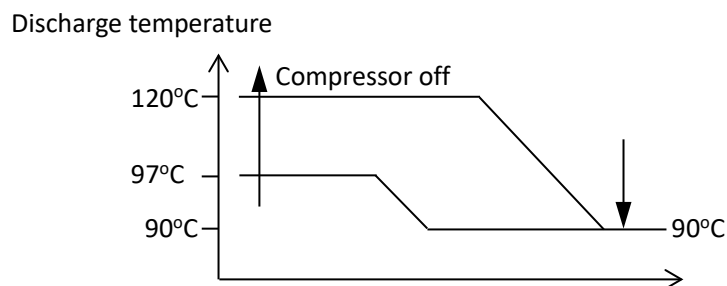

When the discharge temperature rises above 120°C the system displays P4 protection and all units stop running. When P4 protection occurs 3 times in 100 minutes, the H6 error is displayed. When an H6 error occurs, a manual system restart is required before the system can resume operation.

## 5.4 Compressor and Inverter Module Protection Control

This control protects the compressors from abnormally high currents and protects the inverter modules from abnormally high temperatures. It is performed for each compressor and inverter module.

Figure 3-5.4: Compressor current protection control

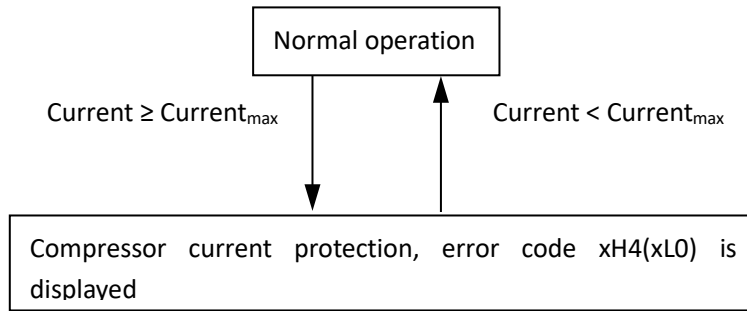

Compressor model	LNB53	LNB65
Current <sub>max</sub>	45	51

Figure 3-5.5: Inverter module temperature protection control

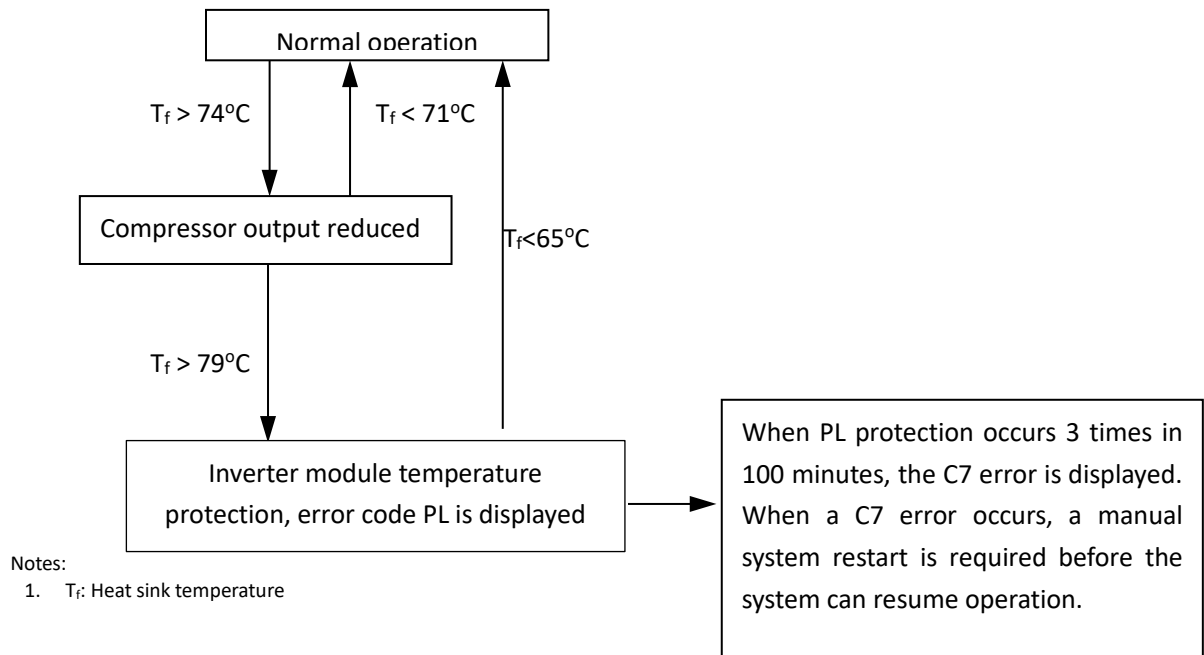

- Notes:
1.  $T_f$ : Heat sink temperature

## 6 Special Control

### 6.1 Outdoor Unit Duty Cycling

In systems with multiple outdoor units, outdoor unit duty cycling is used to prevent compressor burn out due to unbalanced oil levels between outdoor units.

Timing of outdoor unit duty cycling:

- After oil return operation.
- On restart following compressor stop after set temperatures achieved.

Figure 3-6.1 shows an example of duty cycling in a system with 3 outdoor units.

Figure 3-6.1: Duty cycling in a system with 3 outdoor units<sup>1</sup>

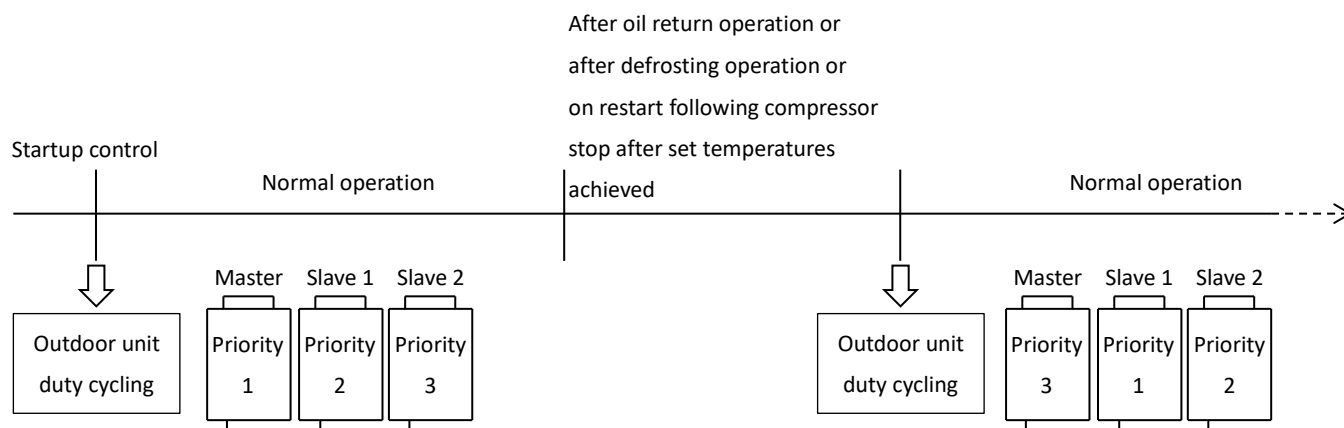

Notes:

1. The address settings on the outdoor unit main PCBs for "master unit", "slave unit 1", and "slave unit 2" do not change.



## 6.2 Oil Return Operation

In order to prevent compressors from running out of oil, the oil return operation is conducted to recover oil that has flowed out of the compressor(s) and into the piping system. This operation is performed for all units including units that are in standby. When the outdoor unit is running in oil return, the digital display on outdoor main PCB will display “d0”.

Timing of oil return operation:

- When the initial cumulative operating time reaches 140 minutes and then every 8 hours.

Tables 3-6.1 and 3-6.2 show component control during oil return operation in cooling mode.

Table 3-6.1: Outdoor unit component control during oil return operation in cooling mode

Component	Wiring diagram label	8-12HP	14-16HP	18-22HP	24-30HP	Control functions and states
Inverter compressor A	BP1	●	●	●	●	Fixed frequency
Inverter compressor B	BP2			●	●	
DC fan motor A	FAN1	●	●	●	●	Controlled according to discharge pressure
DC fan motor B	FAN2			●	●	
Electronic expansion valve A	EXVA	●	●	●	●	Position 480 (steps)
Solenoid valve (Liquid injection)	SV2	●	●	●	●	Normal control
Solenoid valve (oil balance)	SV4	●	●	●	●	Normal control
Solenoid valve (refrigerant bypass)	SV7	●	●	●	●	Normal control

Table 3-6.2: Indoor unit component control during oil return operation in cooling mode

Component	Unit state	Control functions and states
Fan	Thermo on	Remote controller setting
	Standby	Off
	Thermo off	Off
Electronic expansion valve	Thermo on	Normal control
	Standby	300 (steps)
	Thermo off	300 (steps)

# Part 4

# Field Settings

<b>1</b>	<b>Outdoor Unit Field Settings .....</b>	<b>34</b>
----------	------------------------------------------	-----------

# 1 Outdoor Unit Field Settings

## 1.1 PCB Switches and Switch Settings

Figure 4-1.1: Outdoor unit main PCB switches

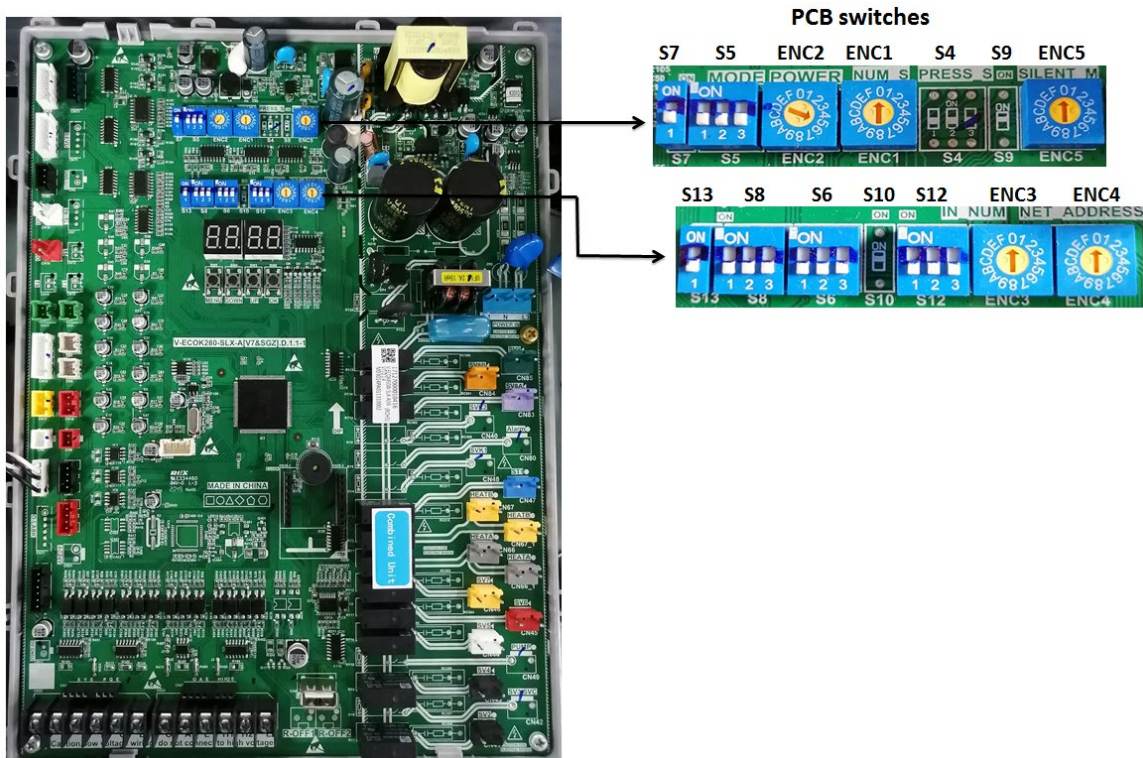



























Table 4-1.1: Outdoor unit main PCB switch settings

Switch	Setting	Switch positions <sup>1</sup>	Description
S4 <sup>2</sup>	Static pressure	ON	Standard static pressure (default)
		ON	Low static pressure mode (reserved)
		ON	Medium static pressure mode (reserved)
		ON	High static pressure mode (reserved)
		ON	Super high static pressure mode (reserved)
S5	Priority mode	ON	Reserved
S6-1	Reserved	ON	Reserved
S6-2	Clear indoor unit addresses	ON	No action (default)
		ON	Clear indoor unit addresses
S6-3	Addressing mode	ON	Auto addressing (default)
		ON	Manual addressing
S8-1	Reserved	ON	Reserved

Table 4-1.1: Outdoor unit main PCB switch settings (continued)

Switch	Setting	Switch positions <sup>1</sup>	Description
S8-2 	Start-up time	ON 	Start-up time is 12 minutes (default)
		ON 	Start-up time is 7 minutes
S8-3 	Reserved	ON 	Reserved
S7 	Reserved	ON 	Reserved
S9 <sup>2</sup> 	Reserved	ON 	Reserved
ENC1 	Outdoor unit address		Only 0, 1, 2 should be selected (default is 0) 0 is for master unit; 1 and 2 are for slave units
ENC2 	Outdoor unit capacity <sup>3</sup>		Only 0, 1, 2, 3, 4, 5, 6, 7, 8, 9, A, B, C should be selected 0: 8HP; 1: 10HP; 2: 12HP; 3: 14HP; 4: 16HP; 5: 18HP; 6: 20HP; 7: 22HP; 8: 24HP; 9: 26HP; A: 28HP; B:30HP
ENC4 	Network address		Only 0, 1, 2, 3, 4, 5, 6, 7 should be selected (default is 0)
ENC3  S12 	Number of indoor units	 ON 	The number of indoor units is in the range 0-15 0-9 on ENC3 indicate 0-9 indoor units; A-F on ENC3 indicate 10-15 indoor units
		 ON 	The number of indoor units is in the range 16-31 0-9 on ENC3 indicate 16-25 indoor units; A-F on ENC3 indicate 26-31 indoor units
		 ON 	The number of indoor units is in the range 32-47 0-9 on ENC3 indicate 32-41 indoor units; A-F on ENC3 indicate 42-47 indoor units
		 ON 	The number of indoor units is in the range 48-63 0-9 on ENC3 indicate 48-57 indoor units; A-F on ENC3 indicate 58-63 indoor units
ENC5 	Silent mode <sup>4</sup>	0	Night silent time is 6h/10h (default)
		1	Night silent time is 6h/12h
		2	Night silent time is 8h/10h
		3	Night silent time is 8h/12h
		4	No silent mode
		5	Silent mode 1 (only limit max. fan speed)
		6	Silent mode 2 (only limit max. fan speed)
		7	Silent mode 3 (only limit max. fan speed)
		8	Super silent mode 1 (limit max. fan speed and compressor frequency)
		9	Super silent mode 2 (limit max. fan speed and compressor frequency)
A	Super silent mode 3 (limit max. fan speed and compressor frequency)		
B	Super silent mode 4 (limit max. fan speed and compressor frequency)		
F	Set silent mode via centralized controller		

## Notes:

1. Black denotes the switch position.
2. Switches S4 and S9 are for customize, the standard unit's PCB don't have these two switches.
3. Switch ENC2 is factory-set and its setting should not be changed.
4. Refer to Part 4, 1.2.1 "Silent mode setting".

## 1.2 Modes Set on Main PCB

### 1.2.1 Silent time setting

#### 1.2.1.1 Night silent time setting

Night silent mode is activated X hours after the peak daytime temperature, and is deactivated after Y hours, where X and Y are as specified in Table 4-1.2.

Table 4-1.2: Night silent time setting

Switch	Switch positions	Description	X	Y
 ENC5	0	Night silent time is 6h/10h (default)	6	10
	1	Night silent time is 6h/12h	6	12
	2	Night silent time is 8h/10h	8	10
	3	Night silent time is 8h/12h	8	12

Figure 4-1.4: Night silent mode example (default setting, 6h/10h)



### 1.2.1.2 Silent mode setting

In silent mode 1 / 2 / 3 and night silent mode, the outdoor fan speed decreases gradually. In super silent mode 1 / 2 / 3 / 4, not only the fan speed decreases gradually, but also the compressor frequency decreases gradually.

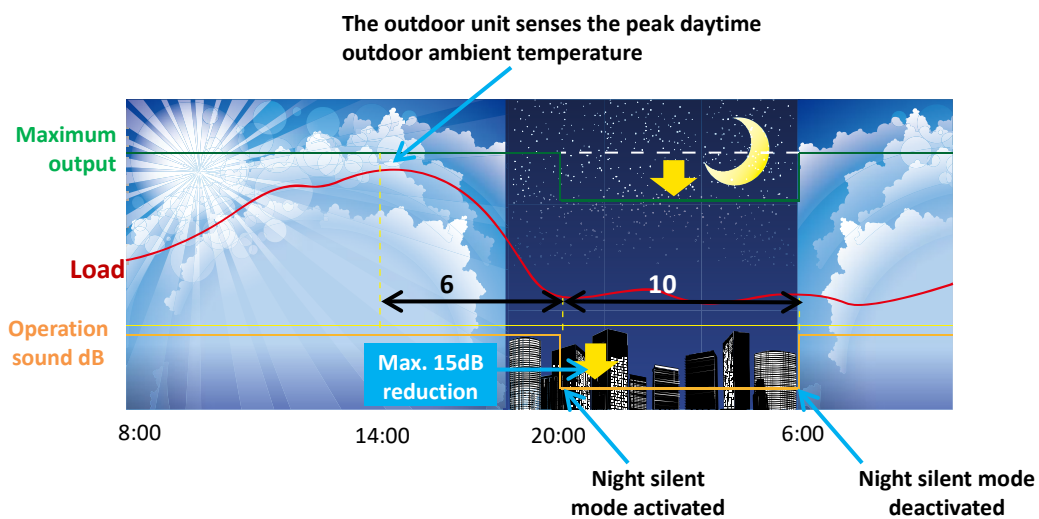
Table 4-1.3: Silent mode setting

Switch	Switch positions	Description
 ENC5	5	Silent mode 1 (only limit max. fan speed)
	6	Silent mode 2 (only limit max. fan speed)
	7	Silent mode 3 (only limit max. fan speed)
	8	Super silent mode 1 (limit max. fan speed and compressor frequency)
	9	Super silent mode 2 (limit max. fan speed and compressor frequency)
	A	Super silent mode 3 (limit max. fan speed and compressor frequency)
	B	Super silent mode 4 (limit max. fan speed and compressor frequency)

### 1.2.1.3 Maximum fan speed and capacity output control in different silent mode

Table 4-1.4: Maximum fan speed and capacity output control in different silent mode

ENC5 Switch positions	Description	Max. fan speed index <sup>1</sup>							Max. capacity output
		8-10HP	12HP	14-16HP	18HP	20-22HP	24-26HP	28-30HP	
0	Night silent time is 6h/10h (default)	28	28	30	29	29	31	31	100%
1	Night silent time is 6h/12h								
2	Night silent time is 8h/10h								
3	Night silent time is 8h/12h								
4	No silent mode	29	30	33	33	35	33	35	
5	Silent mode 1	28	28	30	31	31	31	31	
6	Silent mode 2	26	26	28	29	29	29	29	
7	Silent mode 3	24	24	27	27	27	27	27	
8	Super silent mode 1	28	28	29	23	23	28	28	80%
9	Super silent mode 2	27	27	28	22	22	27	27	70%
A	Super silent mode 3	26	26	27	21	21	26	26	60%
B	Super silent mode 4	25	25	26	20	20	25	25	50%

Notes:

1. Fan speed (rpm) for different fan speed index refers to Table 3-4.2 in Part 3, 4.6 "Outdoor Fan Control".
2. If the system pressure is over 3.5MPa, the system exits silent mode automatically.

# Part 5

# Electrical Components and Wiring Diagrams

1	Outdoor Unit Electric Control Box Layout .....	39
2	Outdoor Unit Main PCB.....	41
3	Wiring Diagrams.....	51

# 1 Outdoor Unit Electric Control Box Layout

8-16HP

Figure 5-1.1: 8-16HP top layer of electric control box

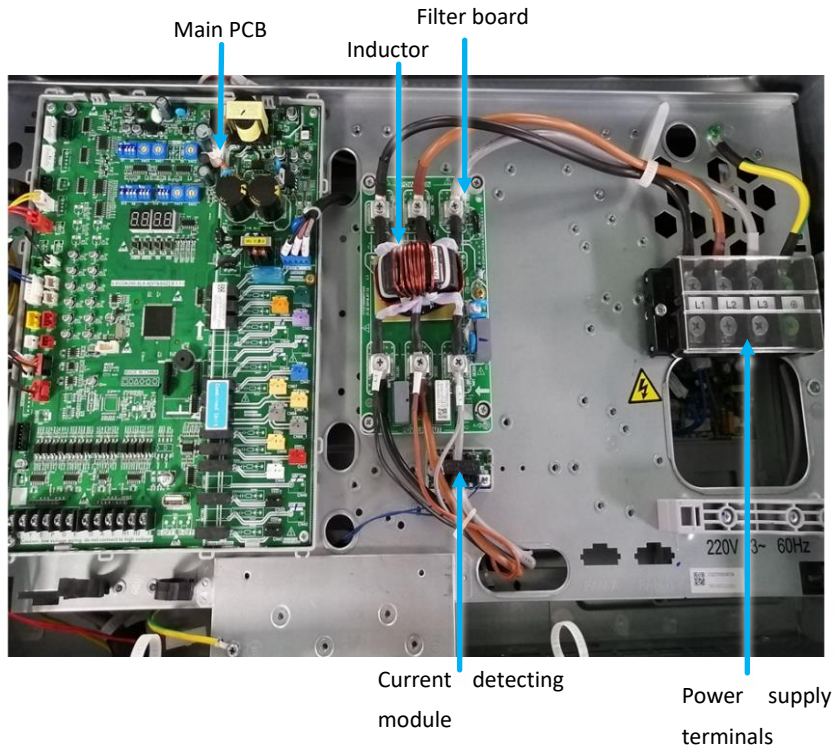

Figure 5-1.2: 8-16HP bottom layer of electric control box

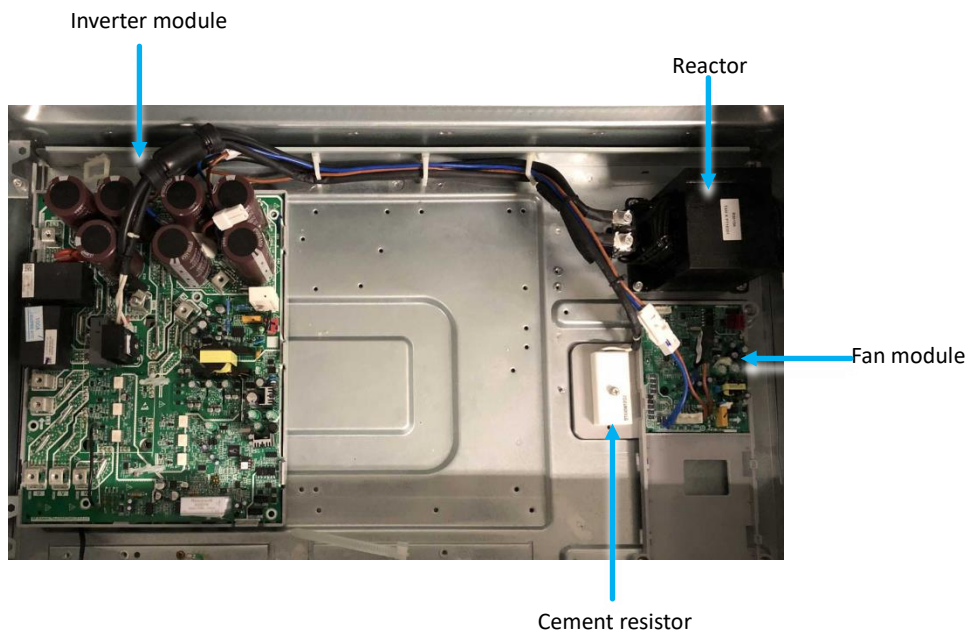



Figure 5-1.3: 18-30HP top layer of electric control box

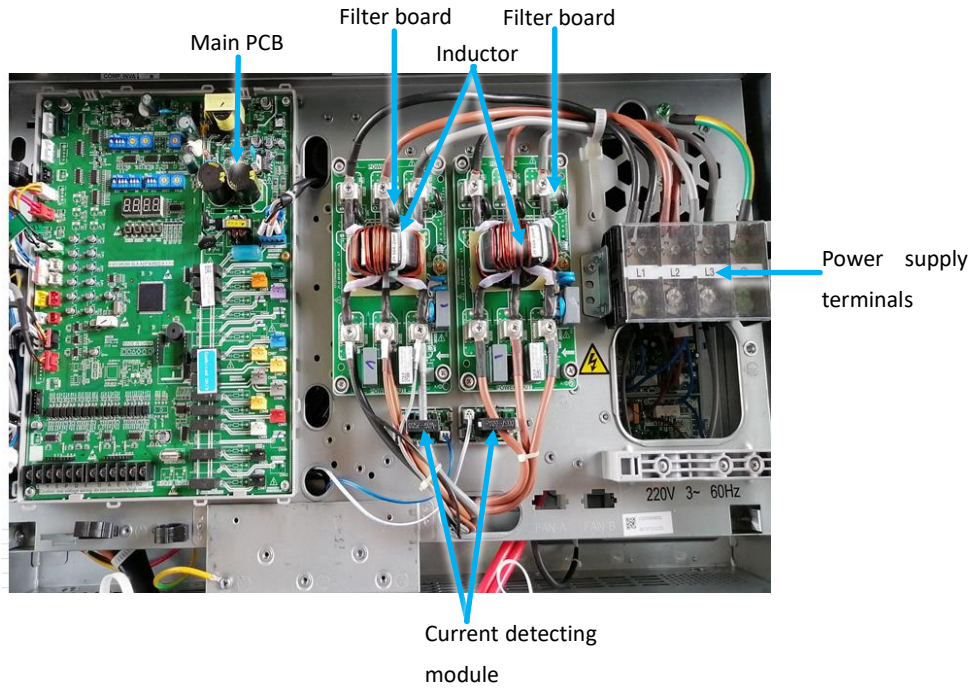

Figure 5-1.4: 18-30HP bottom layer of electric control box

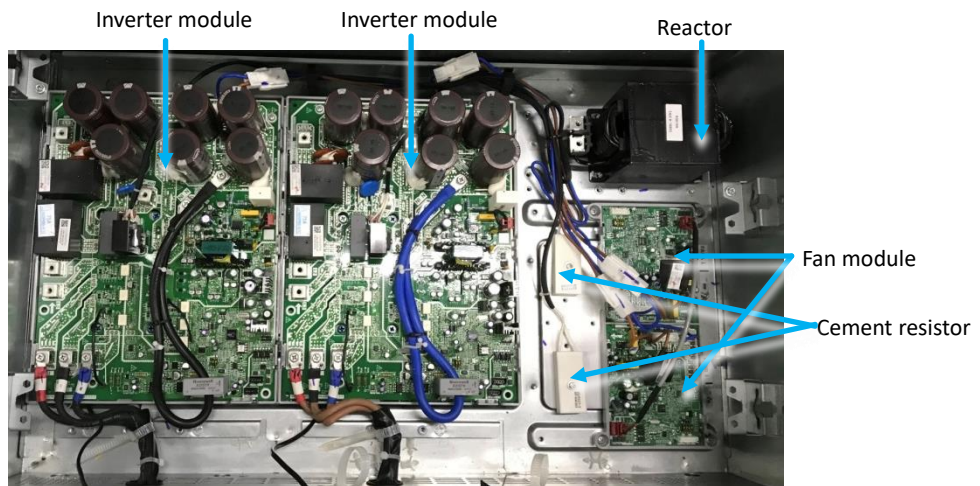
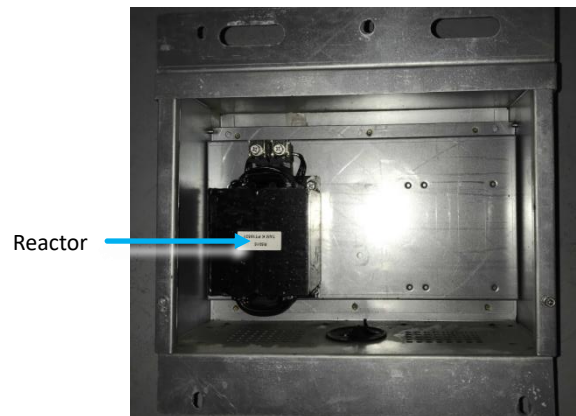

Figure 5-1.5 18-30HP auxiliary electric control box



## 2 Outdoor Unit Main PCB

### 2.1 Ports

Figure 5-2.1: Outdoor unit main PCB ports<sup>1</sup>

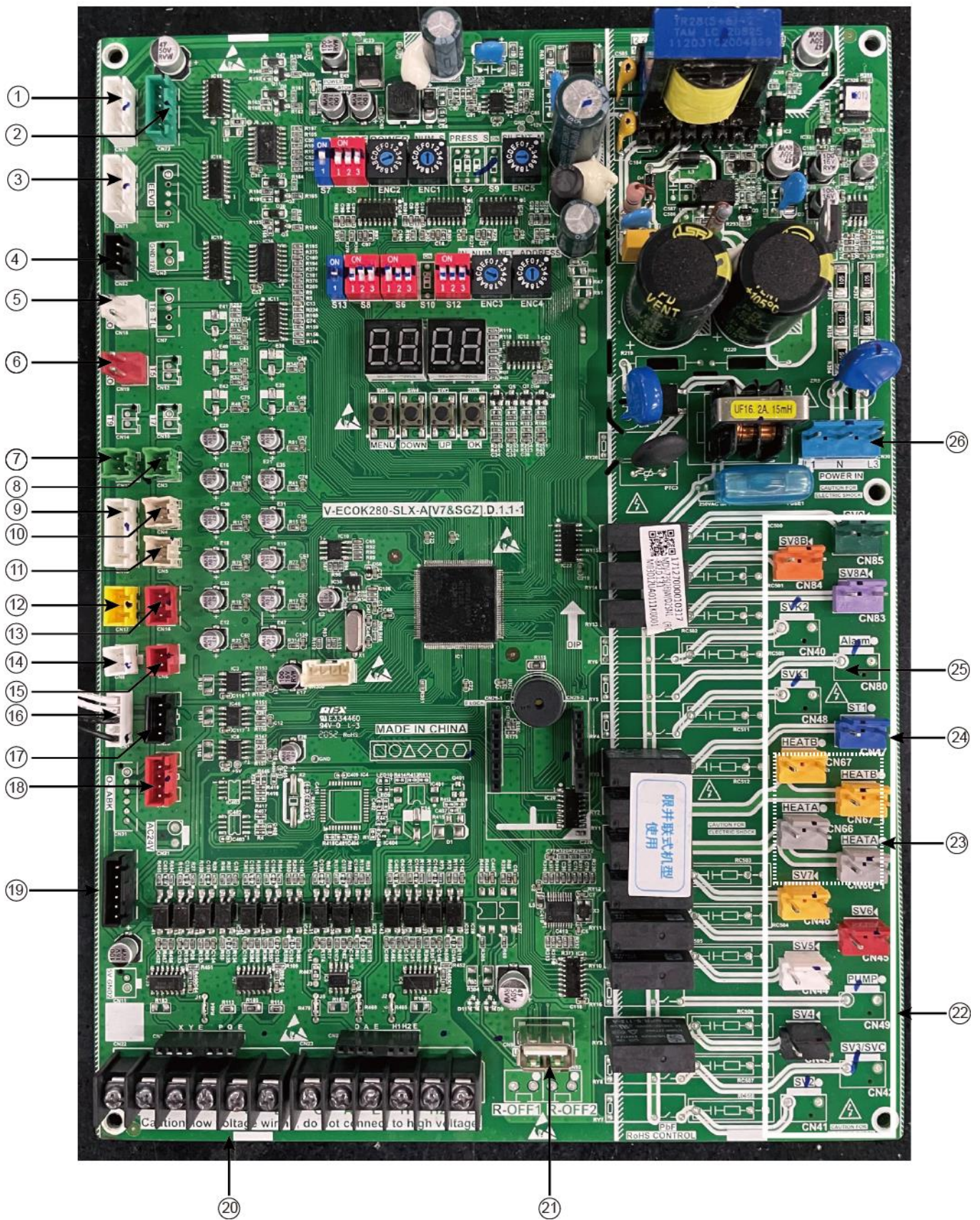

Notes:

1. Label descriptions are given in Table 5-2.1.

Table 5-2.1: Main PCB ports

Label in Figure 5-2.1	Port code	Content	Port voltage
1	CN70	EEVA drive port	0V or 12V DC
2	CN72	EEVC drive port	0V or 12V DC
3	CN71	EEVB drive port	0V or 12V DC
4	CN82	Control port of relay for AC filter board	0V or 12V DC
5	CN18	High pressure switch and discharge temperature switch(es) connections	0V or 5V DC
6	CN19	Low pressure switch connection	0V or 5V DC
7	CN13	Inverter module temperature sensor B connection	0-5V DC (varying)
8	CN3	Inverter module temperature sensor A connection	0-5V DC (varying)
9	CN15	Inverter compressor A and B current sensor connections	0-7.8V AC (varying)
10	CN4	Compressor top temperature sensor (single compressor units) or compressor A compressor top temperature sensor (dual compressor units) connection	0-5V DC (varying)
11	CN5	Discharge pipe temperature sensor (single compressor units) or compressor B compressor top temperature sensor (dual compressor units) connection	0-5V DC (varying)
12	CN17	High pressure sensor connection	0-5V DC (varying)
13	CN16	Reserved	/
14	CN8	Plate heat exchanger inlet temperature sensor connection	0-5V DC (varying)
15	CN6	Plate heat exchanger outlet temperature sensor connection	0-5V DC (varying)
16	CN1	Outdoor ambient temperature sensor and outdoor heat exchanger temperature sensor connections	0-5V DC (varying)
17	CN26	Communication port to compressor drive board	2.5-2.7V DC
18	CN27	Communication port to fan drive board	2.5-2.7V DC
19	CN28	Reserved	/
20	CN22、CN23	Communication port	2.5-2.7V DC
21	CN9	USB UPGRADE	
22	CN41、CN43、CN46	Solenoid valve drive ports	220V AC
23	CN66-CN67	Power supply to compressor crankcase heater	220V AC
24	CN47	Four-way valve drive ports	220V AC
25	CN80	Alarm signal output port (reserved)	220V AC
26	CN30	Power input of main board	220V AC between L1/L2/L3

## 2.2 Components

### 2.2.1 Layout

Figure 5-2.2: Outdoor unit main PCB components

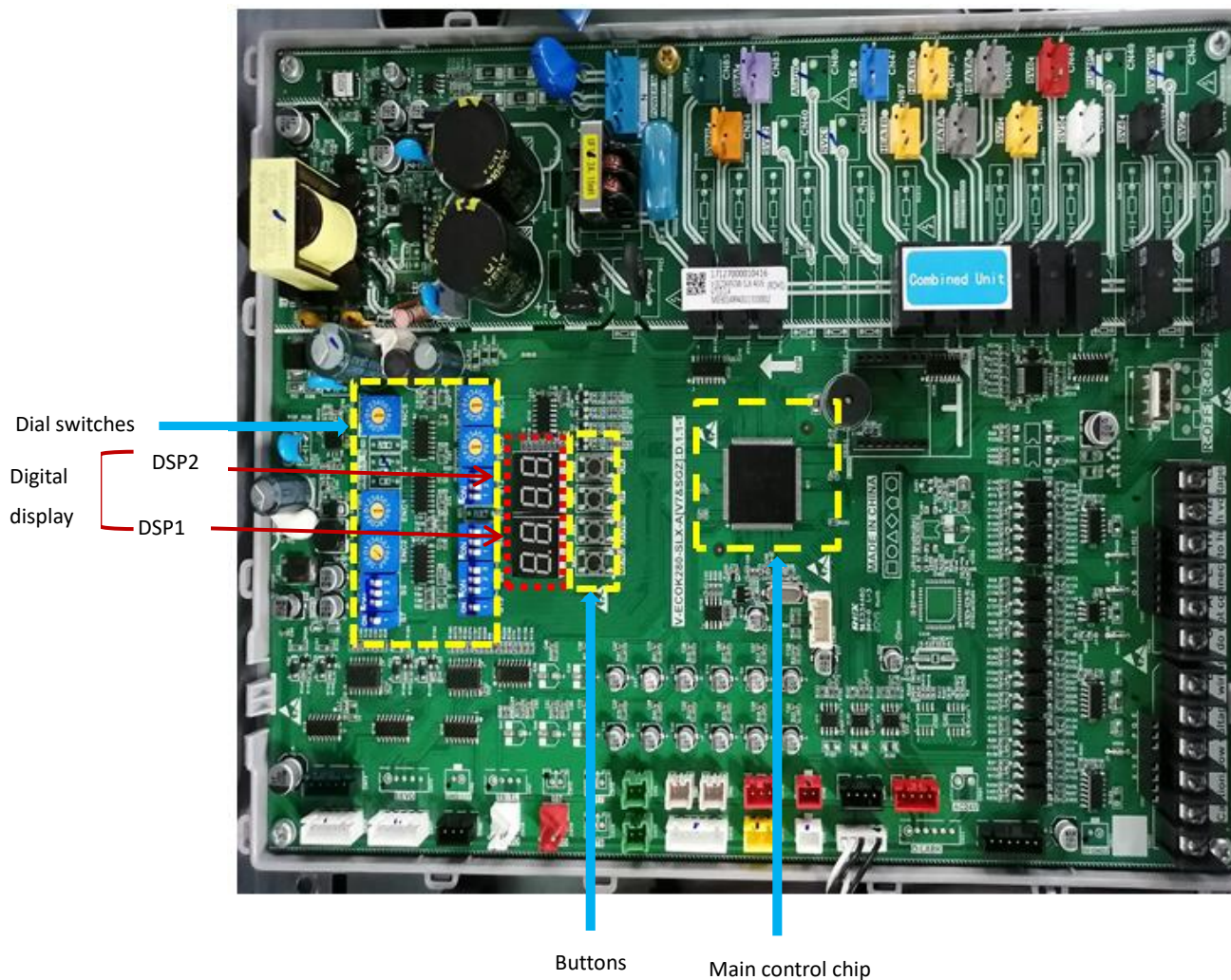

### 2.2.2 Function of buttons SW3 to SW6

Table 5-2.2: Function of buttons SW3 to SW6

Button	Function
SW3 (UP)	In menu mode: previous and next buttons for menu modes.
SW4 (DOWN)	Not in menu mode: previous and next buttons for system check information.
SW5 (MENU)	Enter / exit menu mode.
SW6 (OK)	Confirm to enter specified menu mode.

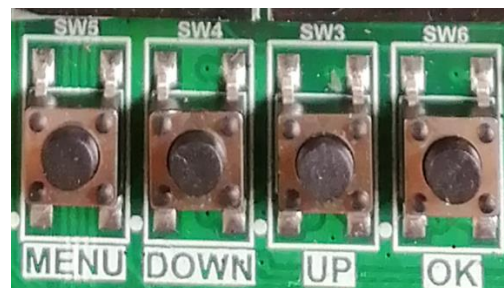

### 2.2.3 Menu mode

Only master unit has the full menu functions, slaves units only have error codes check and cleaning functions.

1. Long press SW5 "MENU" button for 5 seconds to enter menu mode, and the digital display displays "n1";
2. Press SW3 / SW4 "UP / DOWN" button to select the first level menu "n1", "n2", "n3", "n4" or "nb";
3. Press SW6 "OK" button to enter specified first level menu, for example, enter "n4" mode;
4. Press SW3 / SW4 "UP / DOWN" button to select the second level menu from "n41" to "n47";
5. Press SW6 "OK" button to enter specified second level menu, for example, enter "n43" mode;

#### Menu mode selection flowchart:

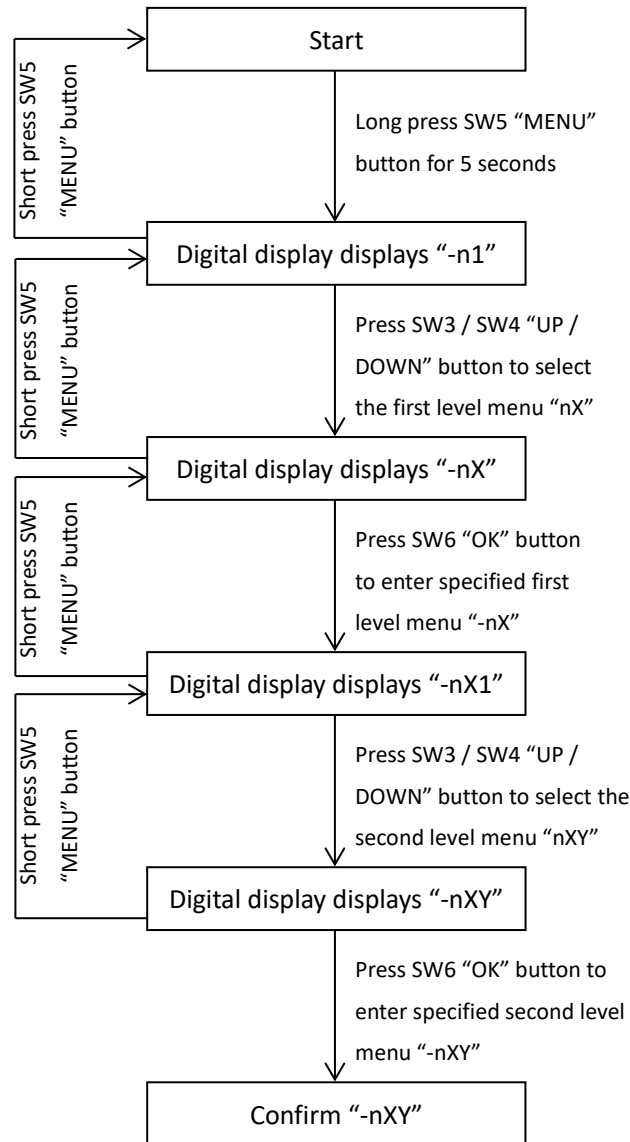

## Menu mode function:

Table 5-2.3: Menu mode function

Digital display content	Menu mode	Remarks
n14	Debug mode	Only available for the master unit (all indoor units running in cooling mode)
n16	Maintenance mode	Only available for the master unit, the system does not check the indoor units' number.
n24	Reserved	
n25	Reserved	
n26	Backup run	Only available for outdoor unit with two compressors. If one of the two compressors is fail, the other compressor will keep running for up to 4 days and then stop automatically.
n27	Vacuum mode	It is only used in maintenance process. The digital display displays "R006", all solenoid valves are open and EXVs are open to the maximum steps.
n31	History error codes	Display recent ten history error codes
n32	Cleaning history error codes	
n33	Reserved	
n34	Factory reset	Only available for the master unit
n41	Power limitation mode 1	Only available for the master unit, 100% capacity output
n42	Power limitation mode 2	Only available for the master unit, 90% capacity output
n43	Power limitation mode 3	Only available for the master unit, 80% capacity output
n44	Power limitation mode 4	Only available for the master unit, 70% capacity output
n45	Power limitation mode 5	Only available for the master unit, 60% capacity output
n46	Power limitation mode 6	Only available for the master unit, 50% capacity output
n47	Power limitation mode 7	Only available for the master unit, 40% capacity output
nb1	Fahrenheit degree setting (°F)	Only available for the master unit
nb2	Celsius degree setting (°C)	Only available for the master unit
nb3	Exit auto power save mode <sup>1</sup>	Only available for the master unit
nb4	Enter auto power save mode <sup>1</sup>	Only available for the master unit
nb5	Auto snow-blowing mode 1 (customized)	According to outdoor ambient temperature (T4), the outdoor fan(s) periodically stop for 15 minutes and run for 2 minute
nb6	Auto snow-blowing mode 2 (customized)	According to outdoor ambient temperature (T4), the outdoor fan(s) periodically stop for 30 minutes and run for 2 minute
nb7	Exit auto snow-blowing mode	
nb8	VIP address setting	The digital display will display "1dXX", "XX" stands for VIP address, use UP / DOWN button to change the VIP address and press OK button to confirm the specified VIP address.
nF1	Reserved	
nF2	Reserved	

Notes:

1. Auto power save mode means EMS mode, the evaporating temperature (in cooling) is automatically adjusted according to both indoor and outdoor temperature to maximize the comfort and energy efficiency. Exit auto power save mode, the evaporating temperature (in cooling) is fixed.

## How to exit specified menu mode:

Table 5-2.4: Exit specified menu mode method:

Menu mode	Manual exit method	Automatic exit method	System restart
Debug mode	Long press SW6 "OK" button when the digital display is not in menu selection state	After running 120 minutes	Invalid
Maintenance mode	/	After running 60 minutes	Invalid
Backup run	/	After running 4 days or both two compressors are failed	Invalid
Vacuum mode	Long press SW6 "OK" button when the digital display is not in menu selection state	After running 8 hours	Invalid
Power limitation mode	Select power limitation mode 1 "n41"	/	Valid
Auto power save mode	Select "nb3"	/	Valid
Auto snow-blowing mode 1 (2)	Select "nb7"	/	Valid
VIP address setting	/	/	Valid
°F / °C setting	/	/	Valid

### 2.2.4 UP / DOWN system check button

Before pressing UP or DOWN button, allow the system to operate steadily for more than an hour. On pressing UP or DOWN button, the parameters listed in Table 5-2.5 will be displayed in sequence.

Table 5-2.5: System check

DSP1 content	Parameters displayed on DSP2	Remarks
0.--	Unit address	Master unit: 0; slave units: 1, 2
1.--	Unit capacity	Refer to Note 1
2.--	Number of outdoor units	Displayed on master unit PCB only
3.--	Number of indoor units as set on PCB	Displayed on master unit PCB only
4.--	Total capacity of outdoor unit	Only available for master unit, displayed on slave units has no sense
5.--	Total capacity requirement of indoor units	Displayed on master unit PCB only
6.--	Total corrected capacity requirement of master units	Displayed on master unit PCB only
7.--	Operating mode	Refer to Note 2
8.--	Outdoor unit actual operating capacity	
9.--	Fan A speed index	Refer to Note 3
10.--	Fan B speed index	Refer to Note 3
11.--	Indoor heat exchanger pipe (T2/T2B) temperature (°C)	Actual value = value displayed
12.--	Main heat exchanger pipe (T3) temperature (°C)	Actual value = value displayed
13.--	Outdoor ambient (T4) temperature (°C)	Actual value = value displayed
14.--	Inverter compressor A discharge temperature (°C)	Actual value = value displayed
15.--	Inverter compressor B discharge temperature (°C)	Actual value = value displayed
16.--	Inverter module A heatsink temperature (°C)	Actual value = value displayed
17.--	Inverter module B heatsink temperature (°C)	Actual value = value displayed
18.--	Discharge superheat degree (°C)	Actual value = value displayed
19.--	Reserved	
20.--	Reserved	
21.--	EXVA position	Refer to Note 4
22.--	Compressor discharge pressure (MPa)	Actual value = value displayed × 0.1
23.--	Reserved	
24.--	Number of indoor units currently in communication with master unit	Actual value = value displayed
25.--	Number of indoor units currently operating	Displayed on master unit PCB only
26.--	Reserved	
27.--	Silent mode	Refer to Note 5
28.--	Static pressure mode	Refer to Note 6
29.--	Reserved	
30.--	Reserved	
31.--	DC voltage A	Actual value = value displayed × 10
32.--	DC voltage B	Actual value = value displayed × 10
33.--	Reserved	

Table continued on next page ...

Table 5-2.5: System check (continued)

DSP1 content	Parameters displayed on DSP2	Remarks
34.--	Address of VIP indoor unit	
35.--	Reserved	
36.--	Reserved	
37.--	Refrigerant quantity	Refer to Note 7
38.--	Reserved	
39.--	Power mode	Refer to Note 8
40.--	Most recent error or protection code	"--" is displayed if no error or protection events have occurred since start-up
--	--	End

- Notes:
- Outdoor unit capacity setting:
    - 0: 8HP; 1: 10HP; 2: 12HP; 3: 14HP; 4: 16HP; 5: 18HP; 6: 20HP; 7: 22HP; 8: 24HP; 9: 26HP; A: 28HP; B: 30HP; C: 30HP.
  - Operating mode:
    - 0: off; 2: cooling; 3: null; 4: forced cooling.
  - The fan speed index is related to the fan speed in rpm and can take any integer value in the range 1 (slowest) to 37 (fastest).
  - 480P: steps = value displayed × 4; 3000P: steps = value displayed × 24.
  - Silent mode:
    - 0: night silent time 6h/10h; 1: night silent time 6h/12h; 2: night silent time 8h/10h; 3: night silent time 8h/12h; 4: no silent mode; 5: silent mode 1; 6: silent mode 2; 7: silent mode 3; 8: super silent mode 1; 9: super silent mode 2; 10: super silent mode 3; 11: super silent mode 4.
  - Static pressure mode:
    - 0: standard static pressure; 1: low static pressure; 2: medium static pressure; 3: high static pressure; 4: super high static pressure.
  - Refrigerant quantity:
    - 0: normal; 1: slightly excessive; 2: significantly excessive; 3: slightly insufficient; 4: significantly insufficient; 5: critically insufficient.
  - Power mode:
    - 0: 100% capacity output; 1: 90% capacity output; 2: 80% capacity output; 3: 70% capacity output; 4: 60% capacity output; 5: 50% capacity output; 6: 40% capacity output; 10: auto power save mode, 100% capacity output; 11: auto power save mode, 90% capacity output; 12: auto power save mode, 80% capacity output; 13: auto power save mode, 70% capacity output; 14: auto power save mode, 60% capacity output; 15: auto power save mode, 50% capacity output; 16: auto power save mode, 40% capacity output;

## 2.2.5 Digital display output

Table 5-2.6: Digital display output in different operating states

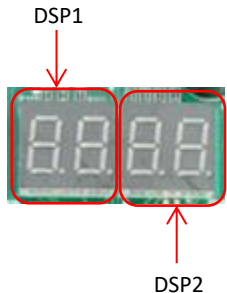
Outdoor unit state		Parameters displayed on DSP1	Parameters displayed on DSP2	
Standby		Unit's address	The number of indoor units in communication with the outdoor units	
Normal operation	For single compressor units	--	Running speed of the compressor in rotations per second	
	For dual compressor units	Running speed of compressor A in rotations per second	Running speed of compressor B in rotations per second	
Error or protection		-- or placeholder	Error or protection code	
In menu mode		Refer to Table 5-2.3	Refer to Table 5-2.3	
System check		Refer to Table 5-2.5	Refer to Table 5-2.5	



### 3 Compressor Inverter Module

#### 3.1 Ports

Figure 5-3.1: Compressor inverter module ports<sup>1</sup> and components<sup>1</sup>

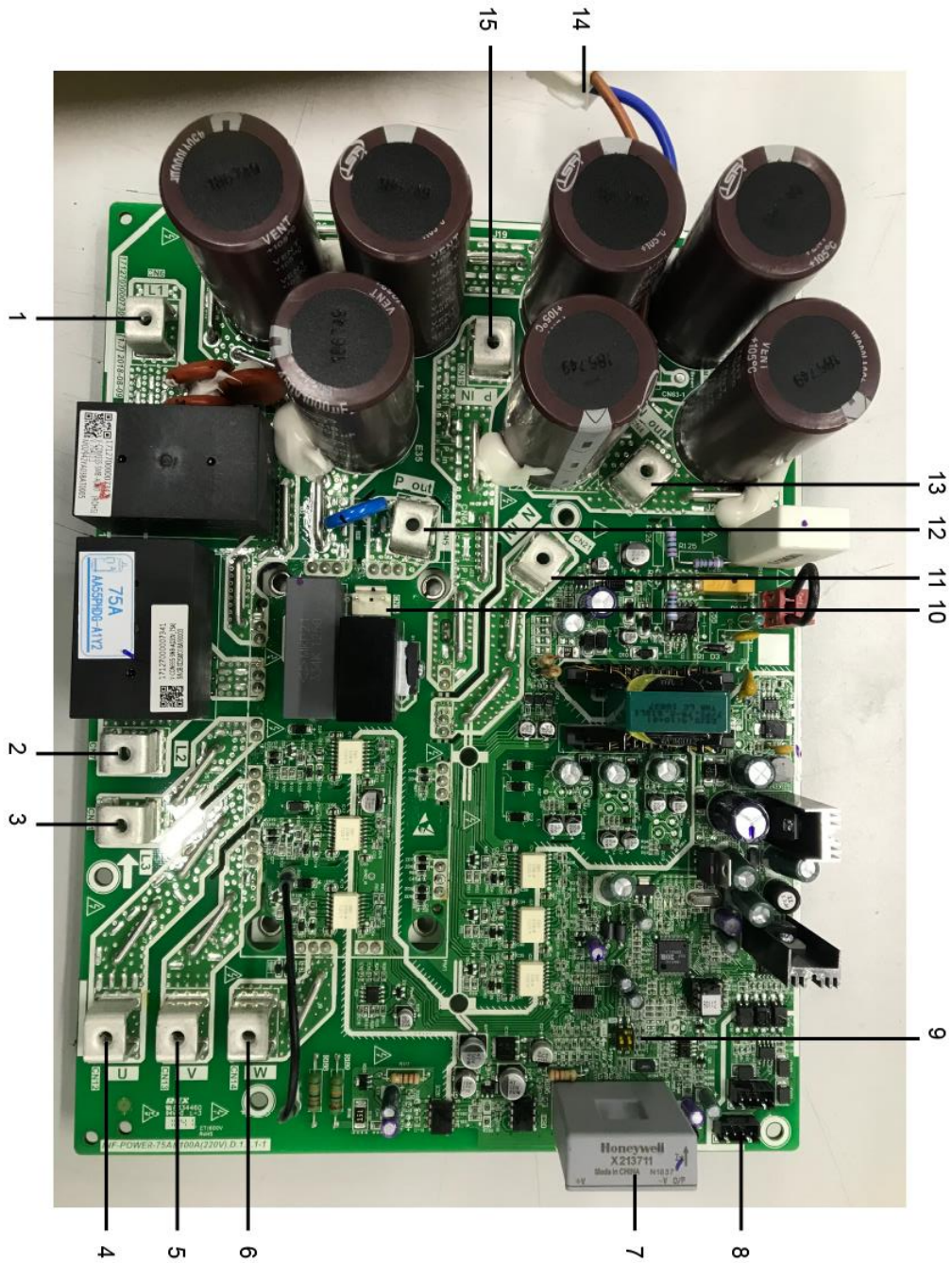

Notes:

1. Label descriptions are given in Table 5-3.1.

Table 5-3.1: Compressor inverter module ports and components

Label in Figure 5-3.1	Code	Content	Port voltage
1	CN6	Three phase power input of L1	Rated 220V AC of any two terminals
2	CN7	Three phase power input of L2	Rated 220V AC of any two terminals
3	CN11	Three phase power input of L3	Rated 220V AC of any two terminals
4	CN12	Three phase output of the inverter ,connected to the compressor	
5	CN13	Three phase output of the inverter ,connected to the compressor	
6	CN14	Three phase output of the inverter ,connected to the compressor	
7	IC17	DC-bus current sensor	/
8	CN8/CN9	Communication port to Main PCB	2.5-2.7V DC
9	S7	Address setting switch of the inverter module	/
10	CN15	Port to Snubber resistance	/
11	CN21	PIM Common terminal of the negative pole, connected to the DC-bus	/
12	CN5	Output of the three phase rectifier, Positive pole, connected to reactance	DC 310V to CN4 when 220V 3hp power input
13	CN4	Output of the three phase rectifier, Negative pole	/
14	/	Power terminal for DC fan inverter module	DC 310V when 220V 3hp input
15	CN19	PIM Common terminal of the positive pole, connected to reactance	DC 310V to CN21 when 220V 3hp power input
16	/	LED1/LED2	

## 3.2 Layout

### 3.2.1 LED indicators LED1 and LED2

Table 5-3.2: LED indicators LED1 and LED2

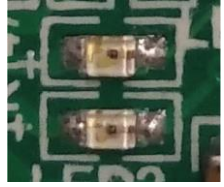

Indicator	LED indicator function and status	
LED 1	Inverter module operating indicator. Continuously on if the compressor is running normally and flashing if an inverter module error has occurred <sup>1</sup> .	
LED 2	Inverter module error indicator. Continuously on if an inverter module error has occurred <sup>1</sup> .	

Note:

1. If an inverter module error occurs, refer to Part 6, “Xh4 Troubleshooting”. The error code is displayed on the digital display.

### 3.2.2 Dial switch S7 setting

Dial switch S7 is used to set compressor inverter module A/B address. The compressor inverter module A/B location refers to the wiring diagram.

S7 on inverter module	Inverter module address
	0 for compressor inverter module A
	1 for compressor inverter module B

## 4 Fan Module

### 4.1 Ports

Figure 5-4.1: Compressor inverter module ports

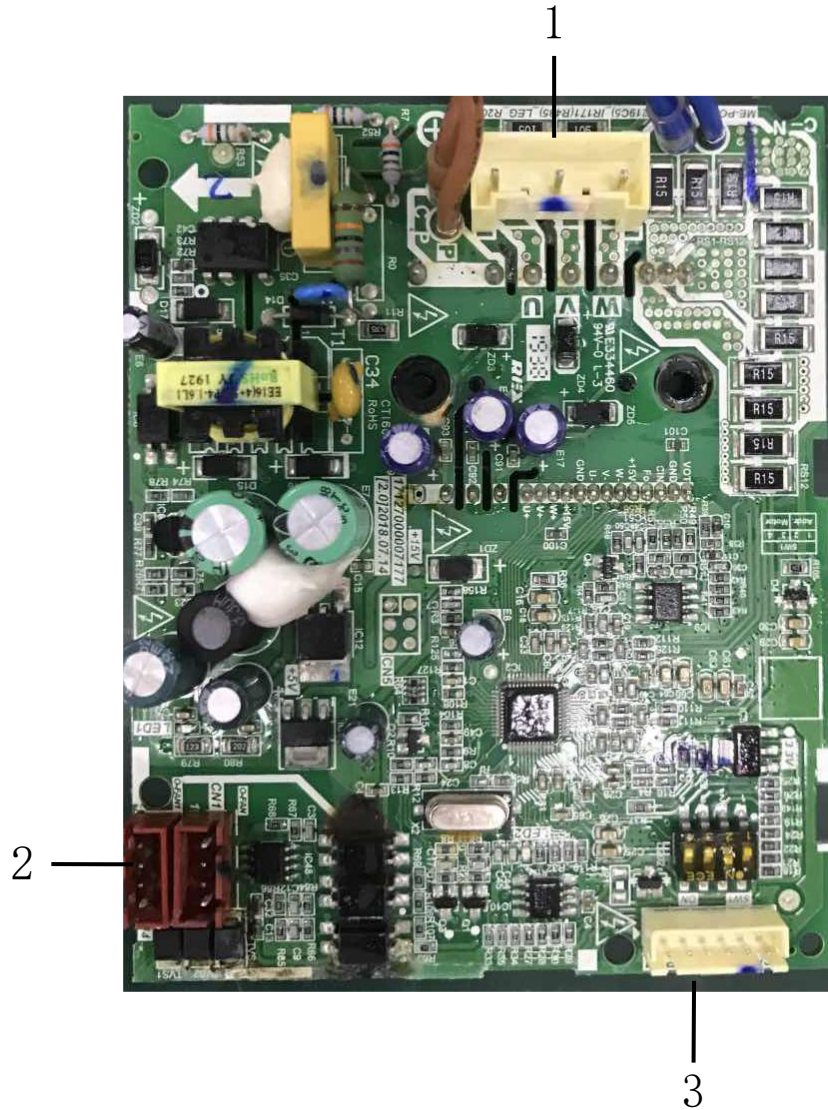



Table 5-4.1: Fan module PCB ports

Label in	Port code	Content	Port voltage
1	CN3	Connect to fan motor	/
2	CN1/CN4	Communication port to main board	0-5V DC (varying)
3	CN2	Program upgrade port	/

Notes:

- This dial switch is used to set fan module A/B address. The fan module A/B location refers to the wiring diagram.

Dial switch on fan module	Fan module address
	0 for fan module A
	1 for fan module B

# 5 Wiring Diagrams

## 8-16HP

Figure 5-5.1: 8-16HP wiring diagram

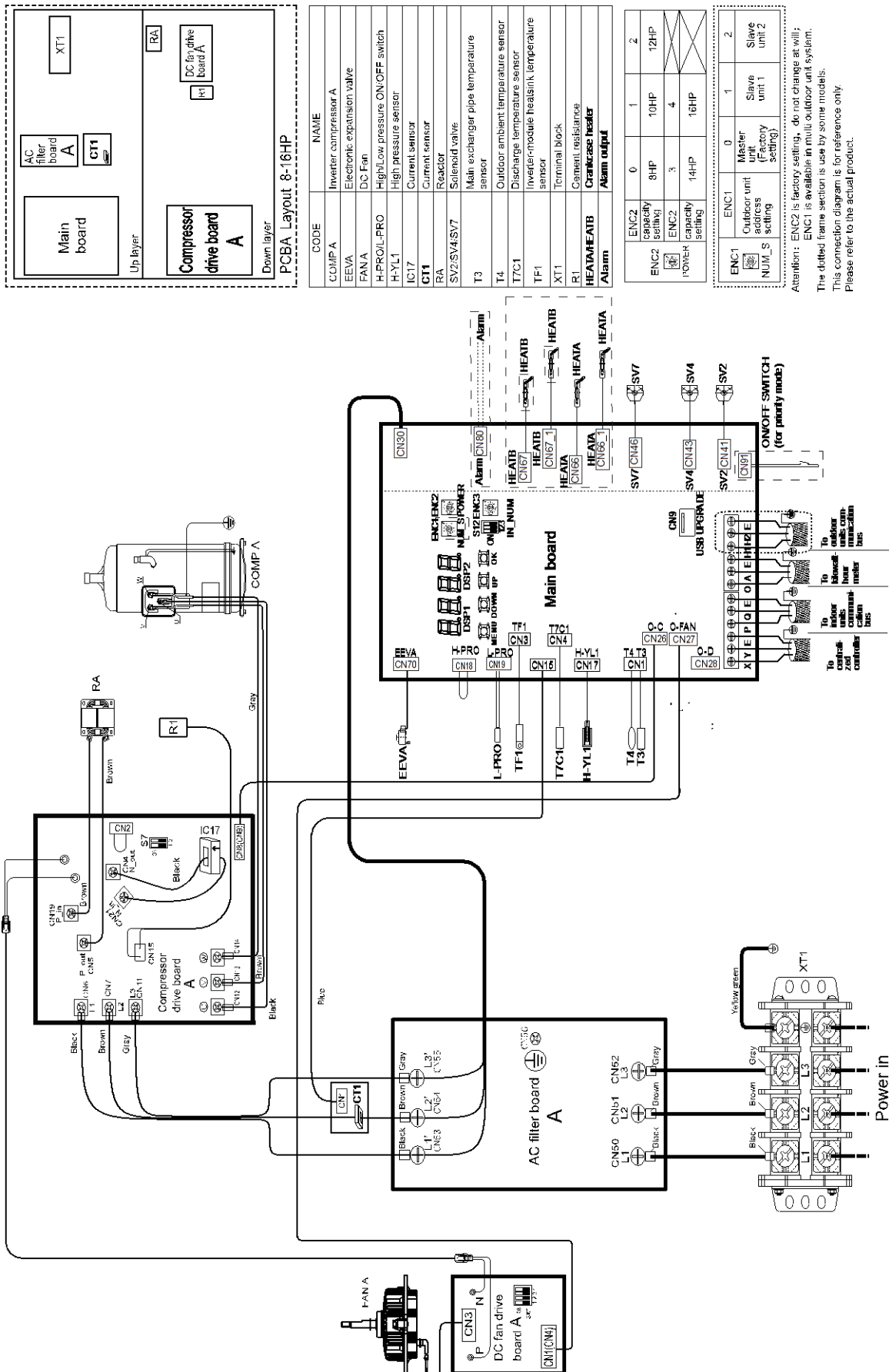

18-30HP

Figure 5-5.2: 18-30HP wiring diagram

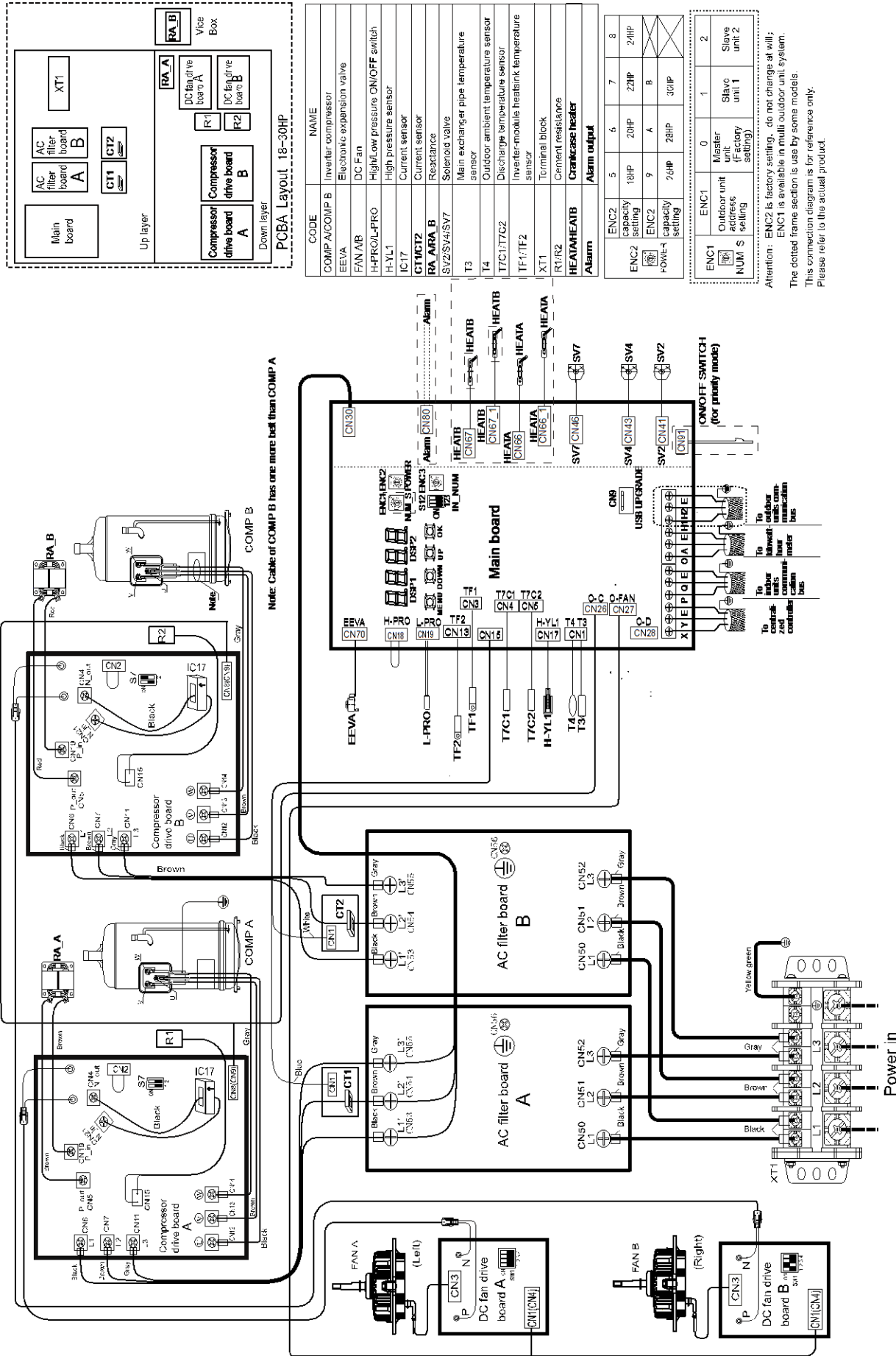

Attention: ENC2 is factory setting, do not change at will.  
 ENC1 is available in multi outdoor unit system.  
 The dotted frame section is used by some models.  
 This connection diagram is for reference only.  
 Please refer to the actual product.

# Part 6

# Diagnosis and Troubleshooting

<b>1</b>	<b>Error Code Table .....</b>	<b>55</b>
<b>2</b>	<b>Troubleshooting .....</b>	<b>56</b>
<b>3</b>	<b>Appendix to Part 6 .....</b>	<b>114</b>

# 1 Error Code Table

Table 6-1.1: Error code table

Error code <sup>1</sup>	Content	Remarks	Manual re-start required <sup>2</sup>
E0	Communication error between outdoor units	Only displayed on the slave unit with the error	No
E2	Communication error between indoor and master unit	Only displayed on the master unit	No
E4	Outdoor heat exchanger temperature sensor (T3) error or outdoor ambient temperature sensor (T4) error	Displayed on the unit with the error	No
E5	Abnormal power supply voltage	Displayed on the unit with the error	No
E7	Compressor top or discharge pipe temperature sensor (T7C1/2) error	Displayed on the unit with the error	Yes
E8	Outdoor unit address error	Displayed on the unit with the error	Yes
xE9	EEPROM mismatch	Displayed on the unit with the error	Yes
xF1	DC bus voltage error	Displayed on the unit with the error	No
F3	Plate heat exchanger cooling refrigerant outlet temperature sensor (T6B) error	Displayed on the unit with the error	No
F5	Plate heat exchanger cooling refrigerant inlet temperature sensor (T6A) error	Displayed on the unit with the error	No
xF6	Electronic expansion valve connection error	Displayed on the unit with the error Refer to Note 3	Yes
xH0	Communication error between main control chip and inverter driver chip	Displayed on the unit with the error	No
H2	Number of slave units detected by master unit has decreased	Only displayed on the master unit	No
H3	Number of slave units detected by master unit has increased	Only displayed on the master unit	No
xH4	Inverter module protection	Displayed on the unit with the error	Yes
H5	P2 protection appears three times in 60 minutes	Displayed on the unit with the error	Yes
H6	P4 protection appears three times in 100 minutes	Displayed on the unit with the error	Yes
H7	Number of indoor units detected by master unit not same as number set on main PCB	Only displayed on the master unit	No
H8	High pressure sensor error	Displayed on the unit with the error	No
H9	P9 protection appears ten times in 120 minutes	Displayed on the unit with the error	Yes
yHd	Slave unit malfunction	Only displayed on the master unit	No
C7	PL protection appears three times in 100 minutes	Displayed on the unit with the error	Yes
P1	Discharge pipe high pressure protection	Displayed on the unit with the error	No
P2	Suction pipe low pressure protection	Displayed on the unit with the error	No
xP3	Compressor current protection	Displayed on the unit with the error	No
P4	Discharge temperature protection	Displayed on the unit with the error	No
P5	Outdoor heat exchanger temperature protection	Displayed on the unit with the error	No
xP9	Fan module protection	Displayed on the unit with the error	No

Table continued on next page ...



Table 6-1.1: Error code table (continued)

Error code <sup>1</sup>	Content	Remarks	Manual re-start required <sup>2</sup>
xPL	Inverter module temperature protection	Displayed on the unit with the error	No
PP	Compressor discharge insufficient superheat protection	Displayed on the unit with the error	No
xL0	Inverter module protection	Displayed on the unit with the error	Yes
xL1	DC bus low voltage protection	Displayed on the unit with the error	Yes
xL2	DC bus high voltage protection	Displayed on the unit with the error	Yes
xL4	MCE error	Displayed on the unit with the error	Yes
xL5	Zero speed protection	Displayed on the unit with the error	Yes
xL7	Phase sequence error	Displayed on the unit with the error	Yes
xL8	Compressor frequency variation greater than 15Hz within one second protection	Displayed on the unit with the error	Yes
xL9	Actual compressor frequency differs from target frequency by more than 15Hz protection	Displayed on the unit with the error	Yes

Notes:

- 'x' is a placeholder for the compressor system (compressor and related electrical components), with 1 representing compressor system A and 2 representing compressor system B. 'y' is a placeholder for the address (1 or 2) of the slave unit with the error.
- For some error codes, a manual restart is required before the system can resume operation.
- Once the EXV has been connected properly, the error code will flash to indicate that the connection has been re-established. A manual restart is then required before the system can resume operation.

## 2 Troubleshooting

### 2.1 Warning

#### Warning



- All electrical work must be carried out by competent and suitably qualified, certified and accredited professionals and in accordance with all applicable legislation (all national, local and other laws, standards, codes, rules, regulations and other legislation that apply in a given situation).
- Power-off the outdoor units before connecting or disconnecting any connections or wiring, otherwise electric shock (which can cause physical injury or death) may occur or damage to components may occur.

## 2.2 E0: Communication error between outdoor units

### 2.2.1 Digital display output

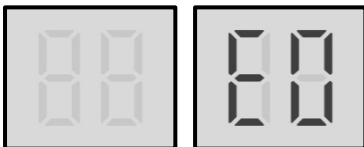

### 2.2.2 Description

- Communication error between outdoor units.
- All units stop running.
- Error code is only displayed on the slave unit with the error.

### 2.2.3 Trigger / recover condition

- Trigger condition: Slave unit cannot receive signal from master unit for 60s.
- Recover condition: Slave unit can receive signal from master unit.
- Reset method: Resume automatically.

### 2.2.4 Possible causes

- Incorrect outdoor unit address setting.
- Communication wires between outdoor units not connected properly.
- Loosened wiring within electric control box.
- Damaged main PCB or electric control box communication terminals block.

## 2.2.5 Procedure

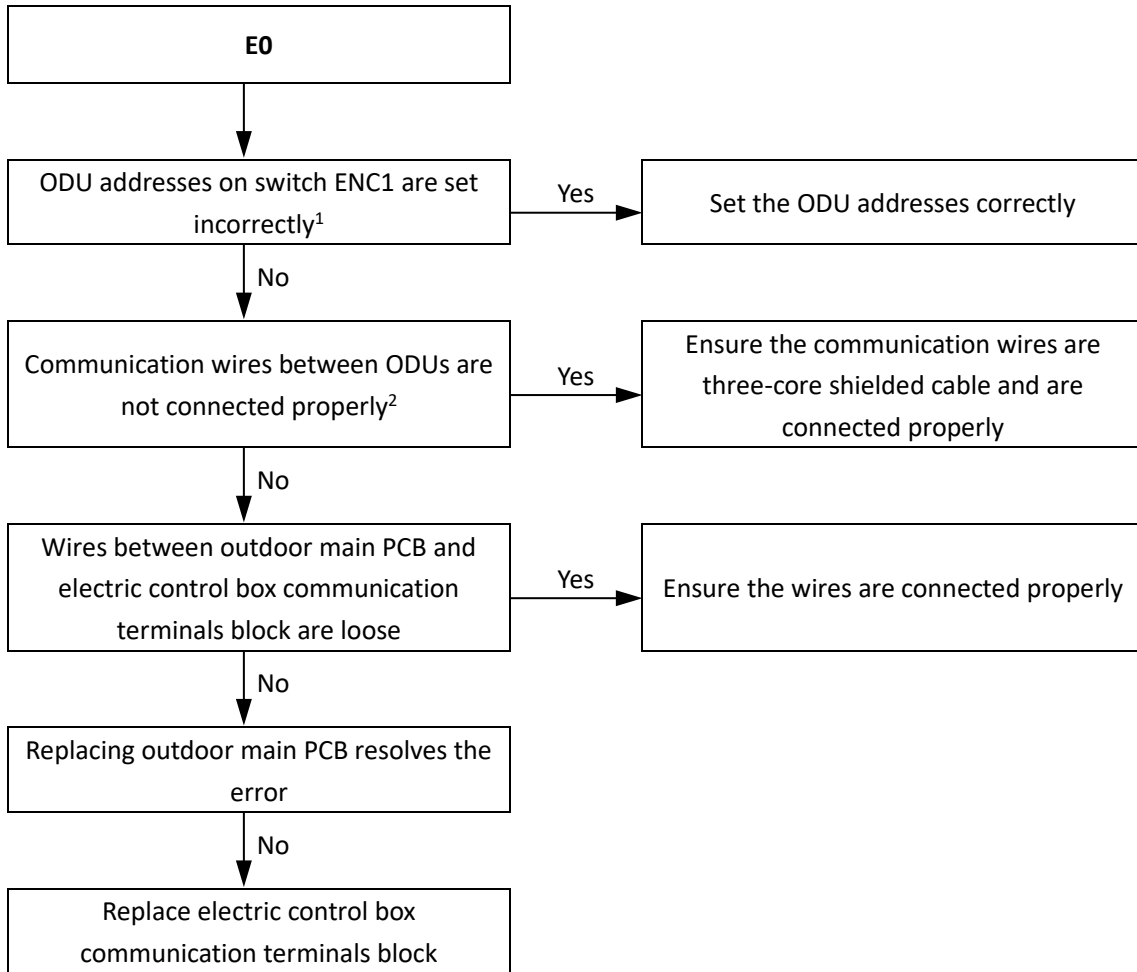

### Notes:

1. The master unit address should be set as 0, slave units addresses should be set from 1 to 3, and the addresses should not be repeated within one system.
2. All the wires for H1, H2, E connections should be three-core shielded cable, the wiring should be connected according to polarity (H1 to H1, etc), and the wiring should not be open or short circuited.

## 2.3 E2: Communication error between indoor and master unit

### 2.3.1 Digital display output

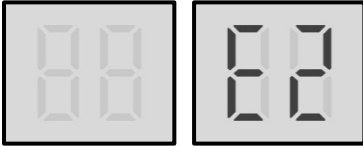

### 2.3.2 Description

- Communication error between indoor and master unit.
- All units stop running.
- Error code is only displayed on the master unit.

### 2.3.3 Trigger / recover condition

- Trigger condition: Indoor units and outdoor units cannot communication for 2 minutes after the system power on 20 minutes.
- Recover condition: Communication go back to normal.
- Reset method: Resume automatically.

### 2.3.4 Possible causes

- Communication wires between indoor and outdoor units not connected properly.
- Indoor unit power supply abnormal.
- Loosened wiring within electric control box.
- Interference from high voltage wires or other sources of electromagnetic radiation.
- Communication wire too long.
- Damaged main PCB or electric control box communication terminals block.

### 2.3.5 Procedure

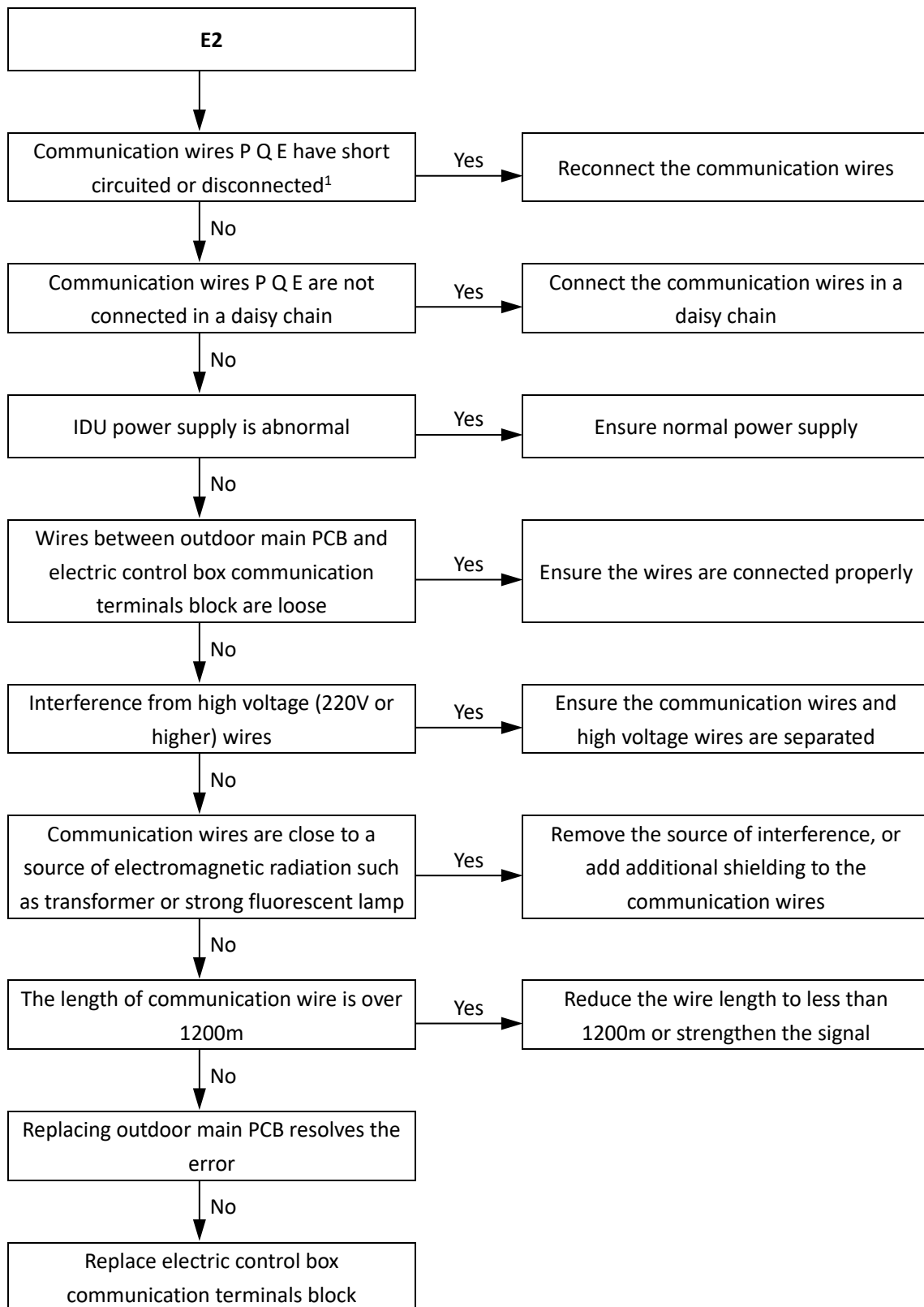

Notes:

1. Measure the resistance among P, Q and E. The normal resistance between P and Q is 120Ω, between P and E is infinite, between Q and E is infinite.

## 2.4 E4: Temperature sensor (T3/T4) error

### 2.4.1 Digital display output

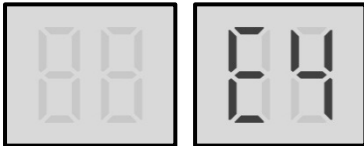

### 2.4.2 Description

- Outdoor heat exchanger temperature sensor (T3) error or outdoor ambient temperature sensor (T4) error.
- All units stop running.
- Error code is only displayed on the unit with the error.

### 2.4.3 Trigger / recover condition

- Trigger condition: The main control board cannot receive the feedback signal of temperature sensor T3 or T4.
- Recover condition: The main control board can receive the feedback signal of temperature sensor T3 or T4.
- Reset method: Resume automatically.

### 2.4.4 Possible causes

- Temperature sensor not connected properly or has malfunctioned.
- Damaged main PCB.

## 2.4.5 Procedure

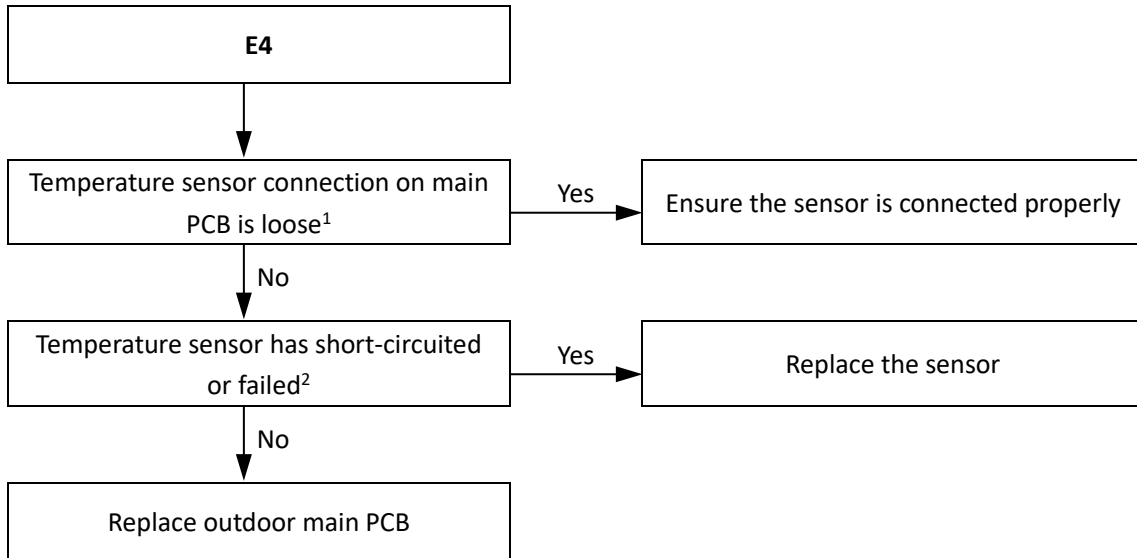

### Notes:

1. Outdoor ambient temperature sensor (T4) and heat exchanger temperature sensor (T3) connection is port CN1 on the main PCB (labeled 11 in Figure 5-2.1 in Part 5, 2.1 "Ports").
2. Measure sensor resistance. If the resistance is too low, the sensor has short-circuited. If the resistance is not consistent with the sensor's resistance characteristics table, the sensor has failed. Refer to Table 6-3.1 in Part 6, 3.1 "Temperature Sensor Resistance Characteristics".

## 2.5 E5: Abnormal power supply voltage

### 2.5.1 Digital display output

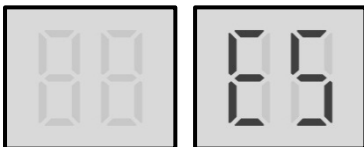

### 2.5.2 Description

- Abnormal power supply voltage.
- All units stop running.
- Error code is only displayed on the unit with the error.

### 2.5.3 Trigger / recover condition

- Trigger condition: Outdoor unit power supply phase voltage < 170V.
- Recover condition: Outdoor unit power supply phase voltage is > 180V.
- Reset method: Resume automatically.

### 2.5.4 Possible causes

- Outdoor unit power supply voltage is abnormal or a phase is missing.
- Loosened wiring within electric control box.
- High voltage circuit error.
- Main PCB damaged.



## 2.5.5 Procedure

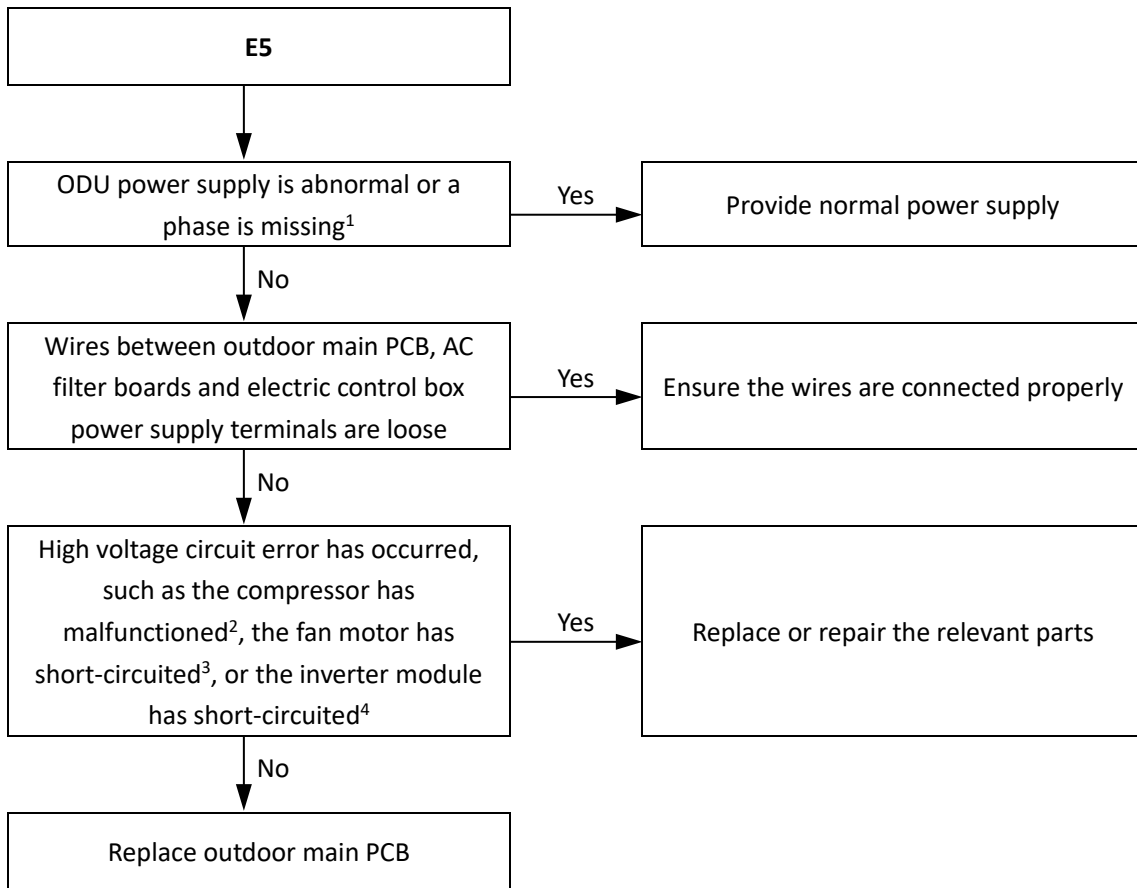

### Notes:

1. The normal voltage between L1 and L2, L1 and L3, and L2 and L3 is 198-242V.
2. The normal resistances of the inverter compressor are 0.05-0.15Ω among U V W and infinite between each of U V W and ground. If any of the resistances differ from these specifications, the compressor has malfunctioned.
3. The normal resistances of the fan motor coil among U V W are less than 10Ω. If a measured resistance is 0Ω, the fan motor has short-circuited.
4. Set a multi-meter to buzzer mode and test any two terminals of P N U V W of the inverter module. If the buzzer sounds, the inverter module has short-circuited.

Figure 6-2.1: Inverter module terminals



## 2.6 E7: Temperature sensor (T7C1/2) error

### 2.6.1 Digital display output

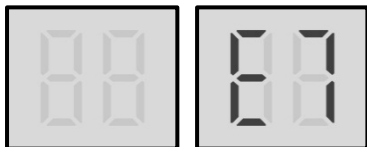

### 2.6.2 Description

- A compressor top temperature sensor or discharge pipe temperature sensor (T7C1/2) error.
- All units stop running.
- Error code is only displayed on the unit with the error.

### 2.6.3 Trigger / recover condition

- Trigger condition: Discharge pressure  $\geq$  3MPa and discharge temperature  $<$  15°C for 2 minutes.
- Recover condition: Discharge pressure and temperature go back to normal.
- Reset method: Manually restart.

### 2.6.4 Possible causes

- Temperature sensor not connected properly or has malfunctioned.
- Damaged main PCB.

## 2.6.5 Procedure

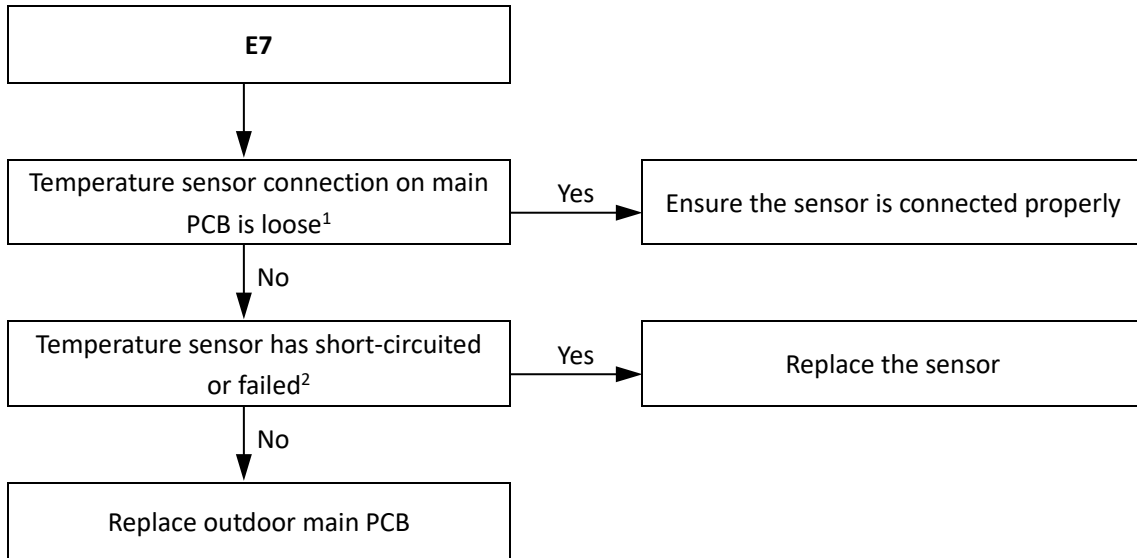

### Notes:

1. Compressor top temperature sensor and discharge pipe temperature sensor connections are ports CN4 and CN5 on the main PCB (labeled 3 and 4, respectively, in Figure 5-2.1 in Part 5, 2.1 "Ports").
2. Measure sensor resistance. If the resistance is too low, the sensor has short-circuited. If the resistance is not consistent with the sensor's resistance characteristics table, the sensor has failed. Refer to Table 6-3.2 in Part 6, 3.1 "Temperature Sensor Resistance Characteristics".

## 2.7 E8: Outdoor unit address error

### 2.7.1 Digital display output

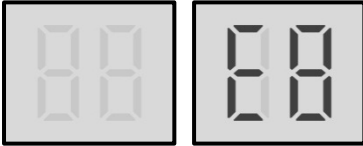

### 2.7.2 Description

- Outdoor unit address error.
- All units stop running.
- Error code is only displayed on the unit with the error.

### 2.7.3 Trigger / recover condition

- Trigger condition: Outdoor unit address is set more than 3.
- Recover condition: Outdoor unit addresses are set from 0 to 3.
- Reset method: Manually restart.

### 2.7.4 Possible causes

- Invalid outdoor unit address.
- Main PCB damaged.

## 2.7.5 Procedure

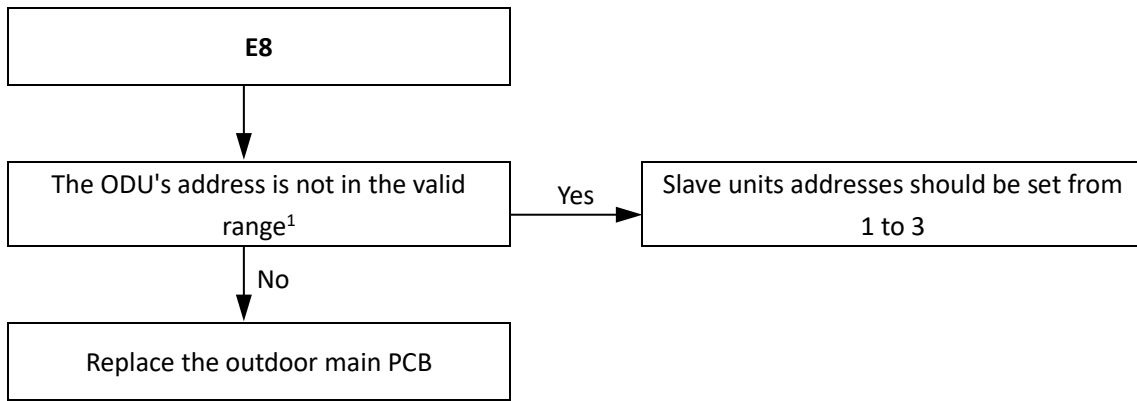

### Notes:

1. The master unit address should be set as 0, slave units addresses should be set from 1 to 3, and the addresses should not be repeated within one system.

## 2.8 xE9: EEPROM mismatch

### 2.8.1 Digital display output

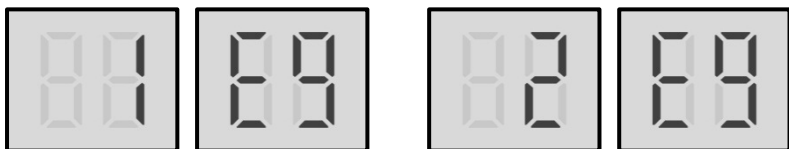

In the error code, 'x' is a placeholder for the compressor system (compressor and related electrical components), with 1 representing compressor system A and 2 representing compressor system B.

### 2.8.2 Description

- 1E9 indicates a compressor A EEPROM mismatch.
- 2E9 indicates a compressor B EEPROM mismatch.
- All units stop running.
- Error code is only displayed on the unit with the error.

### 2.8.3 Trigger / recover condition

- Trigger condition: Compressor drive parameter is mismatch.
- Recover condition: Compressor drive parameter is match.
- Reset method: Manually restart.

### 2.8.4 Possible causes

- Outdoor unit was powered on immediately after being powered off.
- Main PCB damaged.

## 2.8.5 Procedure

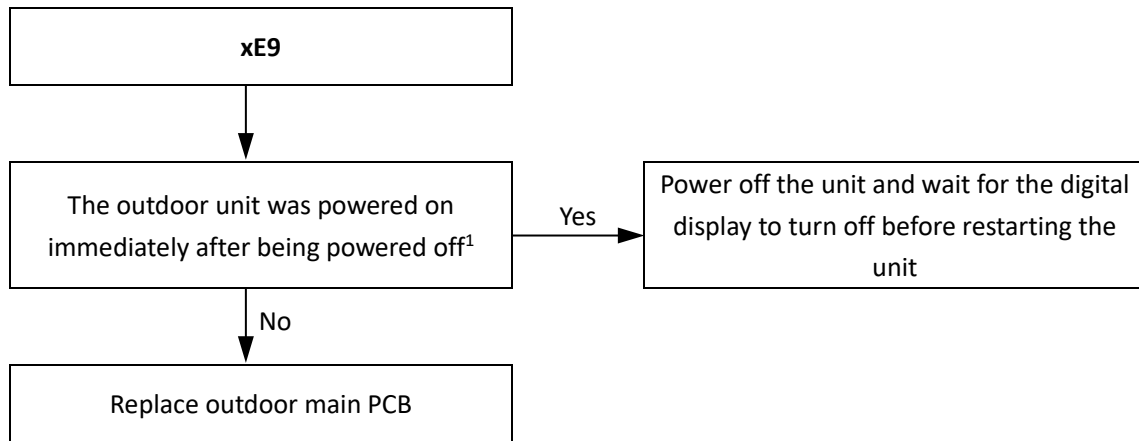

### Notes:

1. When performing a manual restart of an outdoor unit, once the unit has been powered off it should not be powered on again until the digital display has turned off.

## 2.9 xF1: DC bus voltage error

### 2.9.1 Digital display output

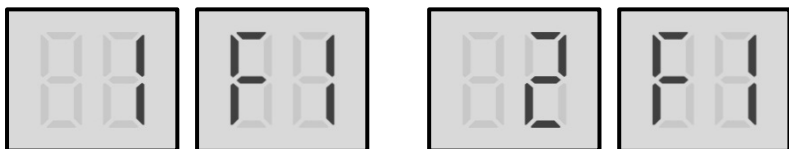

'x' is a placeholder for the compressor system (compressor and related electrical components), with 1 representing compressor system A and 2 representing compressor system B.

### 2.9.2 Description

- 1F1 indicates compressor A DC bus voltage error; 2F1 indicates compressor B DC bus voltage error.
- All units stop running.
- Error code is only displayed on the unit with the error.

### 2.9.3 Trigger / recover condition

- Trigger condition: DC bus voltage < 150V or DC bus voltage >500V continuously for 10 seconds.
- Recover condition: DC bus voltage goes back to normal.
- Reset method: Restart automatically.

### 2.9.4 Possible causes

- Loosened wiring of the compressor inverter module.
- Incorrect wiring of the reactor and DC bus wire.
- Abnormal power supply.
- Inverter module damaged.



## 2.9.5 Procedure

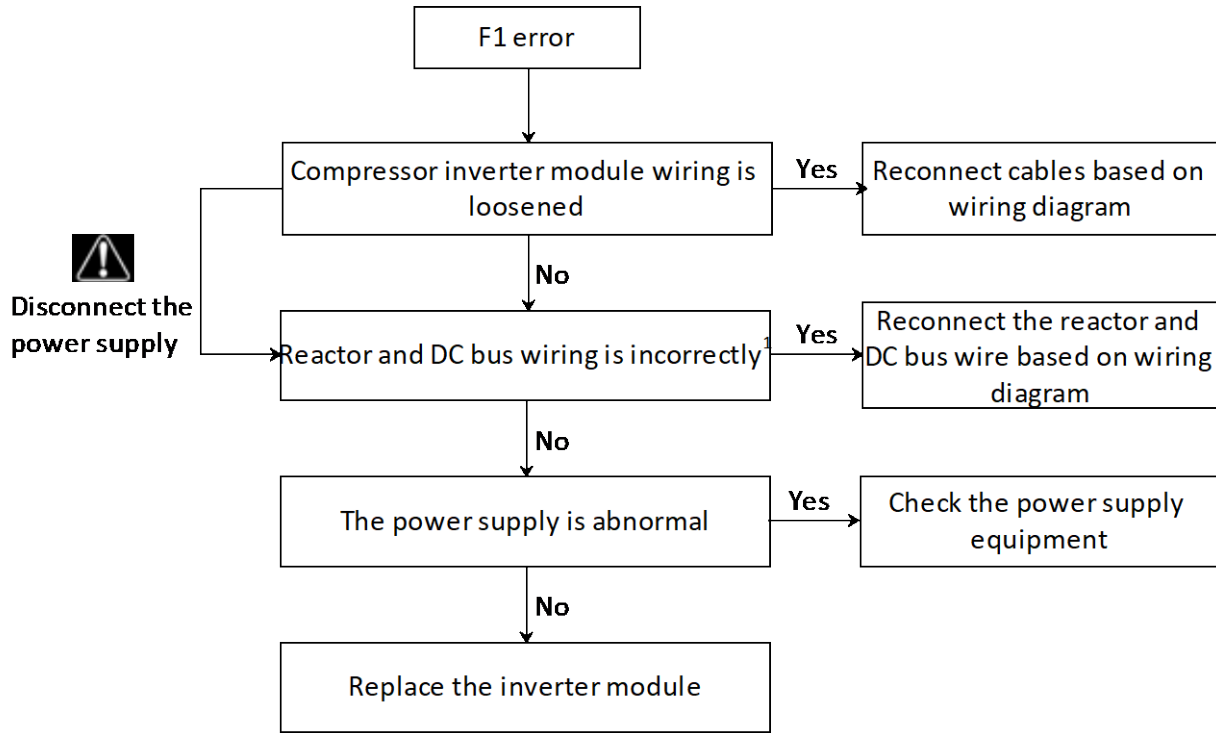

Note:

1. The DC bus wire should run from the N\_in terminal on the inverter module, through the current sensor (in the direction indicated by the arrow on the current sensor), and end at the N\_out terminal on the inverter module.

Figure 6-2.2: DC detection wire connection method

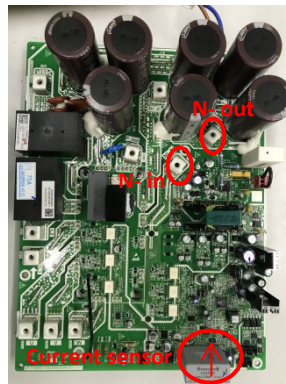

## 2.10 F3, F5: Temperature sensor (T6B/T6A) error

### 2.10.1 Digital display output

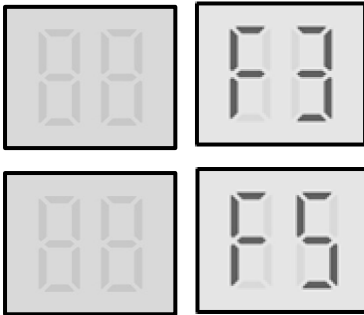

### 2.10.2 Description

- F3 indicates plate heat exchanger cooling refrigerant outlet temperature sensor (T6B) error.
- F5 indicates plate heat exchanger cooling refrigerant inlet temperature sensor (T6A) error.
- All units stop running.
- Error code is only displayed on the unit with the error.

### 2.10.3 Trigger / recover condition

- Trigger condition: Temperature sensor T6A(B) is open or short-circuit.
- Recover condition: Temperature sensor T6A(B) connection ports can detect load.
- Reset method: Resume automatically.

### 2.10.4 Possible causes

- Temperature sensor not connected properly or has malfunctioned.
- Damaged main PCB.

### 2.10.5 Procedure

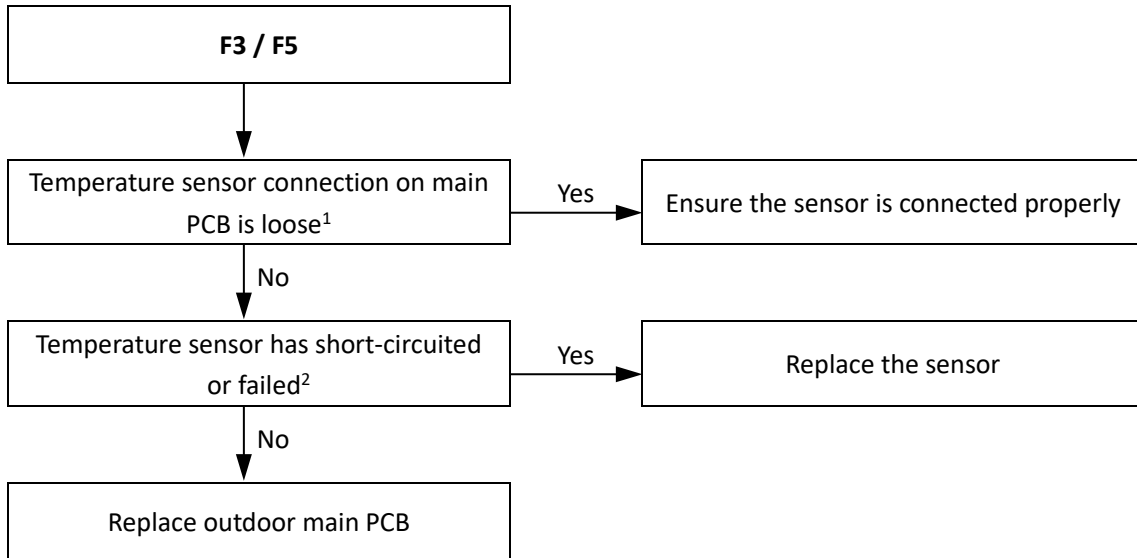

Notes:

1. Plate heat exchanger cooling refrigerant inlet temperature sensor (T6A) and plate heat exchanger cooling refrigerant outlet temperature sensor (T6B) connection are port CN8 and CN8\_1 on the main PCB (labeled 10 and 12, respectively, in Figure 5-2.1 in Part 5, 2.1 "Ports").
2. Measure sensor resistance. If the resistance is too low, the sensor has short-circuited. If the resistance is not consistent with the sensor's resistance characteristics table, the sensor has failed. Refer to Table 6-3.1 in Part 6, 3.1 "Temperature Sensor Resistance Characteristics".

## 2.11 F6: Electronic expansion valve connection error

### 2.11.1 Digital display output

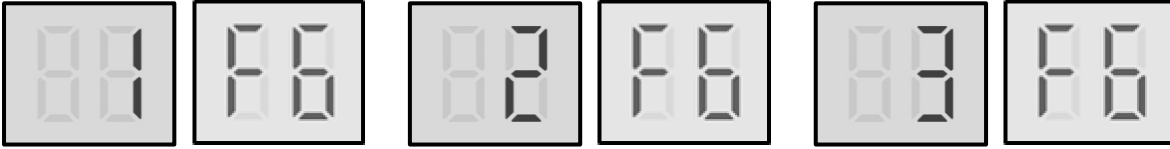

In the error code, 'x' is a placeholder for the EXV system, with 1 representing EXVA, 2 representing EXVB, and 3 representing EXVC.

### 2.11.2 Description

- Electronic expansion valve connection error.
- All units stop running.
- Error code is only displayed on the unit with the error.

### 2.11.3 Trigger / recover condition

- Trigger condition: The main control board cannot receive the feedback signal of EXV.
- Recover condition: The main control board can receive the feedback signal of EXV.
- Reset method: When the main control board can receive the feedback signal of EXV, F6 flashes, a manual system restart is required before the system can resume operation.

### 2.11.4 Possible causes

- Electronic expansion valve coil not connected properly or has malfunctioned.
- Damaged main PCB.

### 2.11.5 Procedure

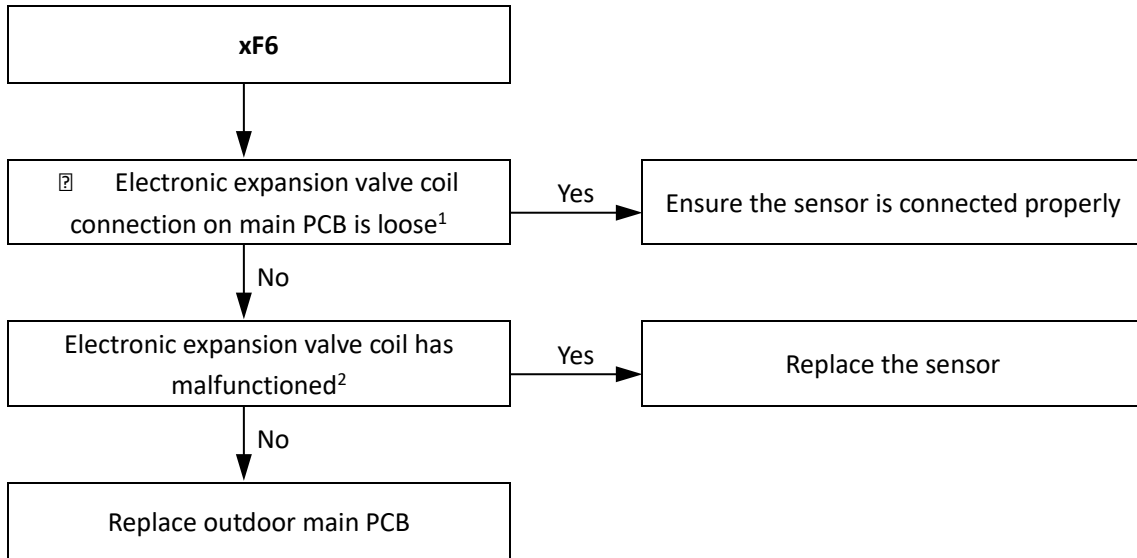

Notes:

1. Electronic expansion valve coil connections are port CN70, CN71 and CN72 on the main PCB (labeled 18, 19 and 20, respectively, in Figure 5-2.1 in Part 5, 2.1 "Ports").
2. The normal resistances between EXV coil wiring terminals RED and white / yellow / orange / blue are 40-50Ω. If any of the resistances differ from the value, the EXV coil has malfunctioned.

Figure 6-2.3: EXV coil wiring terminals

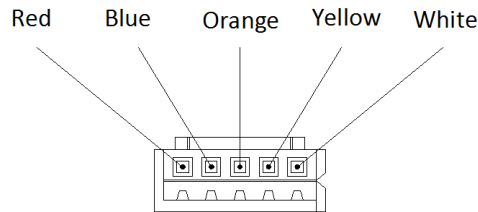

## 2.12 xH0: Communication error

### 2.12.1 Digital display output

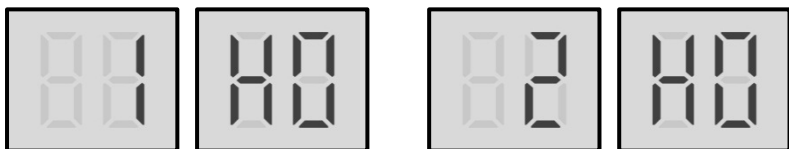

In the error code, 'x' is a placeholder for the compressor system (compressor and related electrical components), with 1 representing compressor system A and 2 representing compressor system B.

### 2.12.2 Description

- 1H0 indicates a communication error between the main control chip and the compressor A inverter driver chip.
- 2H0 indicates a communication error between the main control chip and the compressor B inverter driver chip.
- All units stop running.
- Error code is only displayed on the unit with the error.

### 2.12.3 Trigger / recover condition

- Trigger condition: Main control chip and inverter driver chip cannot communication for 2 minutes.
- Recover condition: Communication go back to normal.
- Reset method: Resume automatically.

### 2.12.4 Possible causes

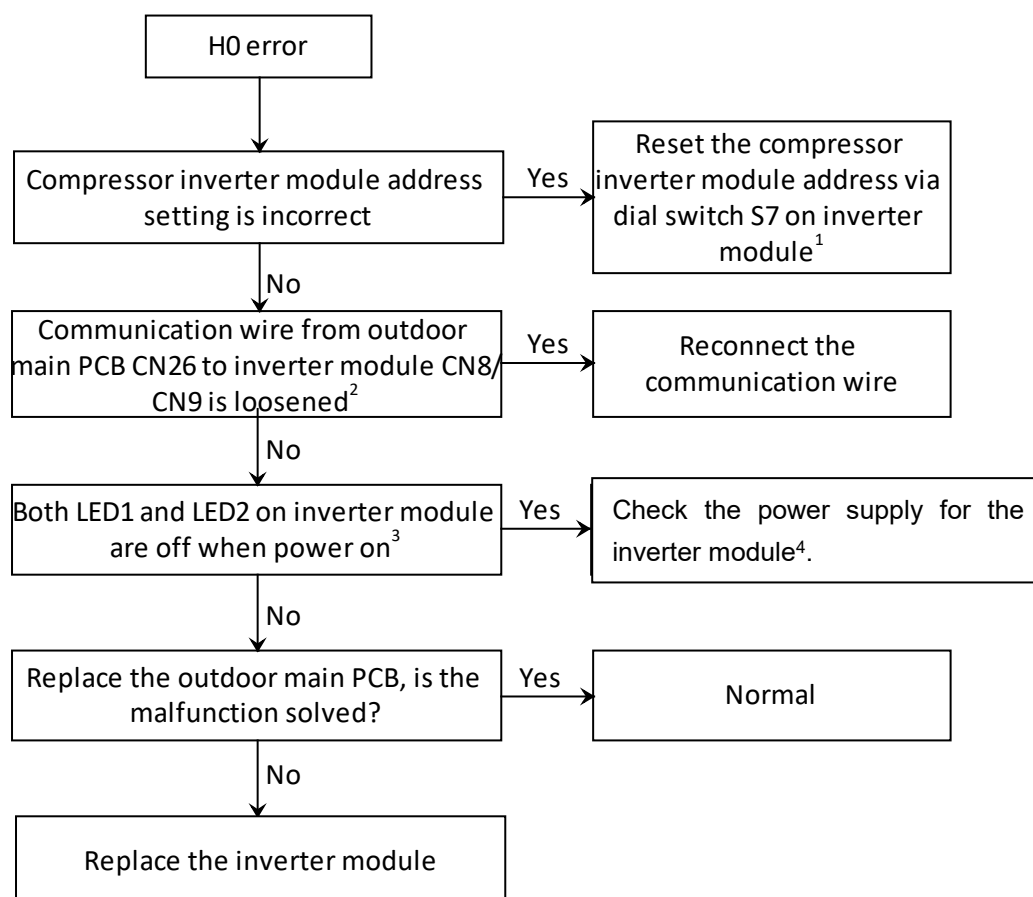

- Incorrect compressor inverter module address setting.
- Main PCB damaged.
- Loosened communication wiring from the main PCB to the inverter module.
- Compressor inverter module damaged.

### 2.12.5 Procedure



Notes:

- Compressor inverter module address is set through dial switch S7 on the inverter module. The compressor inverter module A/B location refers to the wiring diagram.

S7 on inverter module	Inverter module address
 ON 1 2	0 for compressor inverter module A
 ON 1 2	1 for compressor inverter module B

- Communication wire from outdoor main PCB CN26 to inverter module CN8/CN9.

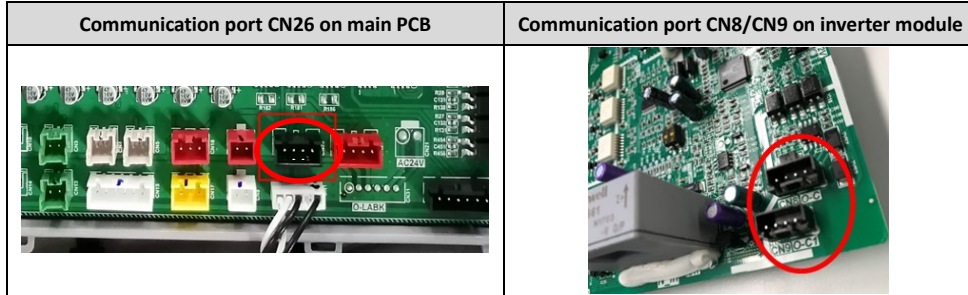

- LED1/2 on inverter module

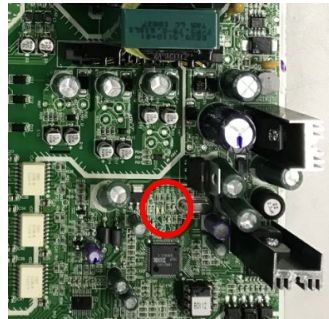

- Check the power supply for the compressor inverter module, the normal voltage between CN6( L1) and CN7( L2), L1(CN6) and L3(CN11), and L2(CN7) and L3(CN11) is 198-242V.

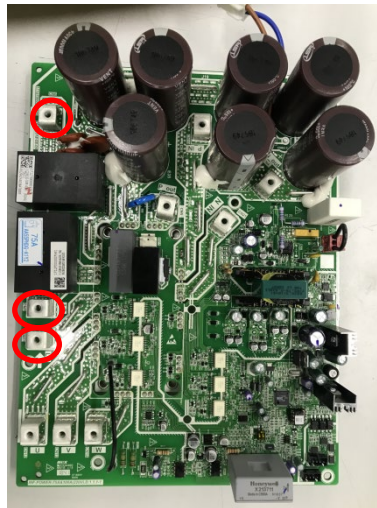

## 2.13 H2, H3: Slave units decreased/increased

### 2.13.1 Digital display output

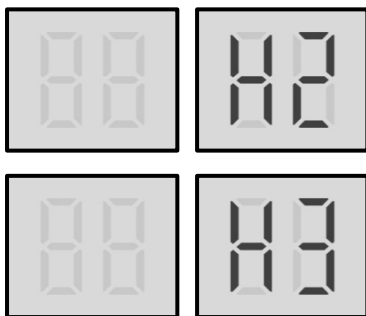

### 2.13.2 Description

- H2 indicates that the number of slave units detected by master unit has decreased.
- H3 indicates that the number of slave units detected by master unit has increased.
- All units stop running.
- Error code is only displayed on the master unit.

### 2.13.3 Trigger / recover condition

- Trigger condition: Number of slave units detected by master unit has decreased or increased.
- Recover condition: Number of slave units detected by master unit goes back to normal.
- Reset method: Resume automatically.

### 2.13.4 Possible causes

- Some outdoor units are powered off.
- Power supply abnormal.
- Incorrect outdoor unit address setting.
- Communication wires between outdoor units not connected properly.
- Loosened wiring within electric control box.
- Damaged main PCB or electric control box communication terminals block.



### 2.13.5 Procedure

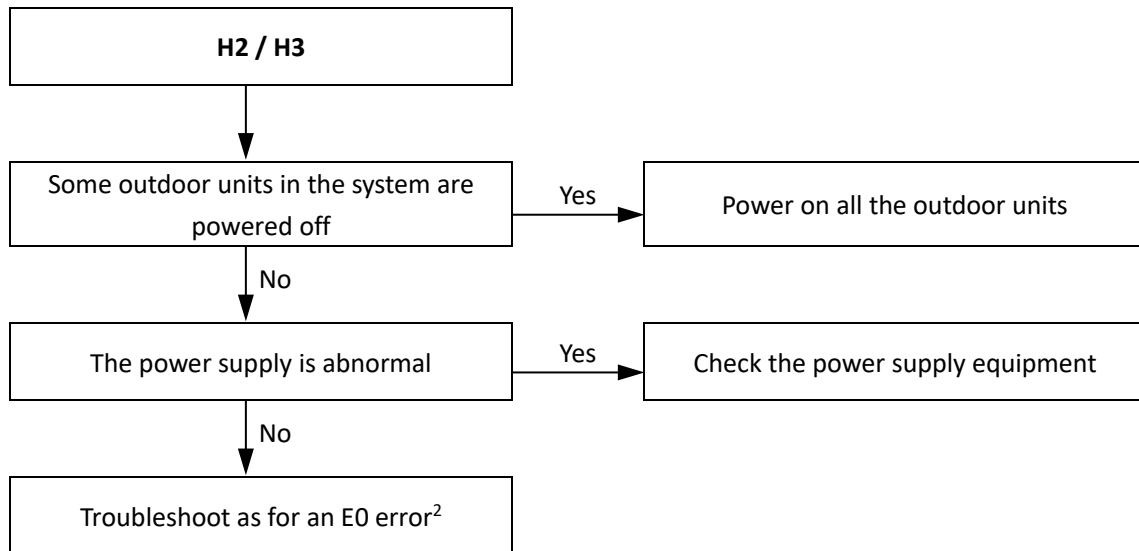

Notes:

1. See "E0 Troubleshooting".

## 2.14 xH4: Inverter module protection

### 2.14.1 Digital display output

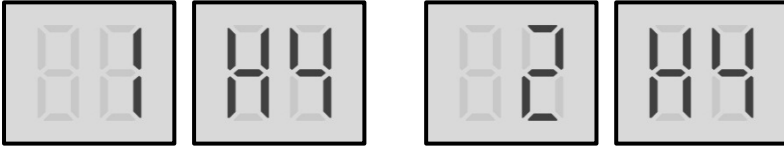

In the error code, 'x' is a placeholder for the compressor system (compressor and related electrical components), with 1 representing compressor system A and 2 representing compressor system B.

### 2.14.2 Description

- 1H4 indicates compressor A inverter module protection.
- 2H4 indicates compressor B inverter module protection.
- All units stop running.
- Error code is only displayed on the unit with the error.

### 2.14.3 Trigger / recover condition

- Trigger condition: Compressor appears three inverter module protections.
- Recover condition: Inverter module goes back to normal.
- Reset method: Manually restart.

### 2.14.4 Possible causes

- Inverter module protection.
- DC bus low or high voltage protection.
- MCE error.
- Zero speed protection.
- Phase sequence error.
- Excessive compressor frequency variation.
- Actual compressor frequency differs from target frequency.

### 2.14.5 Specific error codes for xH4 inverter module protection

If an xH4 error code is displayed, enter menu mode “n31” (refer to Part 5, 2.2.3 “menu mode”) to check the history error code to check the following specific error code: xL0, xL1, xL2, xL4, xL5, xL7, xL8, xL9.

Table 6-2.1: Specific error codes for error xH4

Specific error code <sup>1</sup>	Content
xL0	Inverter module protection
xL1	DC bus low voltage protection
xL2	DC bus high voltage protection
xL4	MCE error
xL5	Zero speed protection
xL7	Phase sequence error
xL8	Compressor frequency variation be equal to or greater than 15Hz within one second protection
xL9	Actual compressor frequency differs from target frequency by be equal to or greater than 15Hz protection

Notes:

1. 'x' is a placeholder for the compressor system (compressor and related electrical components), with 1 representing compressor system A and 2 representing compressor system B.

The specific error codes xL0, xL1, xL2 and xL4 can also be obtained from the inverter module LED indicators. If an inverter module error has occurred, LED2 is continuously on and LED1 flashes.

Figure 6-2.4: LED indicators LED1 and LED2 on inverter module

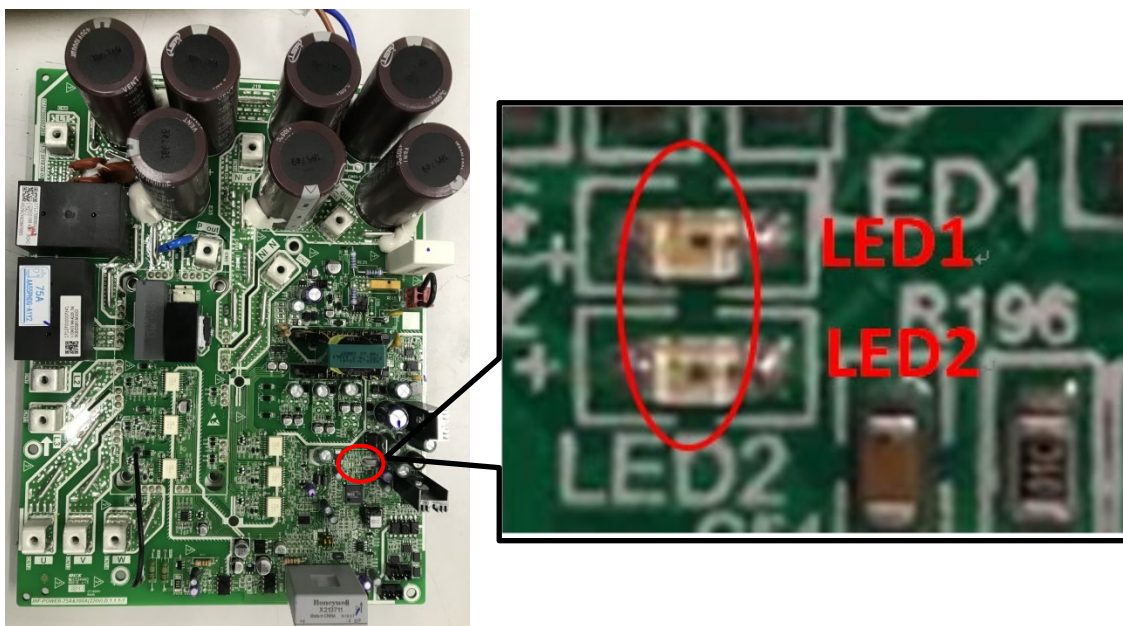
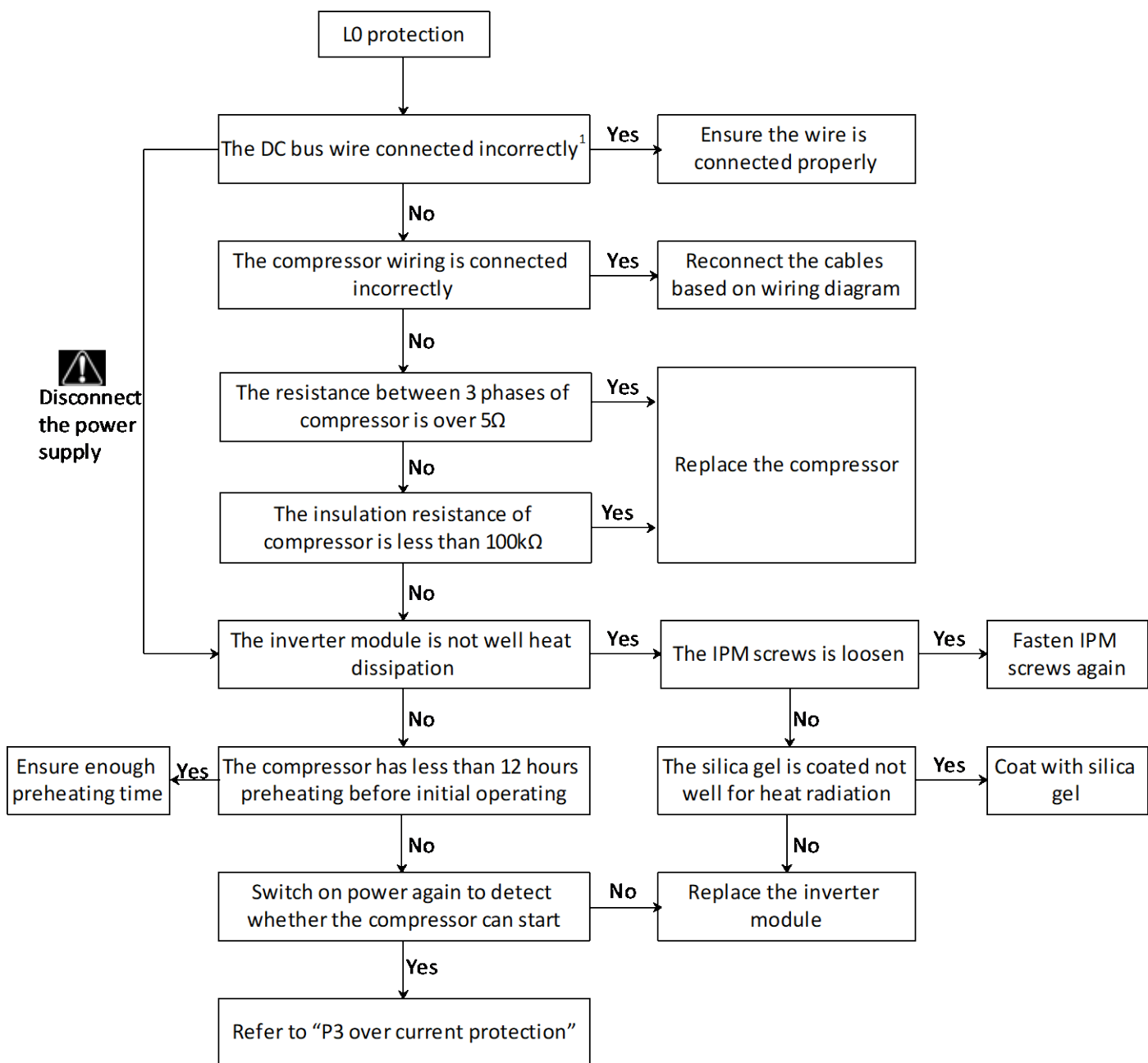

Table 5-3.2: Errors indicated on LED1

LED1 flashing pattern	Corresponding error
Flashes 8 times and stops for 1 second, then repeats	xL0 - Inverter module protection
Flashes 9 times and stops for 1 second, then repeats	xL1 - DC bus low voltage protection
Flashes 10 times and stops for 1 second, then repeats	xL2 - DC bus high voltage protection
Flashes 12 times and stops for 1 second, then repeats	xL4 - MCE error

### 2.14.6 L0: Inverter module protection



- Note:
- The DC bus wire should run from the N\_in terminal on the inverter module, through the current sensor (in the direction indicated by the arrow on the current sensor), and end at the N\_out terminal on the inverter module.

Figure 6-2.5: DC detection wire connection method



### 2.14.7 L1: DC bus low voltage protection

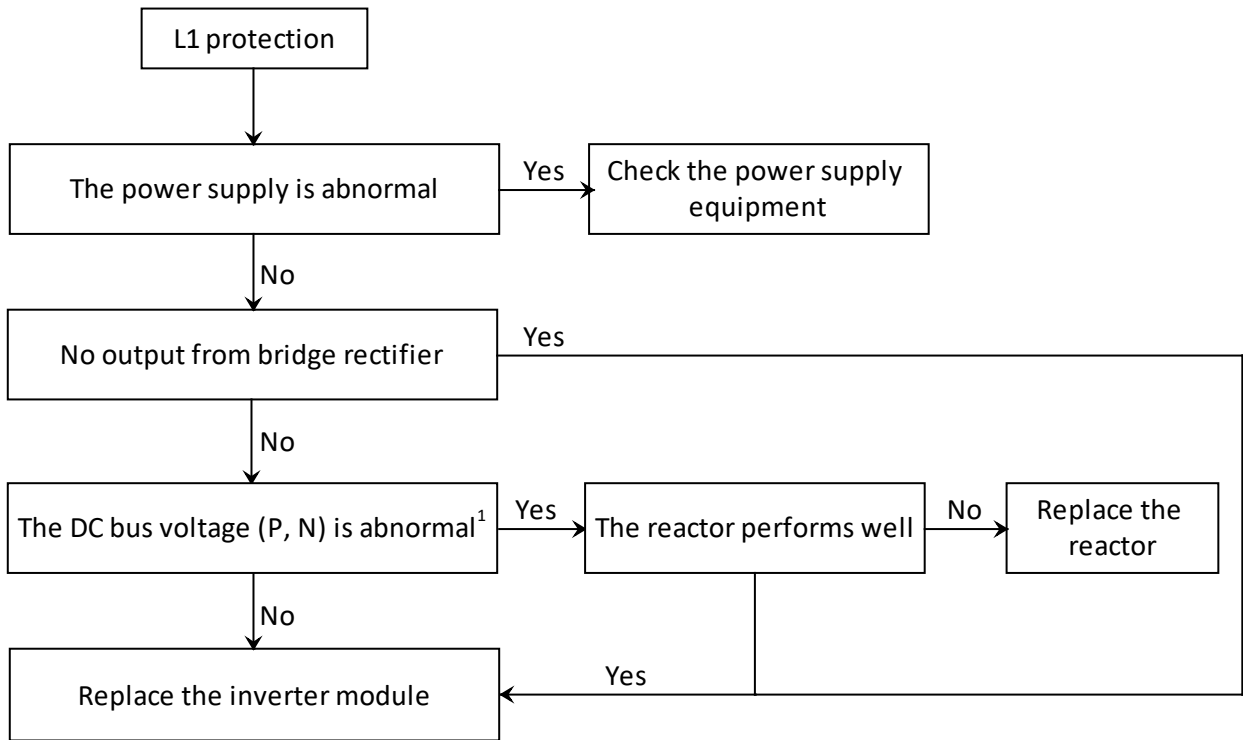

Note:

1. The normal DC voltage between terminals P and N on inverter module should be 240-375V. When the voltage is lower than 150V, L1 protection will be appeared.

Figure 6-2.6: Inverter module terminals



### 2.14.8 L2: DC bus high voltage protection

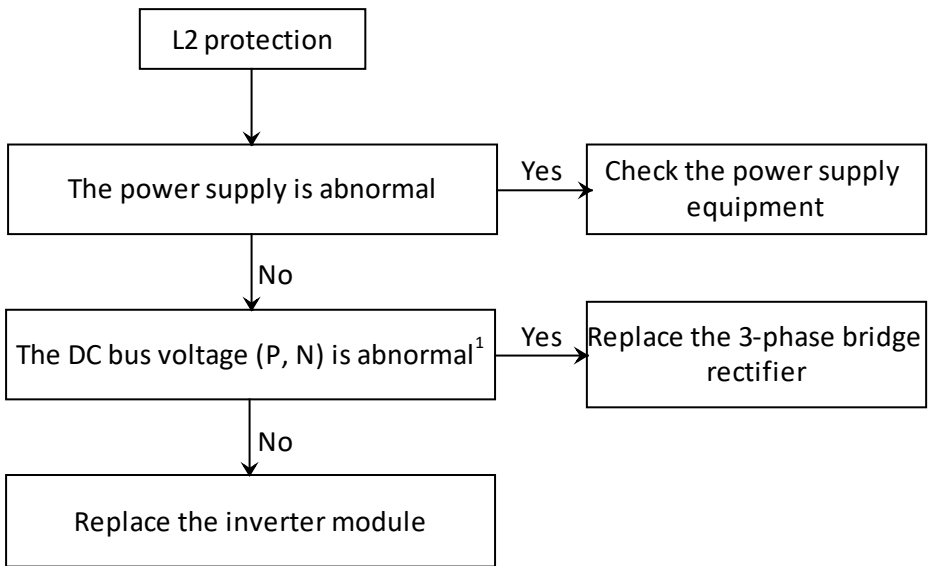

Note:

1. The normal DC voltage between terminals P and N on inverter module should be 240-375V. When the voltage is higher than 500V, L2 protection will be appeared.

Figure 6-2.7: Inverter module terminals



2.14.9 L4: MCE error



Disconnect the power supply

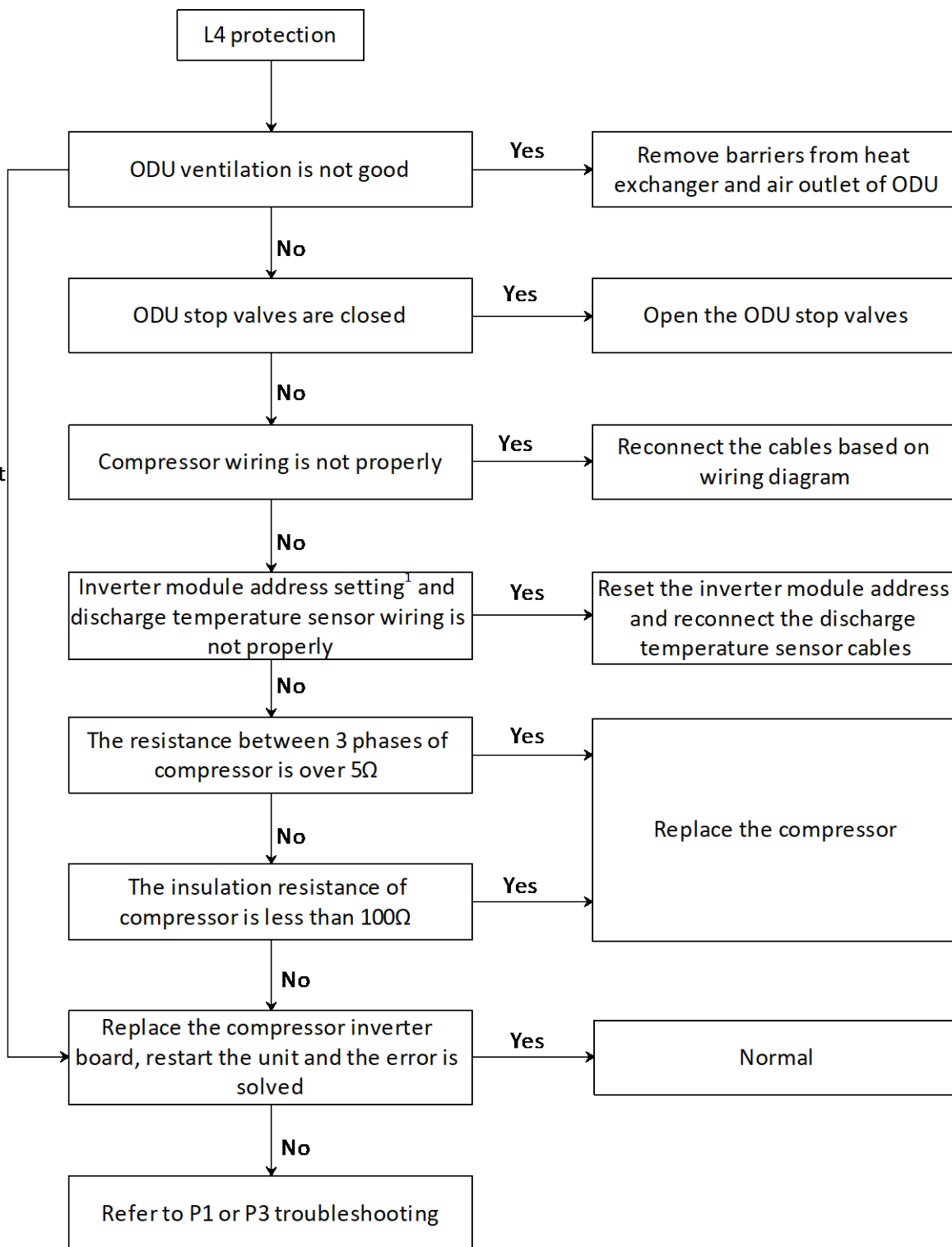

- Notes:
1. Compressor inverter module address is set through dial switch S7 on the inverter module. The compressor inverter module A/B location refers to the wiring diagram.

S7 on inverter module	Inverter module address
	0 for compressor inverter module A
	1 for compressor inverter module B

### 2.14.10 L7: Phase sequence error

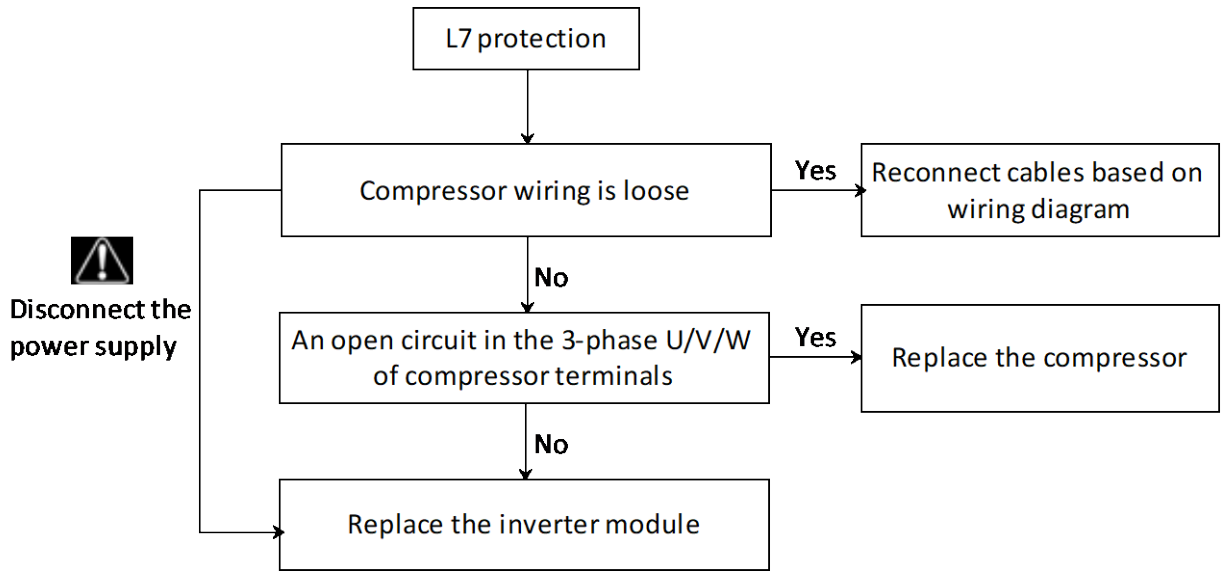



2.14.11 L8: Compressor frequency variation greater than 15Hz within one second protection

L9: Actual compressor frequency differs from target frequency by more than 15Hz protection

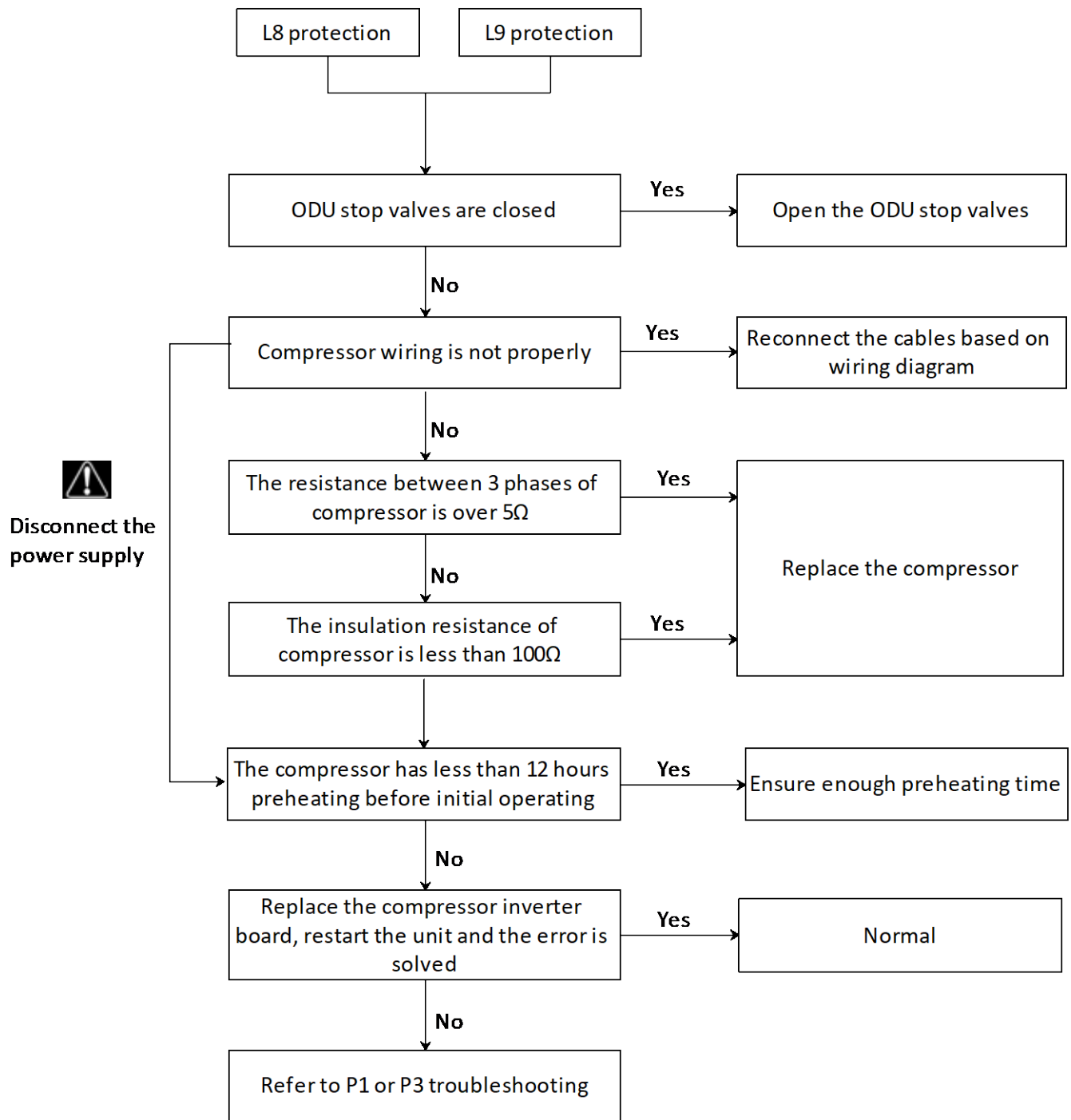

### 2.14.12 Compressor replacement procedure

#### Step 1: Remove faulty compressor and remove oil

- Remove the faulty compressor from the outdoor unit.
- Before removing the oil, shake the compressor so as to not allow impurities to remain settled at the bottom.
- Drain the oil out of the compressor and retain it for inspection. Normally the oil can be drained out from the compressor discharge pipe.

Figure 6-2.8: Draining oil from a compressor



#### Step 2: Inspect oil from faulty compressor

- The oil should be clear and transparent. Slightly yellow oil is not an indication of any problems. However, if the oil is dark, black or contains impurities, the system has problems and the oil needs to be changed. Refer to Figure 5-4.16 for further details regarding inspecting compressor oil. (If the compressor oil has been spoiled, the compressor will not be being lubricated effectively. The scroll plate, crankshaft and bearings will wear. Abrasion will lead to a larger load and higher current. More electric energy will get dissipated as heat and the temperature of the motor will become increasingly high. Finally, compressor damage or burnout will result.)

#### Step 3: Check oil in other compressors in the system

- If the oil drained from the faulty compressor is clean, go to Step 6.
- If the oil drained from the faulty compressor is only lightly spoiled, go to Step 4.
- If the oil drained from the faulty compressor is heavily spoiled, check the oil in the other compressors in the system. Drain the oil from any compressors where the oil has been spoiled. Go to Step 4.

#### Step 4: Replace oil separator(s) and accumulator(s)

- If the oil from a compressor is spoiled (lightly or heavily), drain the oil from the oil separator and accumulator in that unit and then replace them.

#### Step 5: Check filters(s)

- If the oil from a compressor is spoiled (lightly or heavily), check the filter between the gas stop valve and the 4-way valve in that unit. If it is blocked, clean with nitrogen or replace.

#### Step 6: Replace the faulty compressor and re-fit the other compressors

- Replace the faulty compressor.
- If the oil had been spoiled and was drained from the non-faulty compressors in Step 3, use clean oil to clean them before re-fitting them into the units. To clean, add oil into the compressor through the discharge pipe using a funnel, shake the compressor, and then drain the oil. Repeat several times and then re-fit the compressors into the units. (The discharge pipe is connected to the oil pool of the compressor by the inner oil balance pipe.)

Figure 6-2.9: Compressor piping

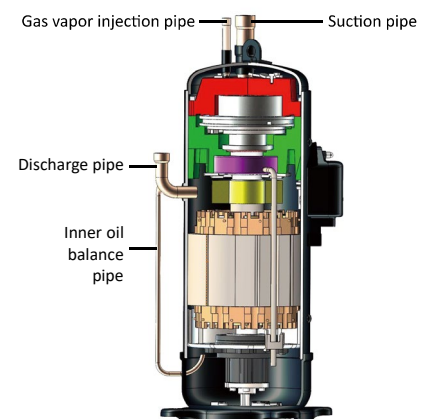

#### Step 7: Add compressor oil

- Add 1.1L of oil to each of the compressors from which oil was drained in Step 3.
- Only use FV68H oil. Different compressors require different types of oil. Using the wrong type of oil leads to various problems.
- Add additional oil to the accumulators such that the total amount of oil is 5L in 8-12HP units, 6L in 14-16HP units 7L in 18-22HP units, 9L in 24-28HP units and 10L in 30-32HP units.

**Step 8: Vacuum drying and refrigerant charging**

- Once all the compressors and other components have been fully connected, vacuum dry the system and recharge refrigerant. Refer to the V6 Engineering Data Book, Part 3.

Figure 6-2.10: Inspecting compressor oil

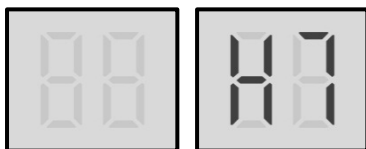

Figure 6-2.11: Effects of spoiled compressor oil



## 2.15 H7: Unmatched total number of indoor units

### 2.15.1 Digital display output



### 2.15.2 Description

- Number of indoor units detected by master unit not same as number set on main PCB.
- All units stop running.
- Error code is only displayed on the master unit.

### 2.15.3 Trigger / recover condition

- Trigger condition: Only one indoor unit cannot be detected by master unit for 8 hours or more than one indoor unit cannot be detected by master unit for 3 minutes.
- Recover condition: Number of indoor units detected by master unit is same as number set on main PCB.
- Reset method: Resume automatically.

### 2.15.4 Possible causes

- Number of indoor units set on main PCB not same as actual number of indoor units.
- Some indoor units are powered off.
- Communication wires between indoor and outdoor units not connected properly.
- Indoor unit PCB damaged.
- Indoor unit without address or indoor unit address duplicated.
- Main PCB damaged.

## 2.15.5 Procedure

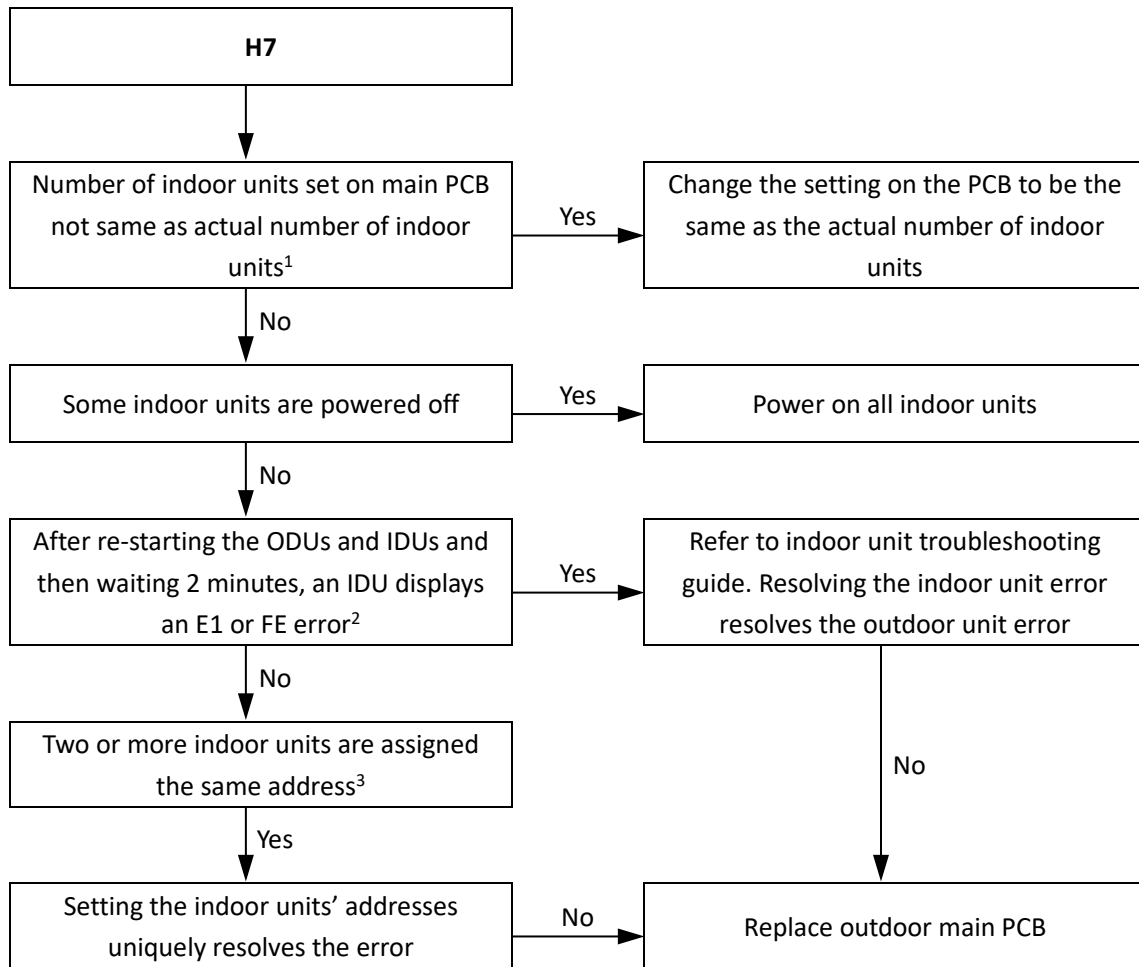

### Notes:

1. The number of indoor units can be set on switches EN3 and S12 on the main PCB.
2. Indoor unit error code E1 indicates a communication error between indoor and master unit. Indoor unit error code FE indicates that an indoor unit has not been assigned an address.
3. Indoor unit addresses can be checked and manually assigned using indoor unit remote/wired controllers. Alternatively, indoor unit addresses can be automatically assigned by the master outdoor unit.

## 2.16 H8: High pressure sensor error

### 2.16.1 Digital display output

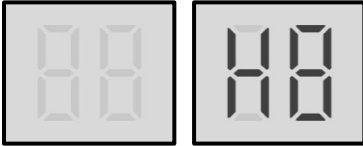

### 2.16.2 Description

- High pressure sensor error.
- All units stop running.
- Error code is only displayed on the unit with the error.

### 2.16.3 Trigger / recover condition

- Trigger condition: Discharge pressure  $\leq$  0.3MPa.
- Recover condition: Discharge pressure  $>$  0.3MPa.
- Reset method: Resume automatically.

### 2.16.4 Possible causes

- Pressure sensor not connected properly or has malfunctioned.
- Insufficient refrigerant.
- Low pressure side blockage.
- Poor evaporator heat exchange.
- Main PCB damaged.

## 2.16.5 Procedure

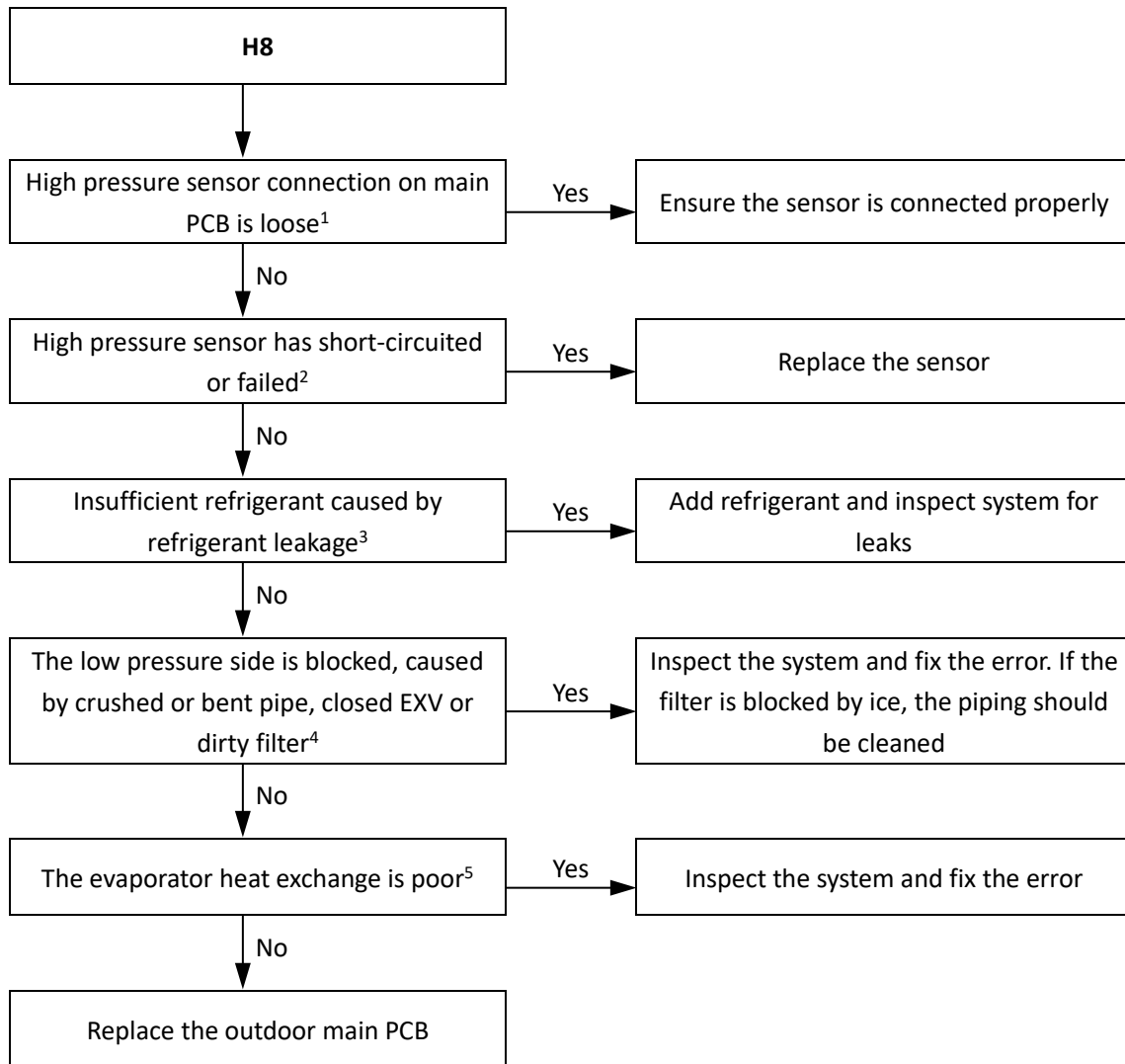

### Notes:

1. High pressure sensor connection is port CN17 on the main PCB (labeled 7 in Figure 5-2.1 in Part 5, 2.1 "Ports").
2. Measure the resistance among the three terminals of the pressure sensor. If the resistance is of the order of mega Ohms or infinite, the pressure sensor has failed.
3. An insufficiency of refrigerant causes compressor discharge temperature to be higher than normal, discharge and suction pressures to be lower than normal and compressor current to be lower than normal, and may cause frosting to occur on the suction pipe. These issues disappear once sufficient refrigerant has been charged into the system. For normal system parameters refer to Table 6-3.4 and 6-3.5 in Part 6, 3.2 "Normal Operating Parameters of Refrigerant System".
4. A low pressure side blockage causes compressor discharge temperature to be higher than normal, suction pressure to be lower than normal and compressor current to be lower than normal, and may cause frosting to occur on the suction pipe. For normal system parameters refer to Table 6-3.4 and 6-3.5 in Part 6, 3.2 "Normal Operating Parameters of Refrigerant System".
5. In cooling mode check indoor heat exchangers, fans and air outlets for dirt/blockages. In heating mode check outdoor heat exchangers, fans and air outlets for dirt/blockages.



## 2.17 yHd: Slave unit malfunction

### 2.17.1 Digital display output

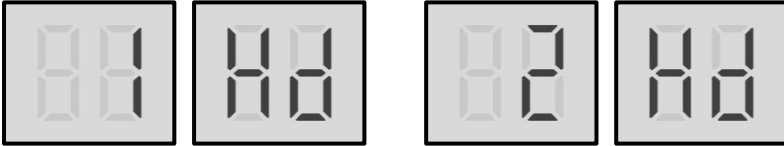

In the error code, 'y' is a placeholder for the address (1 or 2) of the slave unit with the error.

### 2.17.2 Description

- 1Hd indicates an error on the slave unit with address 1.
- 2Hd indicates an error on the slave unit with address 2.
- All units stop running.
- Error code is only displayed on the master unit.

### 2.17.3 Trigger / recover condition

- Trigger condition: Slave unit is malfunction.
- Recover condition: Slave unit goes back to normal.
- Reset method: Resume automatically.

### 2.17.4 Possible causes

- Slave unit malfunction.

### 2.17.5 Procedure

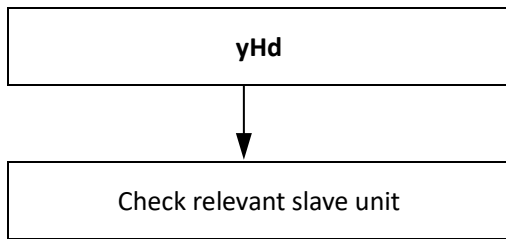

## 2.18 P1: Discharge pipe high pressure protection

### 2.18.1 Digital display output

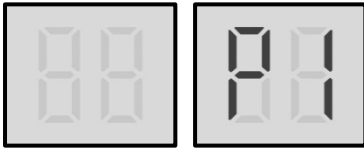

### 2.18.2 Description

- Discharge pipe high pressure protection. If the system has a 3-phase protector and the 3-phase protector is connected with the high pressure switch, the system will display P1 protection when initially powered on, and P1 protection will disappear once the system reaches a steady state.
- All units stop running.
- Error code is only displayed on the unit with the error.

### 2.18.3 Trigger / recover condition

- Trigger condition: Discharge pressure  $\geq 4.4$ MPa.
- Recover condition: Discharge pressure  $\leq 3.2$ MPa.
- Reset method: Resume automatically.

### 2.18.4 Possible causes

- Outdoor unit stop valves are closed.
- Pressure sensor/switch not connected properly or has malfunctioned.
- Excess refrigerant.
- System contains air or nitrogen.
- High pressure side blockage.
- Poor condenser heat exchange.
- Main PCB damaged.

### 2.18.5 Procedure

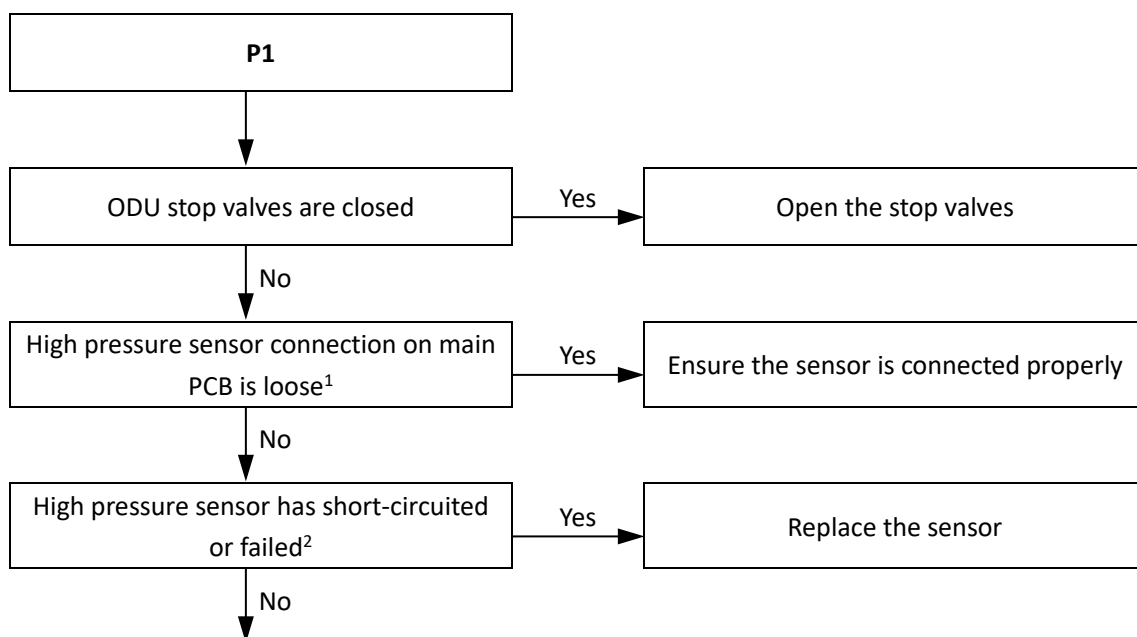

*Flowchart continued on next page ...*

... flowchart continued from previous page

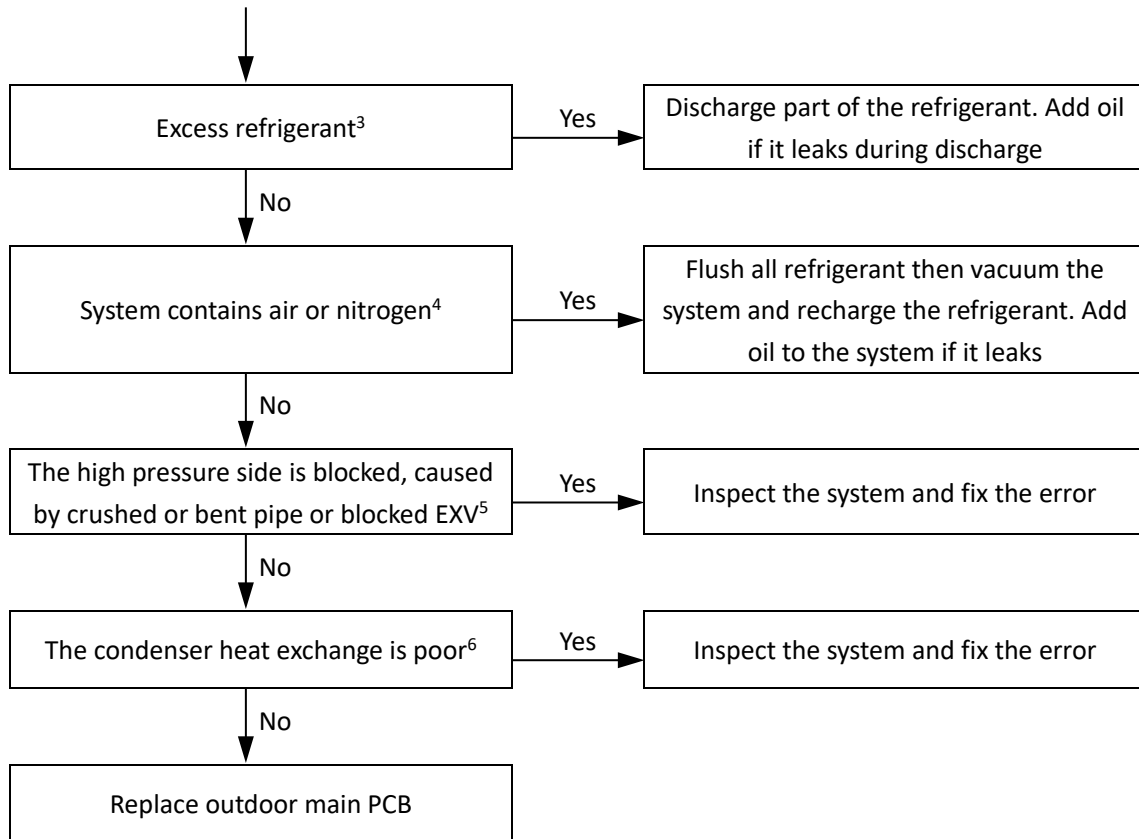

Notes:

1. The high pressure sensor connection is port CN17 on the main PCB (labeled 7 in Figure 5-2.1 in Part 5, 2.1 "Ports").
2. Measure the resistance among the three terminals of the pressure sensor. If the resistance is of the order of mega Ohms or infinite, the pressure sensor has failed.
3. Excess refrigerant causes discharge temperature to be lower than normal, discharge pressure to be higher than normal and suction pressure to be higher than normal. For normal system parameters refer to Table 6-3.4 and 6-3.5 in Part 6, 3.2 "Normal Operating Parameters of Refrigerant System".
4. Air or nitrogen in the system causes discharge temperature to be higher than normal, discharge pressure to be higher than normal, compressor current to be higher than normal, abnormal compressor noise and an unsteady pressure meter reading. For normal system parameters refer to Table 6-3.4 and 6-3.5 in Part 6, 3.2 "Normal Operating Parameters of Refrigerant System".
5. High pressure side blockage causes discharge temperature to be higher than normal, discharge pressure to be higher than normal and suction pressure to be lower than normal. For normal system parameters refer to Table 6-3.4 and 6-3.5 in Part 6, 3.2 "Normal Operating Parameters of Refrigerant System".
6. In cooling mode check outdoor heat exchangers, fans and air outlets for dirt/blockages. In heating mode check indoor heat exchangers, fans and air outlets for dirt/blockages.

## 2.19 P2, H5: Suction pipe low pressure protection

### 2.19.1 Digital display output

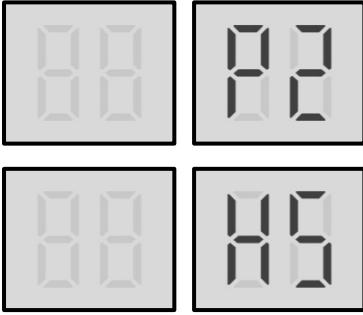

### 2.19.2 Description

- Suction pipe low pressure protection. If the system has a 3-phase protector and the 3-phase protector is connected to the low pressure switch, the system will display P2 protection when initially powered on, and P2 protection will disappear once the system reaches a steady state.
- All units stop running.
- Error code is only displayed on the unit with the error.

### 2.19.3 Trigger / recover condition

- Trigger condition:
  - For P2 protection: Suction pressure  $\leq 0.05\text{MPa}$ .
  - For H5 protection: P2 protection appears three times in 60 minutes.
- Recover condition: Suction pressure  $\geq 0.15\text{MPa}$ .
- Reset method:
  - For P2 protection: Resume automatically.
  - For H5 protection: Manually restart.

### 2.19.4 Possible causes

- Outdoor unit stop valves are closed.
- Insufficient refrigerant.
- Low pressure side blockage.
- Poor evaporator heat exchange.
- Main PCB damaged.

## 2.19.5 Procedure

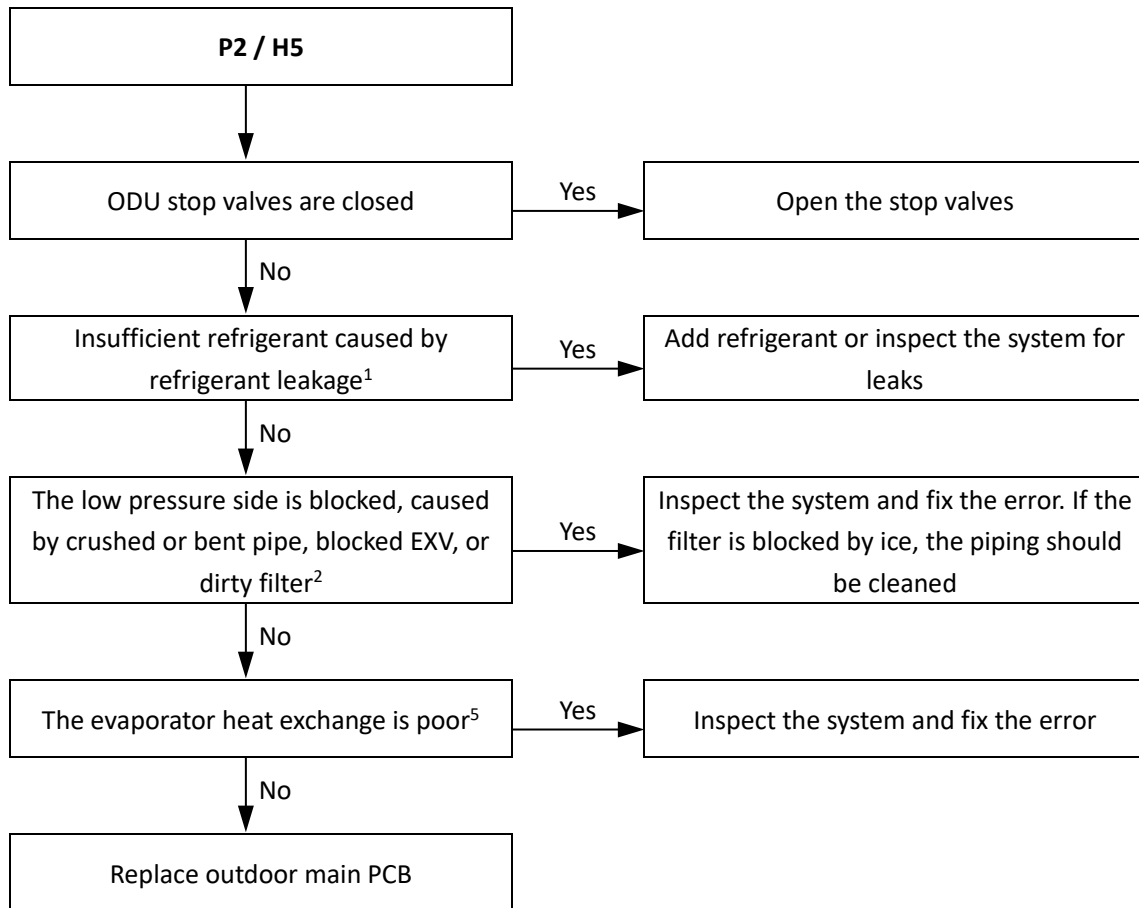

### Notes: ☐

1. An insufficiency of refrigerant causes compressor discharge temperature to be higher than normal, discharge and suction pressures to be lower than normal and compressor current to be lower than normal, and may cause frosting to occur on the suction pipe. These issues disappear once sufficient refrigerant has been charged into the system. For normal system parameters refer to Table 6-3.4 and 6-3.5 in Part 6, 3.2 "Normal Operating Parameters of Refrigerant System".
2. A low pressure side blockage causes compressor discharge temperature to be higher than normal, suction pressure to be lower than normal and compressor current to be lower than normal, and may cause frosting to occur on the suction pipe. For normal system parameters refer to Table 6-3.4 and 6-3.5 in Part 6, 3.2 "Normal Operating Parameters of Refrigerant System".
3. In cooling mode check indoor heat exchangers, fans and air outlets for dirt/blockages. In heating mode check outdoor heat exchangers, fans and air outlets for dirt/blockages.

## 2.20 xP3: Compressor current protection

### 2.20.1 Digital display output

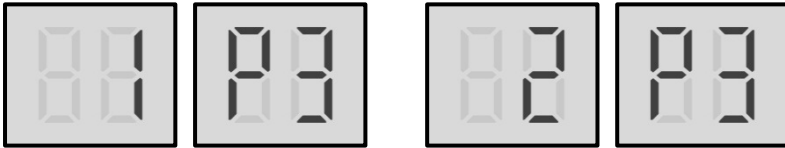

'x' is a placeholder for the compressor system (compressor and related electrical components), with 1 representing compressor system A and 2 representing compressor system B.

### 2.20.2 Description

- 1P3 indicates current protection on compressor A; 2P3 indicates current protection on compressor B.
- All units stop running.
- Error code is only displayed on the unit with the error.

### 2.20.3 Trigger / recover condition

- Trigger condition: Current of compressor AA55PHDG-A1Y2  $\geq$  41A or DC65PHDG-A1Y2  $\geq$  49A.
- Recover condition: Current of compressor AA55PHDG-A1Y2  $<$  41A or DC65PHDG-A1Y2  $<$  49A.
- Reset method: Resume automatically.

### 2.20.4 Possible causes

- Outdoor unit stop valves are closed.
- Indoor load too large.
- Power supply abnormal.
- Sudden interruption of power to IDUs.
- Excess refrigerant.
- System contains air or nitrogen.
- Poor condenser heat exchange.
- High pressure side blockage.
- Inverter module damaged.
- Compressor damaged.
- Main PCB damaged.

### 2.20.5 Procedure

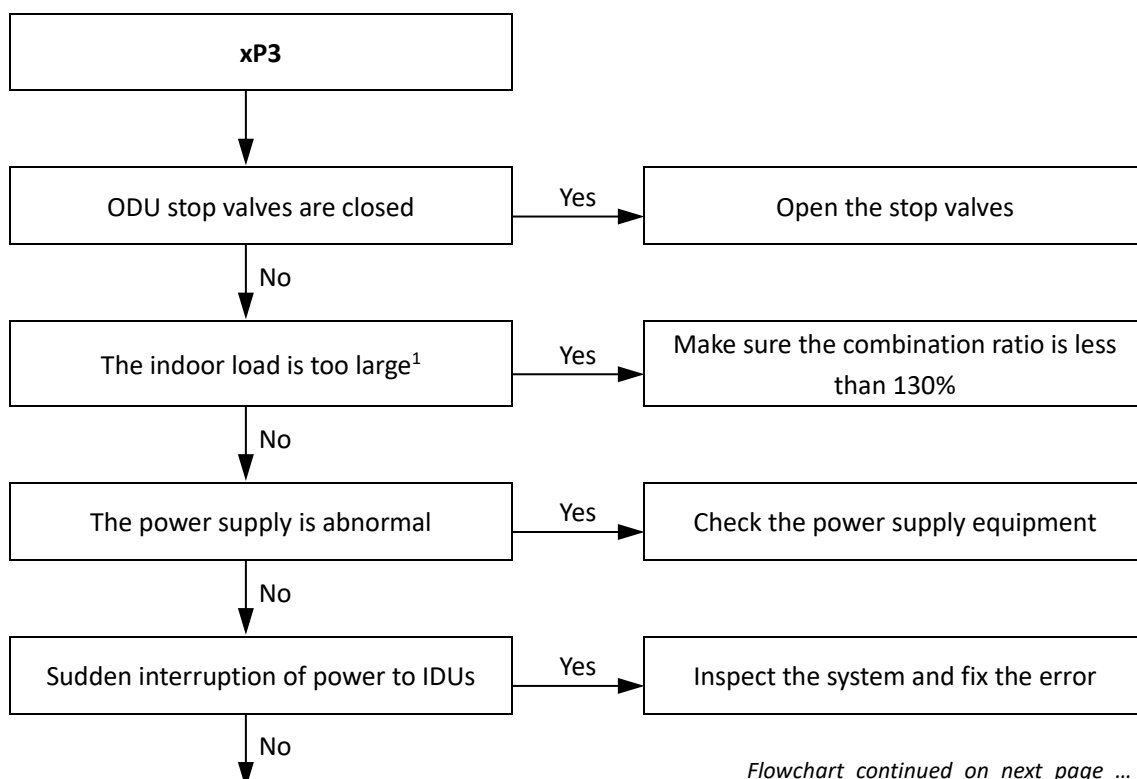

... flowchart continued from previous page

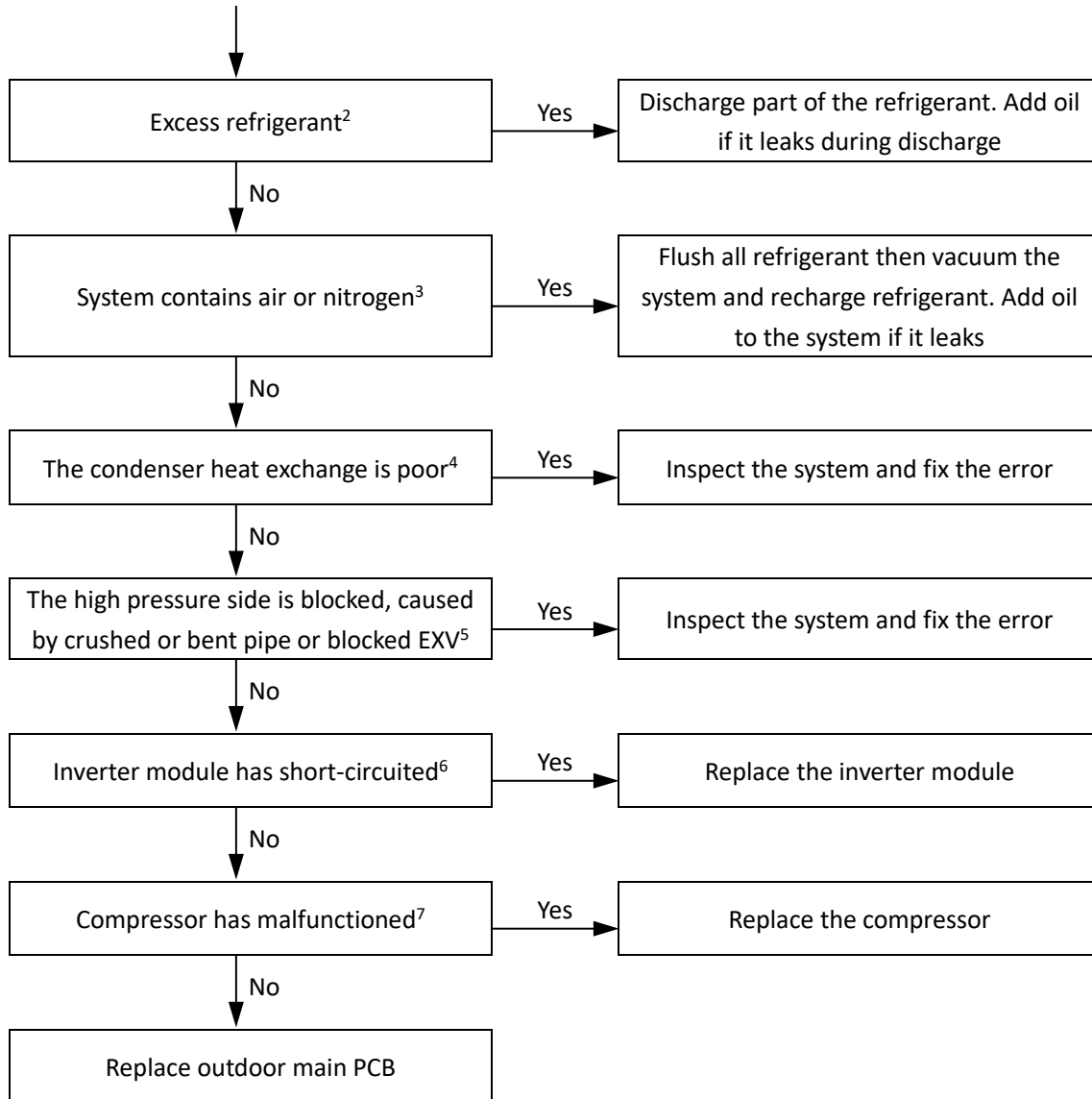

Notes:

1. An indoor load that is too large causes suction and discharge temperatures to be higher than normal. For normal system parameters refer to Table 6-3.4 and 6-3.5 in Part 6, 3.2 "Normal Operating Parameters of Refrigerant System".
2. Excess refrigerant causes discharge temperature to be lower than normal, discharge pressure to be higher than normal and suction pressure to be higher than normal. For normal system parameters refer to Table 6-3.4 and 6-3.5 in Part 6, 3.2 "Normal Operating Parameters of Refrigerant System".
3. Air or nitrogen in the system causes discharge temperature to be higher than normal, discharge pressure to be higher than normal, compressor current to be higher than normal, abnormal compressor noise and an unsteady pressure meter reading. For normal system parameters refer to Table 6-3.4 and 6-3.5 in Part 6, 3.2 "Normal Operating Parameters of Refrigerant System".
4. In cooling mode check outdoor heat exchangers, fans and air outlets for dirt/blockages. In heating mode check indoor heat exchangers, fans and air outlets for dirt/blockages.
5. High pressure side blockage causes discharge temperature to be higher than normal, discharge pressure to be higher than normal and suction pressure to be lower than normal. For normal system parameters refer to Table 6-3.4 and 6-3.5 in Part 6, 3.2 "Normal Operating Parameters of Refrigerant System".
6. Set a multi-meter to buzzer mode and test any two terminals of P N U V W of the inverter module. If the buzzer sounds, the inverter module has short-circuited.
7. The normal resistances of the inverter compressor are 0.05-0.15Ω among U V W and infinite between each of U V W and ground. If any of the resistances differ from these specifications, the compressor has malfunctioned.



## 2.21 P4, H6: Discharge temperature protection

### 2.21.1 Digital display output

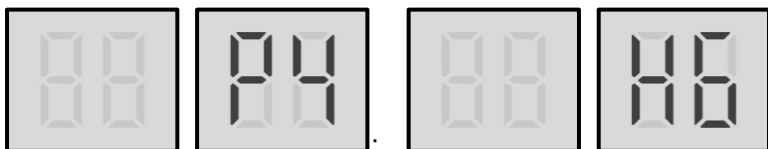

### 2.21.2 Description

- Discharge temperature protection.
- All units stop running.
- Error code is only displayed on the unit with the error.

### 2.21.3 Trigger / recover condition

- Trigger condition:
  - For P4 protection: Discharge temperature (T7C1/2)  $\geq 120^{\circ}\text{C}$ .
  - For H6 protection: P4 protection appears three times in 100 minutes.
- Recover condition: Discharge temperature (T7C1/2)  $\leq 90^{\circ}\text{C}$ .
- Reset method:
  - For P4 protection: Resume automatically.
  - For H6 protection: Manually restart.

### 2.21.4 Possible causes

- Outdoor unit stop valves are closed.
- Temperature sensor/switch not connected properly or has malfunctioned.
- Insufficient refrigerant.
- System blockage.
- Indoor load too large.
- System contains air or nitrogen.
- Poor condenser heat exchange.
- Main PCB damaged.

### 2.21.5 Procedure

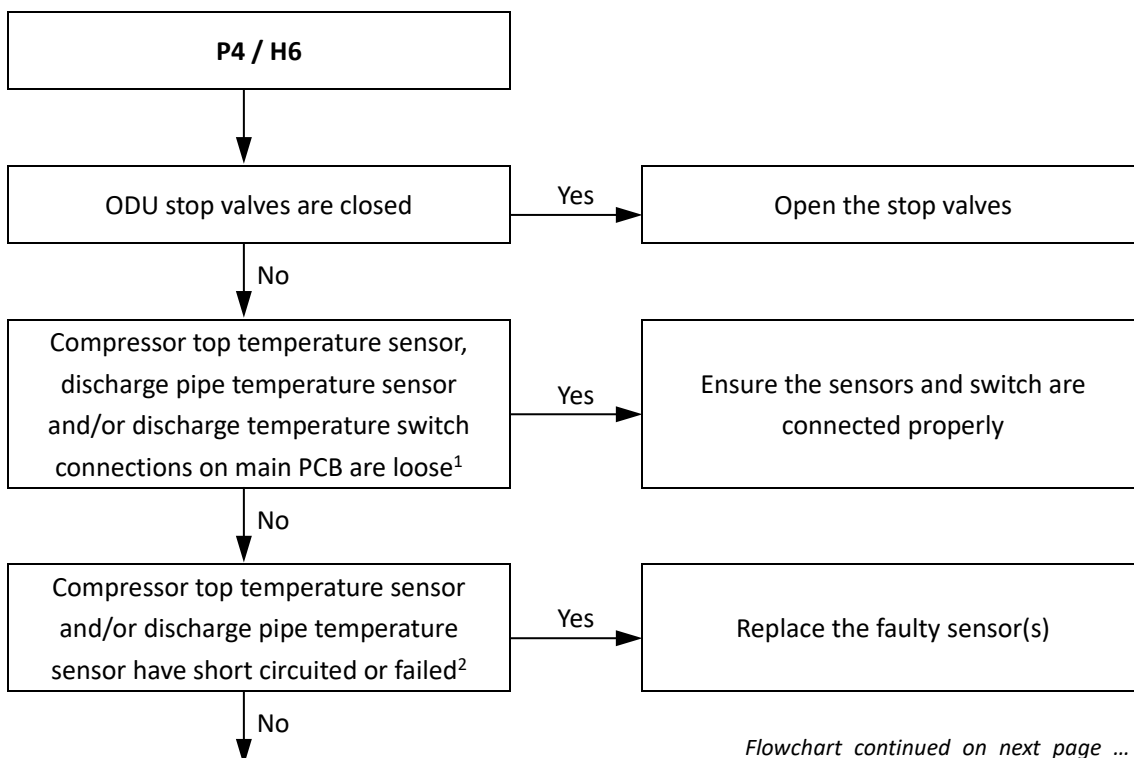

... flowchart continued from previous page

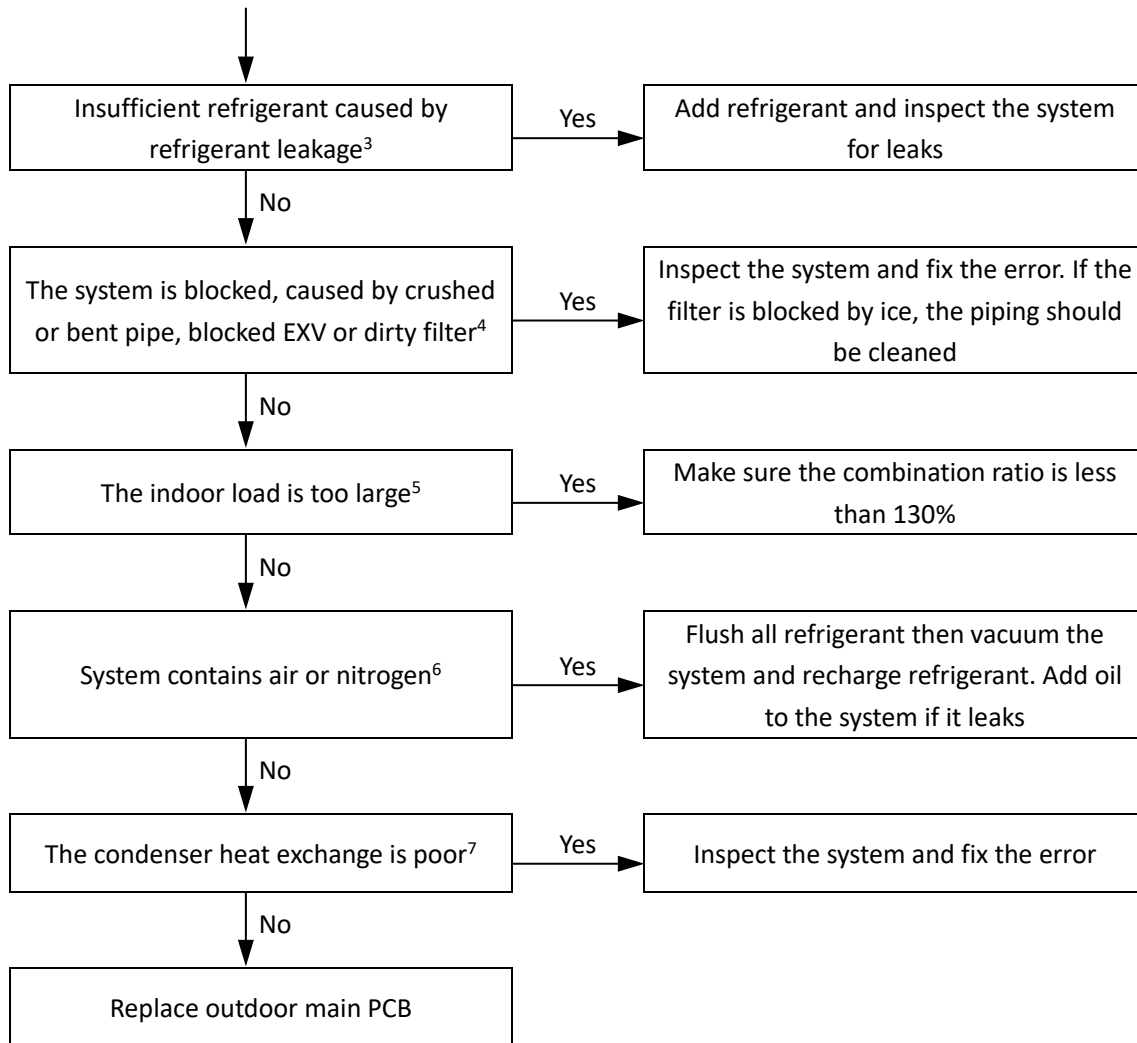

Notes:

1. Compressor top temperature sensor and discharge pipe temperature sensor connections are ports CN4 and CN5 on the main PCB (labeled 3 and 4, respectively, in Figure 5-2.1 in Part 5, 2.1 "Ports"). The discharge temperature switch connection is port CN19 on the main PCB (labeled 2 in Figure 5-2.1 in Part 5, 2.1 "Ports").
2. Measure sensor resistance. If the resistance is too low, the sensor has short-circuited. If the resistance is not consistent with the sensor's resistance characteristics table, the sensor has failed. Refer to Table 6-3.2 in Part 6, 3.1 "Temperature Sensor Resistance Characteristics".
3. An insufficiency of refrigerant causes compressor discharge temperature to be higher than normal, discharge and suction pressures to be lower than normal and compressor current to be lower than normal, and may cause frosting to occur on the suction pipe. These issues disappear once sufficient refrigerant has been charged into the system. For normal system parameters refer to Table 6-3.4 and 6-3.5 in Part 6, 3.2 "Normal Operating Parameters of Refrigerant System".
4. A low pressure side blockage causes compressor discharge temperature to be higher than normal, suction pressure to be lower than normal and compressor current to be lower than normal, and may cause frosting to occur on the suction pipe. For normal system parameters refer to Table 6-3.4 and 6-3.5 in Part 6, 3.2 "Normal Operating Parameters of Refrigerant System".
5. An indoor load that is too large causes suction and discharge temperatures to be higher than normal. For normal system parameters refer to Table 6-3.4 and 6-3.5 in Part 6, 3.2 "Normal Operating Parameters of Refrigerant System".
6. Air or nitrogen in the system causes discharge temperature to be higher than normal, discharge pressure to be higher than normal, compressor current to be higher than normal, abnormal compressor noise and an unsteady pressure meter reading. For normal system parameters refer to Table 6-3.4 and 6-3.5 in Part 6, 3.2 "Normal Operating Parameters of Refrigerant System".
7. In cooling mode check outdoor heat exchangers, fans and air outlets for dirt/blockages. In heating mode check indoor heat exchangers, fans and air outlets for dirt/blockages.

## 2.22 P5: Outdoor heat exchanger temperature protection

### 2.22.1 Digital display output

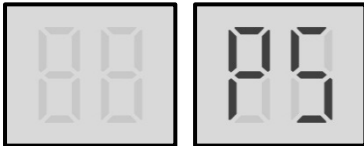

### 2.22.2 Description

- Outdoor heat exchanger temperature protection.
- All units stop running.
- Error code is only displayed on the unit with the error.

### 2.22.3 Trigger / recover condition

- Trigger condition: Outdoor heat exchanger temperature (T3)  $\geq 65^{\circ}\text{C}$ .
- Recover condition: Outdoor heat exchanger temperature (T3)  $< 55^{\circ}\text{C}$ .
- Reset method: Resume automatically.

### 2.22.4 Possible causes

- Outdoor unit stop valves are closed.
- Temperature sensor not connected properly or has malfunctioned.
- Indoor load too large.
- System contains air or nitrogen.
- Poor condenser heat exchange.
- High pressure side blockage.
- Main PCB damaged.

## 2.22.5 Procedure

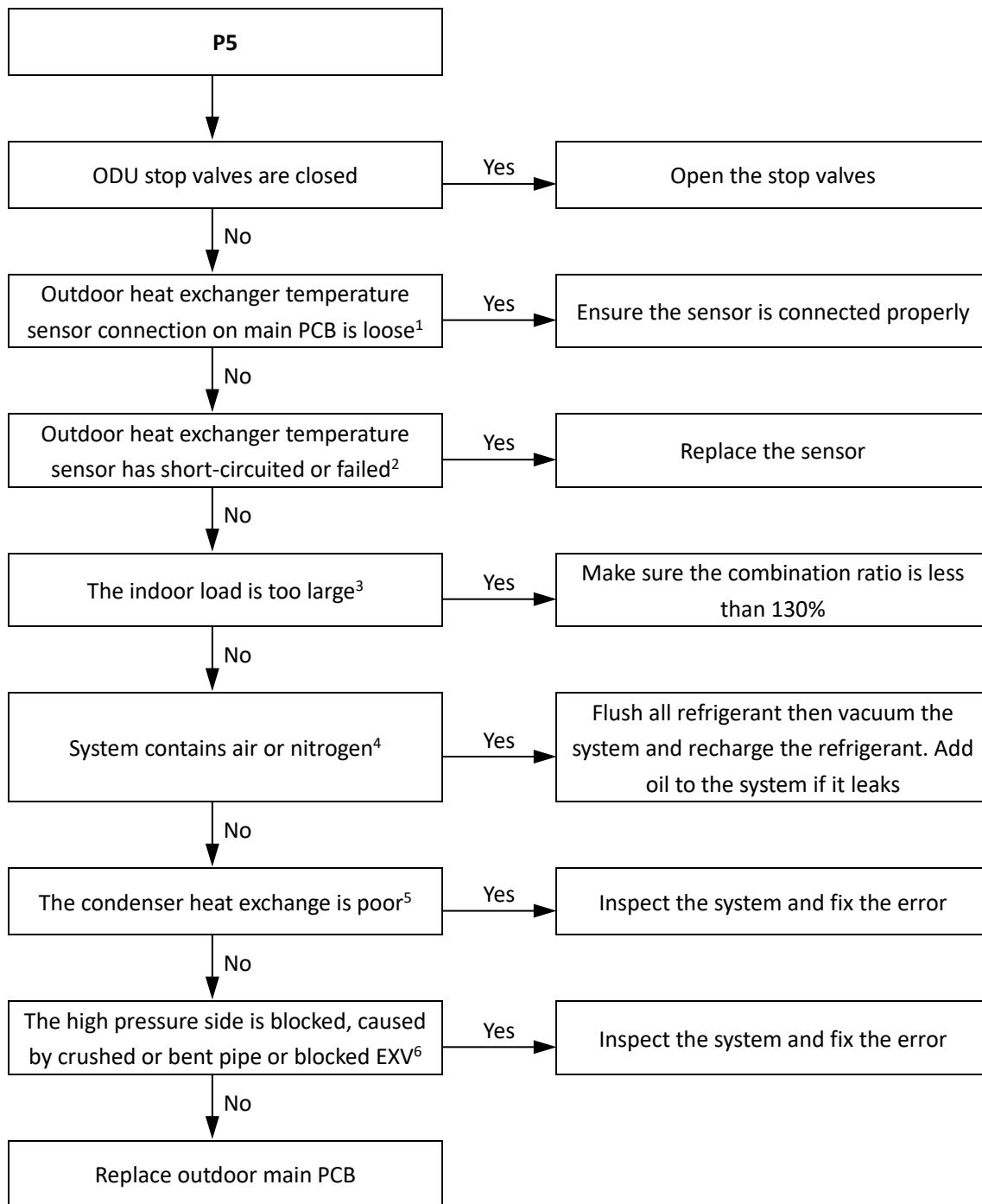

### Notes:

1. Outdoor heat exchanger temperature sensor connection is port CN1 on the main PCB (labeled 11 in Figure 5-2.1 in Part 5, 2.1 "Ports").
2. Measure sensor resistance. If the resistance is too low, the sensor has short-circuited. If the resistance is not consistent with the sensor's resistance characteristics table, the sensor has failed. Refer to Table 6-3.1 in Part 6, 3.1 "Temperature Sensor Resistance Characteristics"
3. An indoor load that is too large causes suction and discharge temperatures to be higher than normal. For normal system parameters refer to Table 6-3.4 and 6-3.5 in Part 6, 3.2 "Normal Operating Parameters of Refrigerant System".
4. Air or nitrogen in the system causes discharge temperature to be higher than normal, discharge pressure to be higher than normal, compressor current to be higher than normal, abnormal compressor noise and an unsteady pressure meter reading. For normal system parameters refer to Table 6-3.4 and 6-3.5 in Part 6, 3.2 "Normal Operating Parameters of Refrigerant System".
5. In cooling mode check outdoor heat exchangers, fans and air outlets for dirt/blockages. In heating mode check indoor heat exchangers, fans and air outlets for dirt/blockages.
6. High pressure side blockage causes discharge temperature to be higher than normal, discharge pressure to be higher than normal and suction pressure to be lower than normal. For normal system parameters refer to Table 6-3.4 and 6-3.5 in Part 6, 3.2 "Normal Operating Parameters of Refrigerant System".

## 2.23 P9, H9: Fan module protection

### 2.23.1 Digital display output

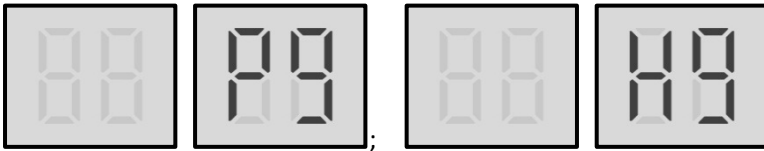

### 2.23.2 Description

- Fan module protection.
- All units stop running.
- Error code is only displayed on the unit with the error.

### 2.23.3 Trigger / recover condition

- Trigger condition:  
For P9 protection: Fan speed is too low.  
For H9 protection: P9 protection appears ten times in 120 minutes.
- Recover condition: Fan speed go back to normal.
- Reset method:  
For P9 protection: Resume automatically; For H9 protection: Manually restart.

### 2.23.4 Possible causes

- Switch ENC2 incorrectly set.
- Power or communication wires not connected properly.
- Fan motor blocked or has failed.
- Power supply abnormal.
- AC filter board damaged.
- Fan module damaged.
- Main PCB damaged.

### 2.23.5 Procedure

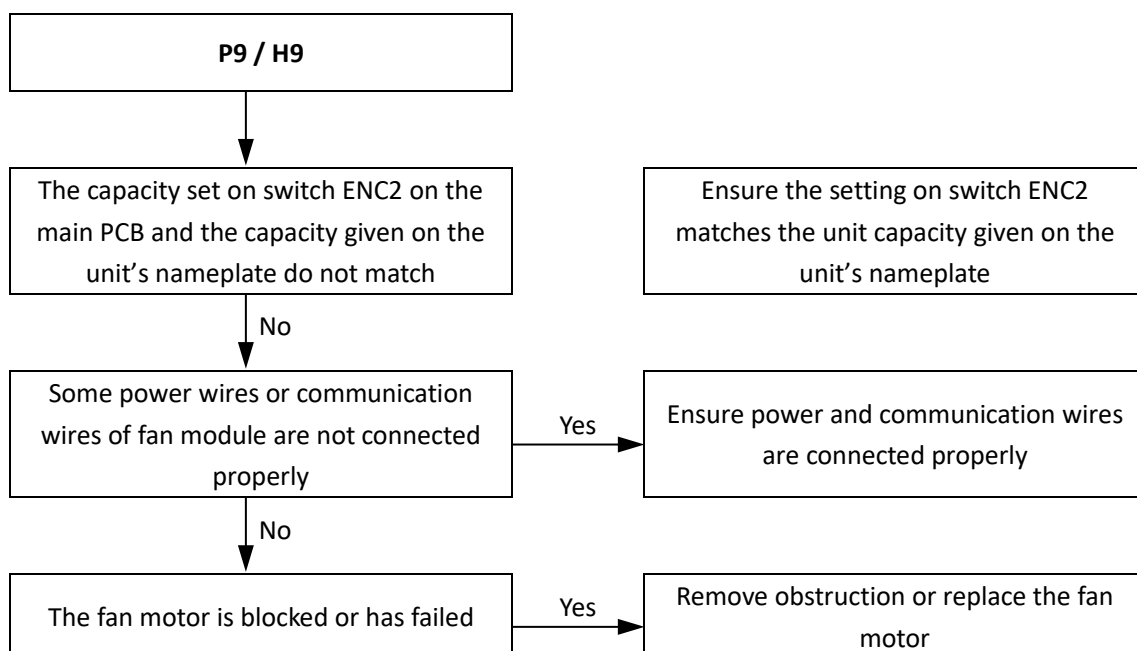

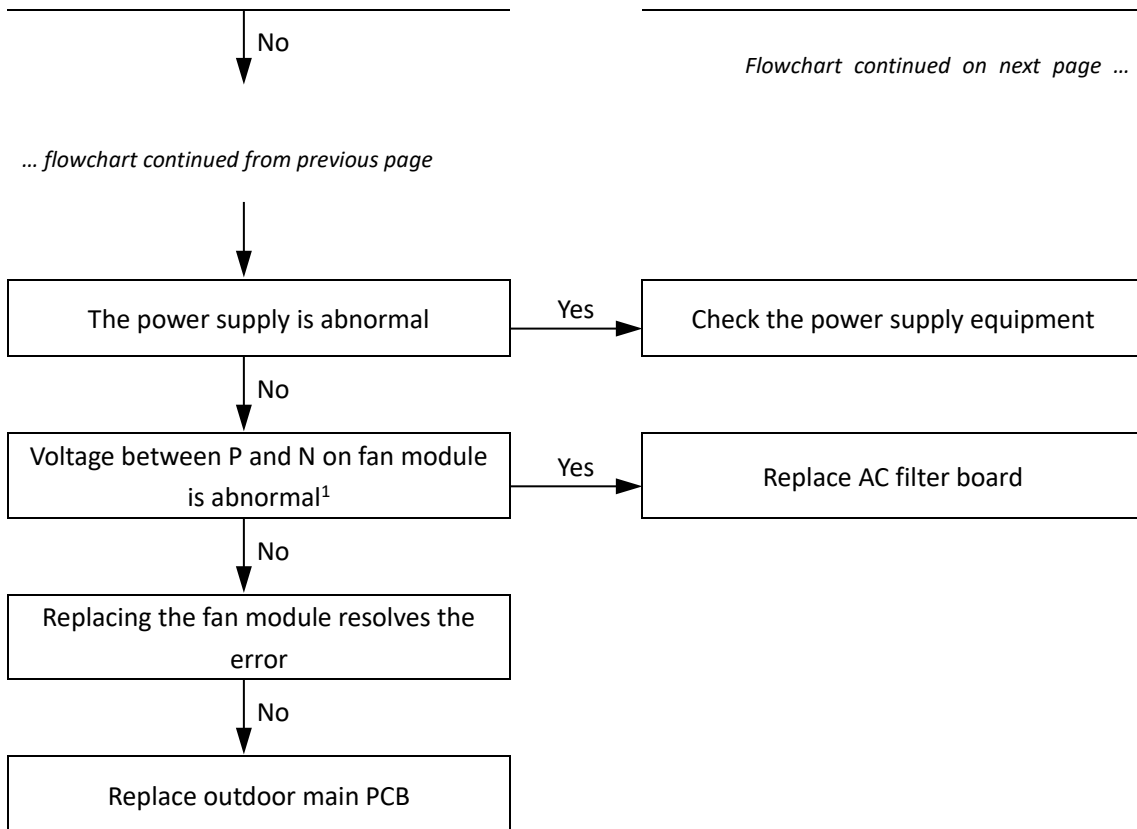

Notes:

1. The normal voltage between P and N on the fan module is 310V DC.

Figure 6-2.12: Fan module P N terminals

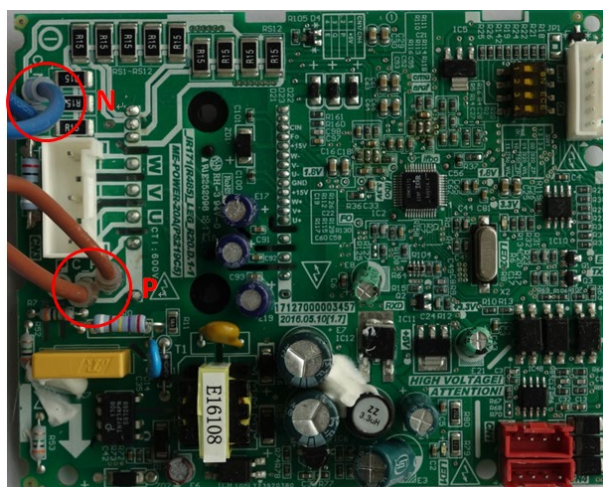

## 2.24 PL, C7: Inverter module temperature protection

### 2.24.1 Digital display output

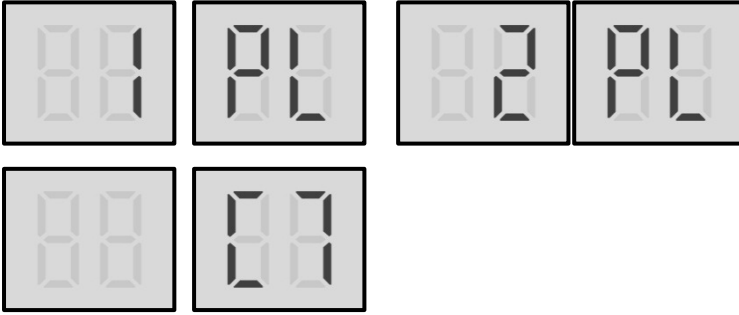

'x' is a placeholder for the compressor system (compressor and related electrical components), with 1 representing compressor system A and 2 representing compressor system B.

### 2.24.2 Description

- 1PL indicates inverter module A temperature protection.
- 2PL indicates inverter module B temperature protection.
- All units stop running.
- Error code is only displayed on the unit with the error.

### 2.24.3 Trigger / recover condition

- Trigger condition:
  - For PL protection: Inverter module heat sink temperature (TF1/2)  $\geq 80^{\circ}\text{C}$ .
  - For C7 protection: PL protection appears three times in 100 minutes.
- Recover condition: Inverter module heat sink temperature (TF1/2)  $< 65^{\circ}\text{C}$
- Reset method:
  - For PL protection: Resume automatically.
  - For C7 protection: Manually restart.

### 2.24.4 Possible causes

- Blocked, dirty or loose heat sink.
- Temperature sensor not connected properly or has malfunctioned.
- Main PCB damaged.

## 2.24.5 Procedure

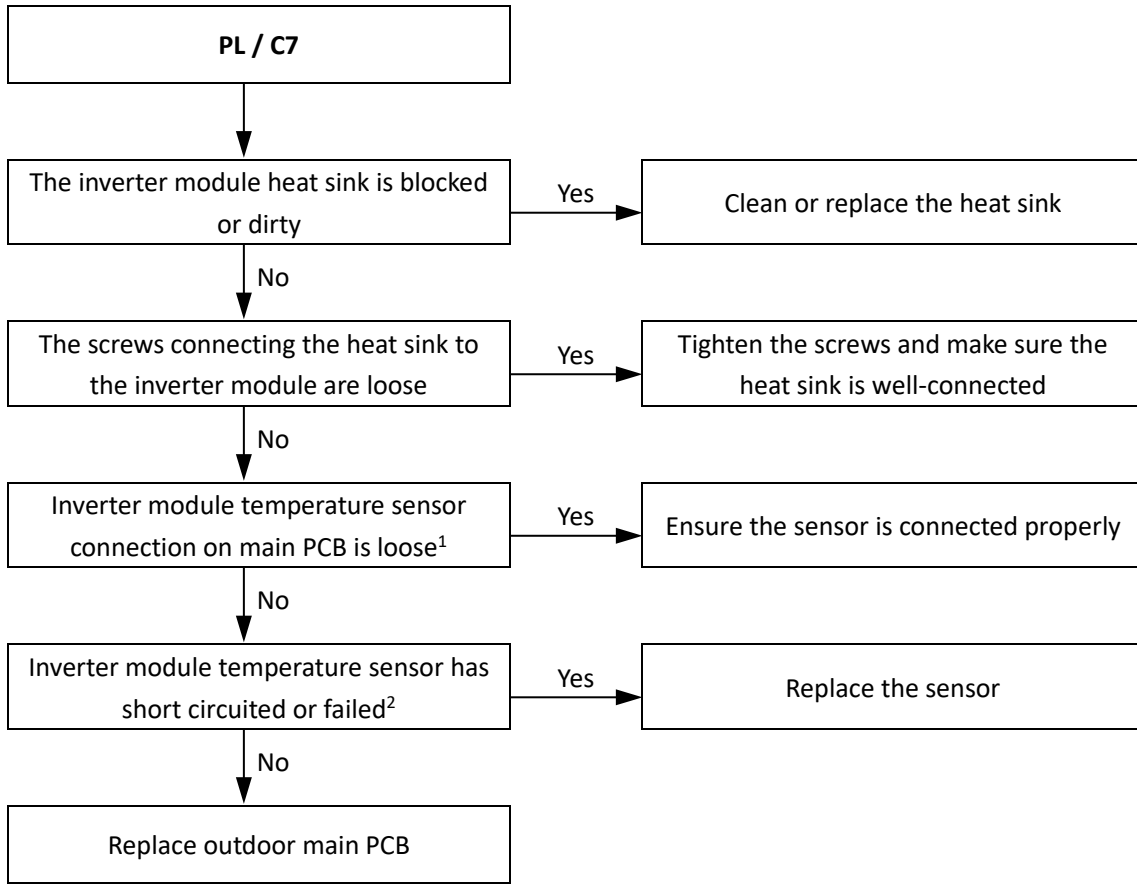

### Notes:

1. Inverter module temperature sensor connection is port CN3 and CN3\_1 on the main PCB (labeled 5 and 6, respectively, in Figure 5-2.1 in Part 5, 2.1 "Ports").
2. Measure sensor resistance. If the resistance is too low, the sensor has short-circuited. If the resistance is not consistent with the sensor's resistance characteristics table, the sensor has failed. Refer to Table 6-3.3 in Part 6, 3.1 "Temperature Sensor Resistance Characteristics".



## 2.25 PP: Compressor discharge insufficient superheat protection

### 2.25.1 Digital display output

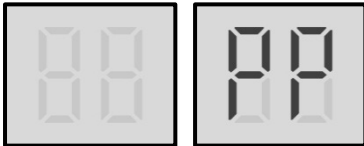

### 2.25.2 Description

- Compressor discharge insufficient superheat protection.
- All units stop running.
- Error code is only displayed on the unit with the error.

### 2.25.3 Trigger / recover condition

- Trigger condition: Discharge gas superheat is  $\leq 0^{\circ}\text{C}$  for 20 minutes or  $\leq 5^{\circ}\text{C}$  for 60 minutes.
- Recover condition: Discharge gas superheat go back to normal value.
- Reset method: Resume automatically.

### 2.25.4 Possible causes

- Temperature sensor not connected properly or has malfunctioned.
- Poor temperature sensor heat insulation.
- Excess refrigerant.
- Discharge pressure too high.
- Main PCB damaged.

## 2.25.5 Procedure

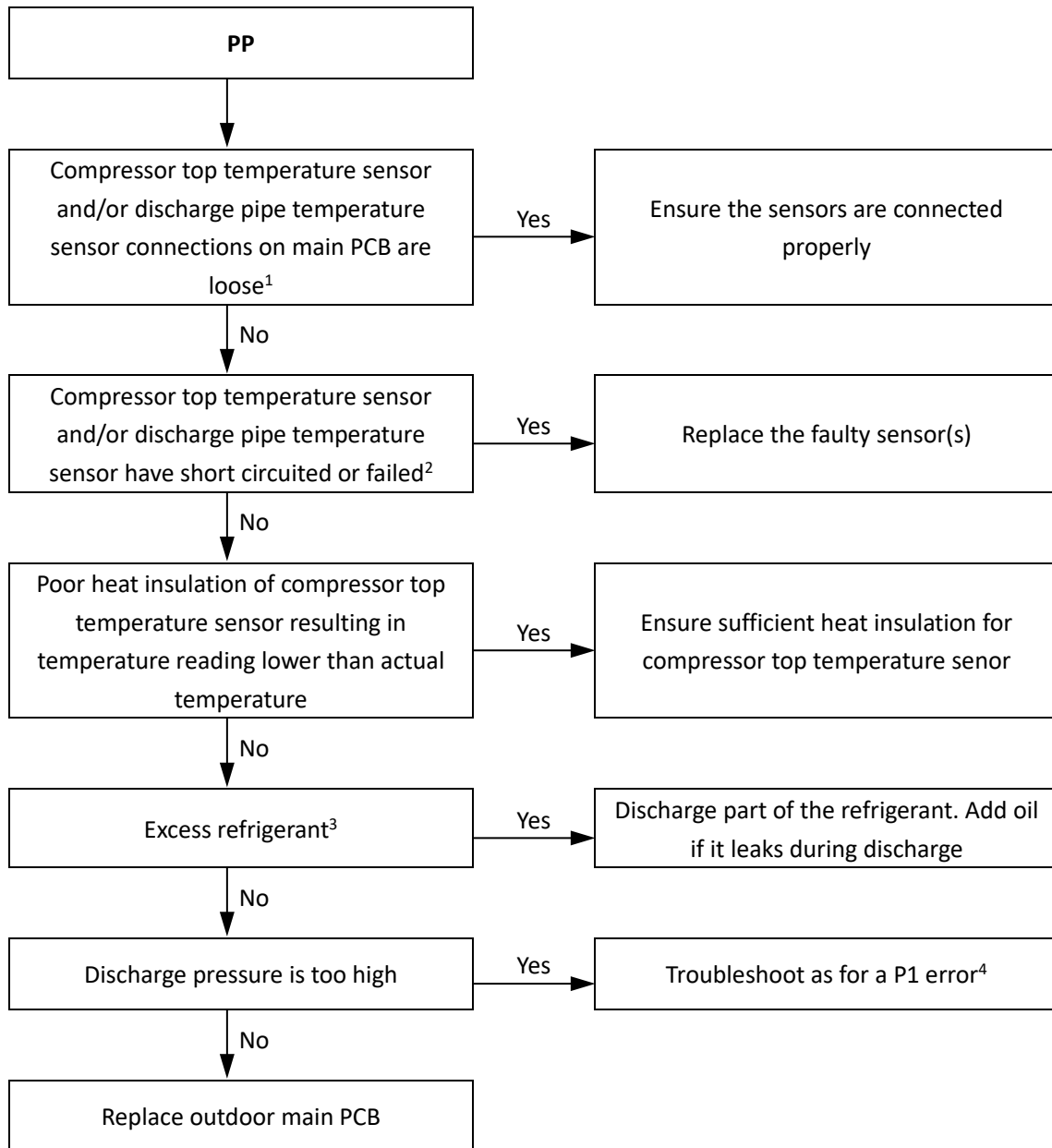

### Notes:

1. Compressor top temperature sensor and discharge pipe temperature sensor connections are ports CN4 and CN5 on the main PCB (labeled 3 and 4, respectively, in Figure 5-2.1 in Part 5, 2.1 "Ports").
2. Measure sensor resistance. If the resistance is too low, the sensor has short-circuited. If the resistance is not consistent with the sensor's resistance characteristics table, the sensor has failed. Refer to Table 6-3.2 in Part 6, 3.1 "Temperature Sensor Resistance Characteristics".
3. Excess refrigerant causes discharge temperature to be lower than normal, discharge pressure to be higher than normal and suction pressure to be higher than normal. For normal system parameters refer to Table 6-3.4 and 6-3.5 in Part 6, 3.2 "Normal Operating Parameters of Refrigerant System".
4. See "P1 Troubleshooting".

### 3 Appendix to Part 6

#### 3.1 Temperature Sensor Resistance Characteristics

Table 6-3.1: Outdoor ambient temperature sensor and outdoor heat exchanger temperature sensor resistance characteristics

Temperature (°C)	Resistance (kΩ)	Temperature (°C)	Resistance (kΩ)	Temperature (°C)	Resistance (kΩ)	Temperature (°C)	Resistance (kΩ)
-20	115.3	20	12.64	60	2.358	100	0.6297
-19	108.1	21	12.06	61	2.272	101	0.6115
-18	101.5	22	11.50	62	2.191	102	0.5939
-17	96.34	23	10.97	63	2.112	103	0.5768
-16	89.59	24	10.47	64	2.037	104	0.5604
-15	84.22	25	10.00	65	1.965	105	0.5445
-14	79.31	26	9.551	66	1.896	106	0.5291
-13	74.54	27	9.124	67	1.830	107	0.5143
-12	70.17	28	8.720	68	1.766	108	0.4999
-11	66.09	29	8.336	69	1.705	109	0.4860
-10	62.28	30	7.971	70	1.647	110	0.4726
-9	58.71	31	7.624	71	1.591	111	0.4596
-8	56.37	32	7.295	72	1.537	112	0.4470
-7	52.24	33	6.981	73	1.485	113	0.4348
-6	49.32	34	6.684	74	1.435	114	0.4230
-5	46.57	35	6.400	75	1.387	115	0.4116
-4	44.00	36	6.131	76	1.341	116	0.4006
-3	41.59	37	5.874	77	1.291	117	0.3899
-2	39.82	38	5.630	78	1.254	118	0.3796
-1	37.20	39	5.397	79	1.2133	119	0.3695
0	35.20	40	5.175	80	1.174	120	0.3598
1	33.33	41	4.964	81	1.136	121	0.3504
2	31.56	42	4.763	82	1.100	122	0.3413
3	29.91	43	4.571	83	1.064	123	0.3325
4	28.35	44	4.387	84	1.031	124	0.3239
5	26.88	45	4.213	85	0.9982	125	0.3156
6	25.50	46	4.046	86	0.9668	126	0.3075
7	24.19	47	3.887	87	0.9366	127	0.2997
8	22.57	48	3.735	88	0.9075	128	0.2922
9	21.81	49	3.590	89	0.8795	129	0.2848
10	20.72	50	3.451	90	0.8525	130	0.2777
11	19.69	51	3.318	91	0.8264	131	0.2708
12	18.72	52	3.192	92	0.8013	132	0.2641
13	17.80	53	3.071	93	0.7771	133	0.2576
14	16.93	54	2.959	94	0.7537	134	0.2513
15	16.12	55	2.844	95	0.7312	135	0.2451
16	15.34	56	2.738	96	0.7094	136	0.2392
17	14.62	57	2.637	97	0.6884	137	0.2334
18	13.92	58	2.540	98	0.6682	138	0.2278
19	13.26	59	2.447	99	0.6486	139	0.2223

Table 6-3.2: Compressor top temperature sensor and discharge pipe temperature sensor resistance characteristics

Temperature (°C)	Resistance (kΩ)	Temperature (°C)	Resistance (kΩ)	Temperature (°C)	Resistance (kΩ)	Temperature (°C)	Resistance (kΩ)
-20	542.7	20	68.66	60	13.59	100	3.702
-19	511.9	21	65.62	61	13.11	101	3.595
-18	483.0	22	62.73	62	12.65	102	3.492
-17	455.9	23	59.98	63	12.21	103	3.392
-16	430.5	24	57.37	64	11.79	104	3.296
-15	406.7	25	54.89	65	11.38	105	3.203
-14	384.3	26	52.53	66	10.99	106	3.113
-13	363.3	27	50.28	67	10.61	107	3.025
-12	343.6	28	48.14	68	10.25	108	2.941
-11	325.1	29	46.11	69	9.902	109	2.860
-10	307.7	30	44.17	70	9.569	110	2.781
-9	291.3	31	42.33	71	9.248	111	2.704
-8	275.9	32	40.57	72	8.940	112	2.630
-7	261.4	33	38.89	73	8.643	113	2.559
-6	247.8	34	37.30	74	8.358	114	2.489
-5	234.9	35	35.78	75	8.084	115	2.422
-4	222.8	36	34.32	76	7.820	116	2.357
-3	211.4	37	32.94	77	7.566	117	2.294
-2	200.7	38	31.62	78	7.321	118	2.233
-1	190.5	39	30.36	79	7.086	119	2.174
0	180.9	40	29.15	80	6.859	120	2.117
1	171.9	41	28.00	81	6.641	121	2.061
2	163.3	42	26.90	82	6.430	122	2.007
3	155.2	43	25.86	83	6.228	123	1.955
4	147.6	44	24.85	84	6.033	124	1.905
5	140.4	45	23.89	85	5.844	125	1.856
6	133.5	46	22.89	86	5.663	126	1.808
7	127.1	47	22.10	87	5.488	127	1.762
8	121.0	48	21.26	88	5.320	128	1.717
9	115.2	49	20.46	89	5.157	129	1.674
10	109.8	50	19.69	90	5.000	130	1.632
11	104.6	51	18.96	91	4.849		
12	99.69	52	18.26	92	4.703		
13	95.05	53	17.58	93	4.562		
14	90.66	54	16.94	94	4.426		
15	86.49	55	16.32	95	4.294		
16	82.54	56	15.73	96	4.167		
17	78.79	57	15.16	97	4.045		
18	75.24	58	14.62	98	3.927		
19	71.86	59	14.09	99	3.812		

Table 6-3.3: Inverter module temperature sensor resistance characteristics

Temperature (°C)	Resistance (kΩ)	Temperature (°C)	Resistance (kΩ)	Temperature (°C)	Resistance (kΩ)	Temperature (°C)	Resistance (kΩ)
-30	971.4	10	109.0	50	19.70	90	5.000
-29	912.8	11	103.9	51	18.97	91	4.855
-28	858.2	12	99.02	52	18.26	92	4.705
-27	807.3	13	94.44	53	17.59	93	4.566
-26	759.7	14	90.11	54	16.94	94	4.431
-25	715.3	15	86.00	55	16.32	95	4.301
-24	673.6	16	82.09	56	15.73	96	4.176
-23	634.7	17	78.38	57	15.16	97	4.055
-22	598.2	18	74.87	58	14.62	98	3.938
-21	564.1	19	71.53	59	14.10	99	3.825
-20	532.2	20	68.36	60	13.60	100	3.716
-19	502.2	21	65.34	61	13.12	101	3.613
-18	474.1	22	62.47	62	12.65	102	3.514
-17	447.7	23	59.75	63	12.22	103	3.418
-16	423.0	24	57.17	64	11.79	104	3.326
-15	399.8	25	54.71	65	11.39	105	3.235
-14	378.0	26	52.36	66	10.99	106	3.148
-13	357.5	27	50.13	67	10.62	107	3.063
-12	338.2	28	48.01	68	10.25	108	2.982
-11	320.1	29	45.99	69	9.909	109	2.902
-10	303.1	30	44.07	70	9.576	110	2.826
-9	287.1	31	42.23	71	9.253	111	2.747
-8	272.0	32	40.48	72	8.947	112	2.672
-7	257.8	33	38.81	73	8.646	113	2.599
-6	244.4	34	37.23	74	8.362	114	2.528
-5	231.9	35	35.71	75	8.089	115	2.460
-4	220.0	36	34.27	76	7.821	116	2.390
-3	208.7	37	32.89	77	7.569	117	2.322
-2	198.2	38	31.58	78	7.323	118	2.256
-1	188.2	39	30.33	79	7.088	119	2.193
0	178.8	40	29.13	80	6.858	120	2.132
1	169.9	41	27.98	81	6.640	121	2.073
2	161.5	42	26.89	82	6.432	122	2.017
3	153.6	43	25.85	83	6.230	123	1.962
4	146.1	44	24.85	84	6.033	124	1.910
5	139.1	45	23.90	85	5.847	125	1.859
6	132.3	46	22.98	86	5.667		
7	126.0	47	22.10	87	5.492		
8	120.0	48	21.26	88	5.322		
9	114.3	49	20.47	89	5.159		

### 3.2 Normal Operating Parameters of Refrigerant System

Under the following conditions, the operating parameters given in Tables 6-3.4 and 6-3.5 should be observed:

- The master outdoor unit can detect all the indoor units.
- The number of indoor units displayed on DSP2 is steady and is equal to the actual number of indoor units installed.
- All stop valves are open and all indoor unit EXVs are connected to their unit’s PCB.
- If the combination ratio is 100% or less, all the indoor units are currently running and if the combination ratio is more than 100%, indoor units with total capacity equal to the total capacity of the outdoor units are currently running.
- If the outdoor ambient temperature is high, the system is being run in cooling mode with the following settings: temperature 17°C; fan speed high.
- If the outdoor ambient temperature is low, the system is being run in heating mode with the following settings: temperature 30°C; fan speed high.
- The system has been running normally for more than 30 minutes.

Table 6-3.4: Outdoor unit cooling mode operating parameters

<b>Outdoor ambient temperature</b>	<b>°C</b>	< 10	10 to 26	26 to 31	31 to 41	> 41
<b>Discharge temperature</b>	<b>°C</b>	60-76	62-78	65-82	67-92	69-92
<b>Discharge superheat</b>	<b>°C</b>	17-30	17-33	17-34	17-36	10-32
<b>Discharge pressure</b>	<b>MPa</b>	2.3-2.8	2.3-2.8	2.4-3.6	2.6-3.8	3.1-4.2
<b>Suction pressure</b>	<b>MPa</b>	0.6-0.7	0.7-0.9	0.8-1.0	1.0-1.2	1.2-1.4
<b>DC inverter compressor current</b>	<b>A</b>	9-32	11-38	20-44	26-44	20-42

Table 6-3.5: Outdoor unit heating mode operating parameters

<b>Outdoor ambient temperature</b>	<b>°C</b>	< -10	-10 to 0	0 to 5	5 to 10	10 to 17	> 17
<b>Discharge temperature</b>	<b>°C</b>	56-74	57-76	58-78	61-82	63-82	63-82
<b>Discharge superheat</b>	<b>°C</b>	17-35	17-35	17-35	17-33	14-33	14-33
<b>Discharge pressure</b>	<b>MPa</b>	1.7-2.4	1.8-2.5	1.9-3.0	2.2-3.2	2.3-3.2	2.3-3.2
<b>Suction pressure</b>	<b>MPa</b>	1.4-1.6	1.5-1.7	1.6-2.2	1.8-2.6	1.8-2.6	2.0-2.4
<b>DC inverter compressor current</b>	<b>A</b>	14-38	15-38	16-40	20-40	18-42	12-35