



TRANE®



**MITSUBISHI
ELECTRIC**

CITYMULTI® VRF



mitsubishi electric trane hvac us is a leader in advanced hvac systems.

When it comes to providing personalized comfort in every room of every building, we are here to help. No other company is as committed to creating environmentally friendly and affordable technology that's ideal for today's home and work environments, no matter the size or shape.

QUALITY

Trane®/Mitsubishi Electric is consistently recognized by HVAC contractors as a preferred brand of ductless and variable refrigerant flow (VRF) systems, with the highest quality rating among manufacturers. With over 30 years of industry leadership, we are proud to be a leading brand of VRF technology.

PERFORMANCE

We deliver a complete range of compact and powerful heat pump and heat recovery products that are also intelligent, quiet, and use energy efficiently.

TRAINING

We provide comprehensive product and applications instruction through our regional training centers across the United States and Mexico.

SUPPORT

We offer the most extensive network of experienced VRF zoning system professionals to provide project consultation in the areas of application planning and design, plus installation and start-up. Post installation, we provide support, including user training and operation monitoring.

GROWTH

Our products and services provide opportunities for architects, engineers, distributors and contractors to enhance and grow their businesses. With nearly 30 years of consistent growth, we continue to lead the ductless and VRF market's acceleration.

ECO CHANGES

Eco Changes is our commitment to continuously strive for a greener tomorrow through cutting-edge global environmental technologies and outstanding strength in manufacturing.

TABLE OF CONTENTS

Overview of CITY MULTI®	5
Product Advantages	10

OUTDOOR UNITS

Outdoor Units Showcase	14
R2-Series	17
H2i® R2-Series	20
Y-Series	21
H2i Y-Series	23
S-Series (TUMY)	25
W-Series	27
Low Ambient Cooling Kit	29
Cold Weather Solutions Guide	30
Linear Expansion Valve (LEV) Kit	32

INDOOR UNITS

Indoor Units Overview	36
TPKFYP (Wall-mounted)	37
TPLFYP (Four-way Ceiling Cassette)	38
TPMFYP (One-way Ceiling Cassette)	41
TPCFYP (Ceiling-suspended)	42
TPEFYP (Ceiling-concealed Ducted)	43
FB (M,L,H) Filter Boxes	45
TPPFYP (Floor-standing)	46
TPVFYP (Multi-position Air Handler)	47
TPWFYP (Hydronic Heat Exchanger)	48

VENTILATION

Lossnay® Energy Recovery Ventilators (ERVs)	52
Dedicated Outdoor Air System (DOAS)	53
TPEFYP-OA	54

CONTROLS AND SOFTWARE TOOLS

Controls network	58
Integrated Centralized Control Web	59
Centralized Controller TE-200A / TE-50A	60
Centralized Controller TW-50A	62
Centralized Controller TT-24B-J	63
License Options for Centralized Controllers	64
Input/Output Controllers	65
Zone Controllers	67
Touch MA & kumo cloud®	68
Wired MA & Simple MA	69
Wireless MA	70
System Integration	71
Diamond System Builder	72
Maintenance Tool	74

SPECIFICATIONS

Outdoor Units	76
Indoor Units	109
Ventilation	119





Ease of Installation SERVICEABILITY

Cost $DI = 0.4(tc)$

EFFICIENT Social R
FEASIBILITY

WHY CITY MULTI® VRF SYSTEMS?

As a global leader in VRF zoning solutions, you can trust that you're receiving the most advanced technology and dedicated support in the industry.

CITY MULTI ADVANTAGES:

- ▶ **Ultra-efficient design** to ensure total comfort in any commercial space
- ▶ **Advanced INVERTER technology** varies the speed of the compressor for more efficient cooling and heating
- ▶ **Complete zoning control** so you heat and cool the areas that need it without paying for the ones that don't
- ▶ **Design flexibility** for any application, from modern designs to historic renovations
- ▶ **Complete product family** to handle every job from the smallest spaces to the largest buildings and campuses
- ▶ **Sustainable technology** that contributes to Leadership in Energy & Environmental Design (LEED) credits and saves energy
- ▶ **Quiet operation** that's even softer than a human whisper
- ▶ **Simultaneous operation** to heat and cool with just two refrigerant pipes

QUIET OPERATION

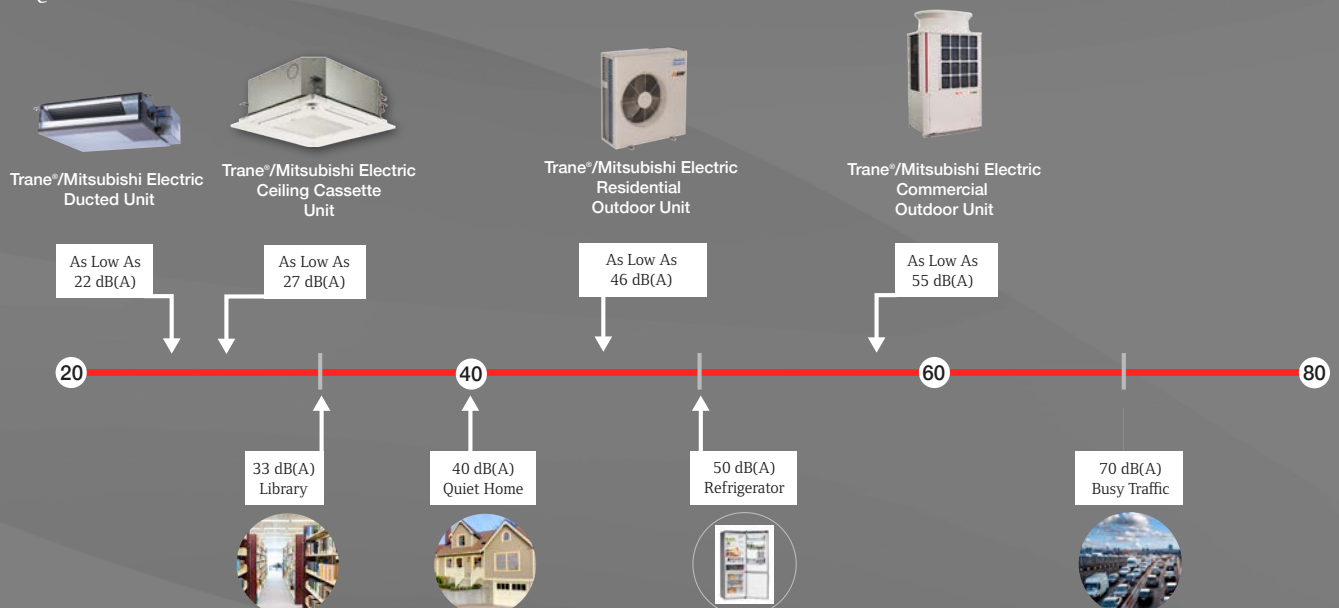

OUTDOOR UNITS

Trane®/Mitsubishi Electric VRF lineup of air sourced units that can be tailored to any application's requirements.

HEAT RECOVERY



R2-Series / H2i® R2-Series
(Air-Source)



WR2-Series
(Water-Source)

HEAT PUMP



Y-Series / H2i® Y-Series
(Air-Source)



S-Series / H2i® S-Series
(TUMY)
(Air-Source)



WY-Series
(Water-Source)

INDOOR UNITS

Trane®/Mitsubishi Electric's wide range of indoor units enables you to choose the style and size that meets your requirements for layout and design.



TPLFYP-EM140A (33"x33")
TPLFYP-FM140A (22"x22")
Ceiling Cassette (4-way)



TPMFYP
Ceiling Cassette (1-way)



TPCFYP
Ceiling-suspended



TPVFYP
Multi-position Air Handler



TPKFYP
Wall-mounted



TPWFYP-AU141A (HEX)
TPWFYP-BU140A (Booster)
Hydronic Heat Exchanger

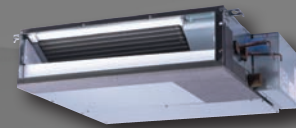

TPEFYP-MS140C Low Profile
TPEFYP-MA143A Medium Static
TPEFYP-MH142A/MH140A High Static
Ceiling-concealed Ducted



TPFFYP-CS Exposed
TPFFYP-RE Concealed
Floor-standing

CITY MULTI® CONTROLS NETWORK (CMCN)

The flexibility of CITY MULTI controls allows you to select the level of control and integration that fits the needs of your application.

CENTRALIZED CONTROLLERS



TE-200A/TE-50A
Touch Screen
Centralized Controllers
(Browser Capable)



TW-50A
Centralized Controller
(Browser Capable)



TT-24B-J
Touch Screen
Centralized Controller



ICCW
Integrated Centralized
Control Web

ZONE CONTROLLERS



TAR-FL32MA-E
Wireless MA
Wireless Remote Controller



TAC-YT53CRAU-J
Simple MA
Remote Controller



PAR-33MAA-J
Wired MA
Remote Controller



TAR-U01MEDU-K SmartME
Controller®



TZ-60DR-E
Lossnay® Remote Controller



PZ-43SMF
Lossnay Remote Controller



TAR-CT01MAU-SB
Touch MA
Remote Controller

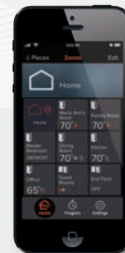

kumo cloud®
App-based Controller

CUSTOM CONTROLS SOLUTIONS

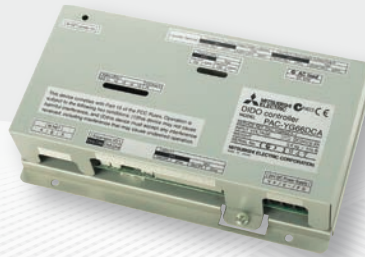

PACY-YG60MCA (PI)
PAC-YG63MCA (AI)
PAC-YG66DCA (DIDO)
I/O Control Boards



LMAP04U
LonWorks® Interface



PAC-US444CN
Thermostat Interface

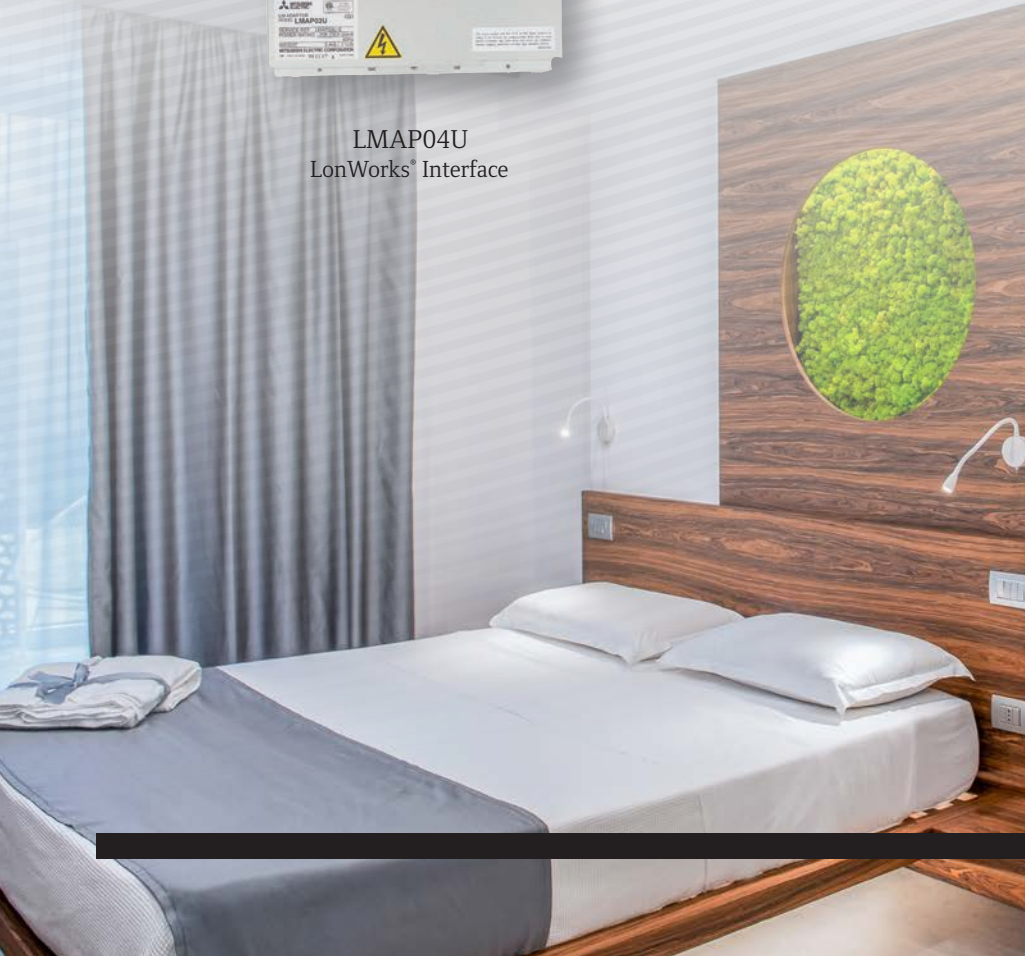

CITY MULTI[®] HIGH-PERFORMANCE, MODULAR VRF SYSTEMS

CITY MULTI outdoor units feature a lightweight modular design with a minimal footprint, lower sound level, easy piping, maintenance and much more.

1 INVERTER-DRIVEN COMPRESSOR TECHNOLOGY

The compressor varies its speed to match the indoor cooling or heating demand to consume only the energy required. No other compressor design can match the efficient performance.

2 EASY MAINTENANCE

In many cases, our systems allow an indoor unit to be serviced while other indoor units within the same piping system are still in operation. Indoor units only require periodic filter changes and cleaning. Protective coating comes standard on air-source outdoor units to lengthen coil life while additional Bermuda Special treatment, designated -BS within the model number, provides enhanced protection for the rest of the outdoor unit in sea-coast environments.

3 LONG LINE LENGTHS

The R2- and Y-Series outdoor units allow for long line lengths to the connected indoor units. Maximum total length of refrigerant piping is up to 2,624 feet for R2-Series and up to 3,280 feet for Y-Series.

4 ADJUSTABLE STATIC PRESSURE

R2-, Y- and H2i R2- and Y-Series outdoor fan features adjustable static pressure up to 0.32" W.G., enabling the use of louvers or ductwork in its installation. The static pressure setting is adjustable by changing a dip switch. The default setting is 0" W.G., with options for 0.12", 0.24" and 0.32" W.G.

5 QUIET OPERATION

CITY MULTI air-source outdoor units operate at sound levels as low as 55 dB(A)—the level of a common office environment, restaurant conversation or background music. Water-source units operate as low as 47 dB(A). Contributing features include our INVERTER-driven compressor compartment sealed by insulation-lined metal panels, vibration-absorbing compressor mounts, inverter-driven fan and Low Noise operating mode.

LOW AMBIENT OPERATION

CITY MULTI systems provide 100% cooling capacity down to -10° F with the optional low ambient kit. Systems provide guaranteed heating capacity down to -22° F, with operation possible to -31° F (N-Generation H2i[®] Units).

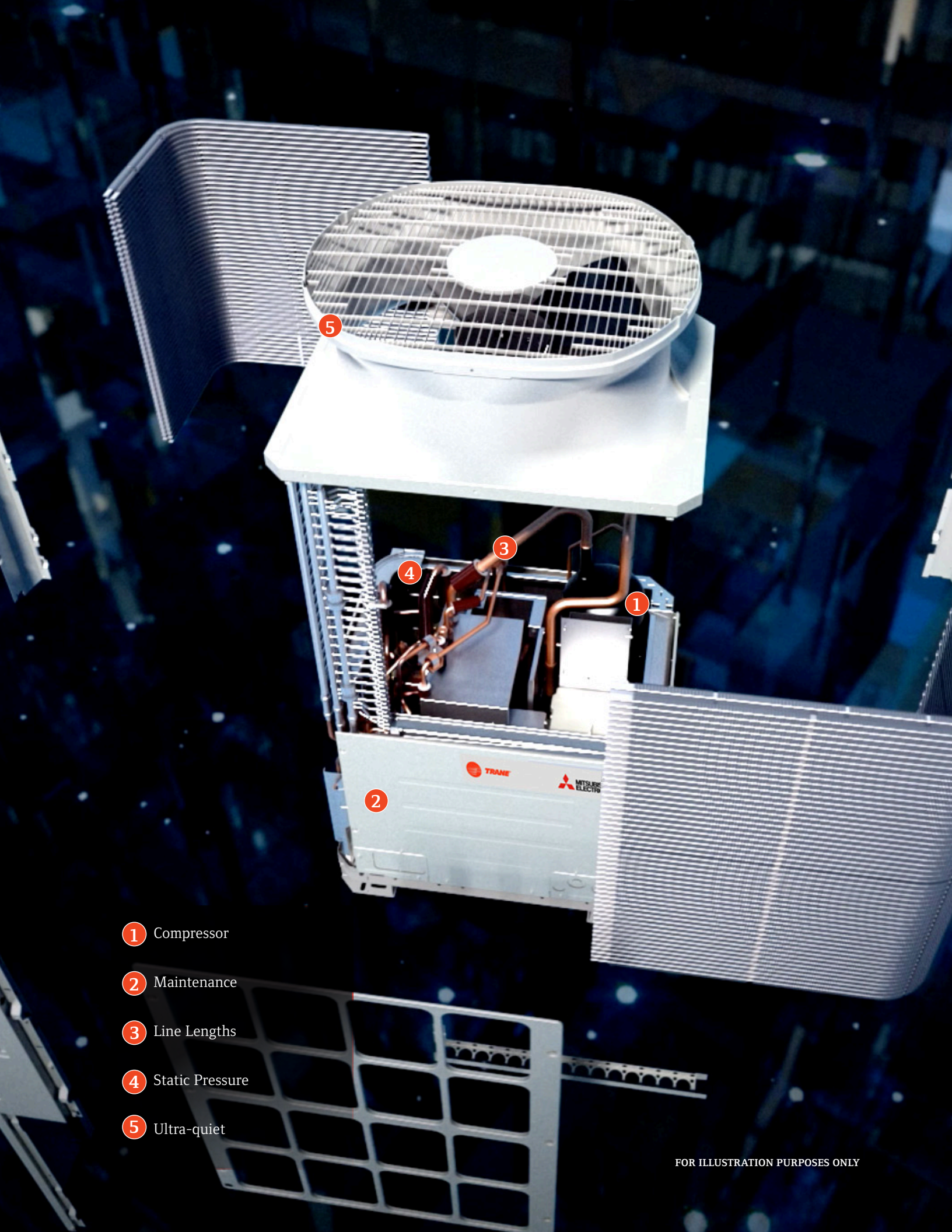

1 Compressor

2 Maintenance

3 Line Lengths

4 Static Pressure

5 Ultra-quiet



OUTDOOR UNITS



OUTDOOR UNITS

R2-Series/H2i® R2-Series/Y-Series/H2i Y-Series/S-Series / H2i S-Series / W-Series

OUTDOOR UNITS SHOWCASE

R2- AND Y-SERIES



R2-Series Heat Recovery (Standard and High-Efficiency)

72-336
80-378

TURY up to 50 indoor units

72

80



R2-Series H2i® Heat Recovery



72-240
80-270

TURY up to 48 indoor units

72

80



Y-Series Heat Pump (Standard and High-Efficiency)

72-432
80-480

TUHY up to 50 indoor units

72

80



Y-Series H2i® Heat Pump



72-240
80-270

TUHY up to 41 indoor units

72

80



WR2-Series Heat Recovery (Water-Source)

72-336
80-378

TQRY up to 50 indoor units

72

80



WY-Series Heat Pump (Water-Source)

72-360
80-405

TQHY up to 50 indoor units

72

80



S-SERIES (TUMY)

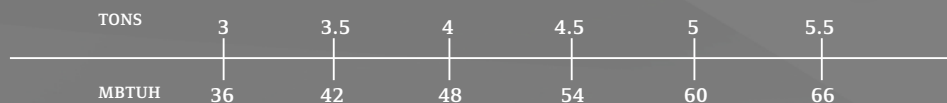

S-Series Heat Pump

36-60
40-66

TUMY up to 12 indoor units

36

60

40

66



S-Series H2i® Heat Pump



36-48
42-54

TUMY up to 12 indoor units

36

48

42

54



CAPACITY RANGE

HEATING COOLING



CITY MULTI® OUTDOOR UNIT OPERATING RANGES

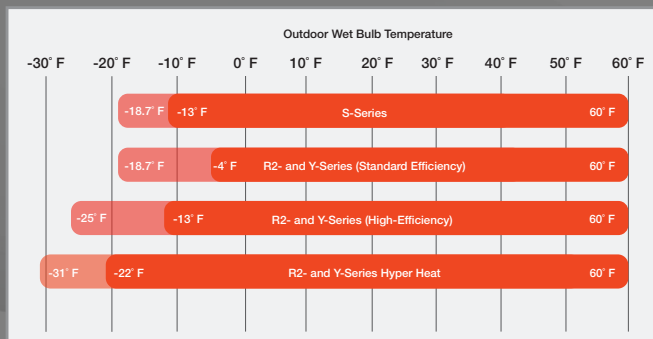
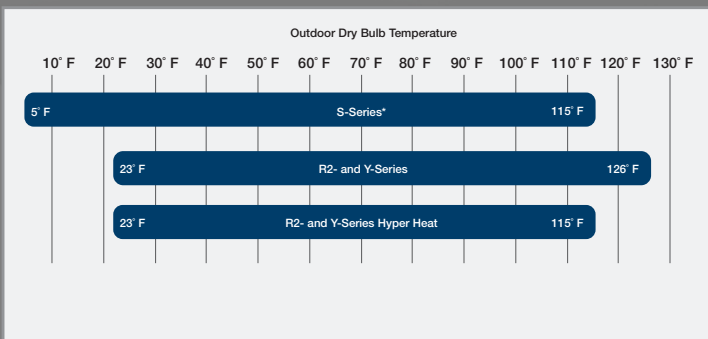

*Low ambient operation may require the use of low ambient accessories.



NEW!

R2-SERIES

N-GENERATION

The industry's first two-pipe heat recovery system that simultaneously cools and heats.

The R2-Series simultaneously cools and heats different zones within a building to provide energy-saving heat recovery operation through the use of the Branch Circuit (BC) Controller.



KEY FEATURES: N-GENERATION

- ▶ Up to a 30% smaller footprint than previous outdoor unit models
- ▶ Expanded vertical piping limits increase by over 130 feet
- ▶ Redesigned main BC Controller features a 14% reduction in height compared to previous models along with a removable drain pan
- ▶ Connect up to 11 sub-BC controllers to one main BC
- ▶ Requires approximately 13% less refrigerant charge than L-Generation
- ▶ Broader range of capacities, with units from 6 to 36 tons
- ▶ Increased energy efficiency with an up to 27% improvement than prior generation units
- ▶ New 4-sided heat exchanger, compressor and fan blade design improve both nominal and seasonal efficiency levels
- ▶ Five air flow settings
- ▶ Unique flat tube aluminum heat exchanger ensures maximum heat transfer, particularly at part-load conditions
- ▶ Improved heating performance, with H2i® liquid injection technology standard on high-efficiency models, provides comfort in any climate
- ▶ Built-in USB port allows for download and storage for up to five days of operational data directly into Maintenance Tool, resulting in simplified troubleshooting and maintenance
- ▶ Ultra-quiet noise levels. Improved compressor and fan design reduces noise output with decibel levels as low as 55 dB(A)

Refrigerant Piping Lengths (Maximum Feet)

Total Length ¹	1,761–3,073
Farthest indoor from outdoor	541 (623 equivalent)
Maximum length between outdoor and single/main BC Controller	360
Maximum length between single/main BC controller & indoor	131–197

Vertical Separation Between Components (Maximum Feet)

Indoor/Outdoor (Outdoor Higher) ³	164
Indoor/Outdoor (Outdoor Lower) ⁴	131
Indoor/BC Controller (Single/Main) ²	49
Indoor/Indoor	98
Main Controller/Sub BC Controller	49

1. Maximum Total Length is dependent on the outdoor unit model and distance between BC Controller.

2. Maximum length between single/main BC Controller and indoor is dependent upon the vertical differential between the single/main BC Controller and the indoor unit.

3. 295' is available depending on model and installation conditions. For more detailed information, contact your local Trane Commercial Sales Office

4. 197' is available depending on model and installation conditions. For more detailed information, contact your local Trane Commercial Sales Office

SIMULTANEOUS OPERATION

CITY MULTI® VRF systems provide simultaneous cooling and heating any time of year. This innovation transfers heat from one zone, normally ejected outside the building, to be used in another zone within the building.

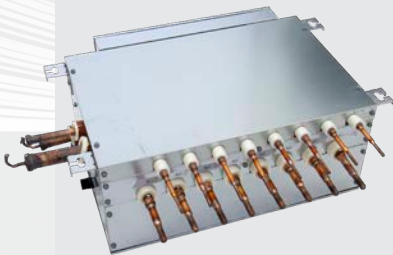
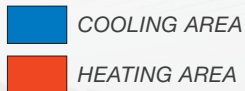
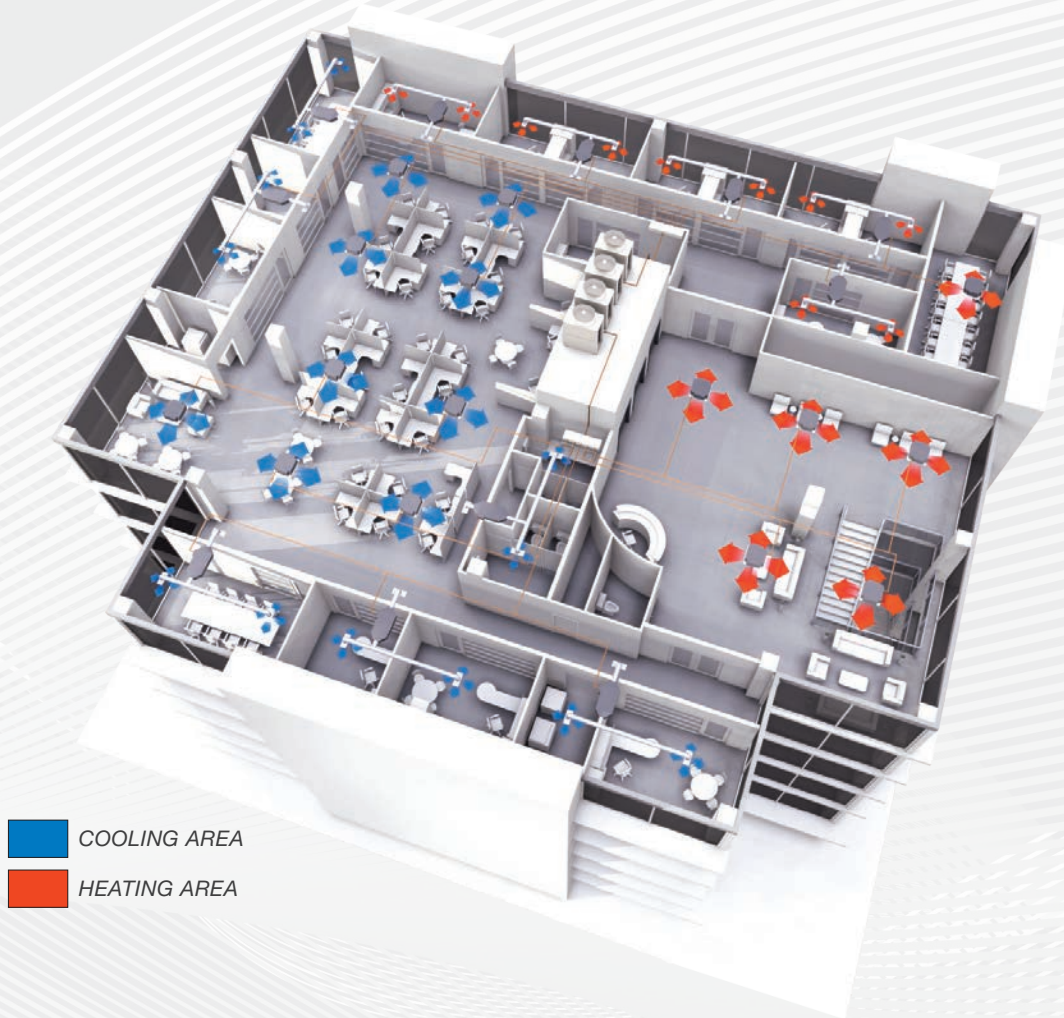

Branch Circuit Controller

The BC Controller is the technological heart of the CITY MULTI R2-Series. It works in unison with the outdoor unit to provide simultaneous cooling and heating, something no other two-pipe system can do.

Single BC Controller:

For systems with up to 120,000 BTUH nominal cooling capacity that require only one BC Controller.

Main BC Controller:

For larger systems that require the use of Sub BC Controllers.

Sub BC Controller:

Used with a Main BC Controller to connect additional indoor units. A maximum of 11 Sub BC Controllers can be connected to one Main BC Controller per system.

THE TWO-PIPE ADVANTAGE

CITY MULTI® heat recovery systems provide simultaneous cooling and heating with just two refrigerant pipes. As the number of indoor units grow, so do the two-pipe installations savings, in terms of connections (refrigerant and electrical) as well as maintenance access.

FEWER CONNECTIONS REQUIRED FOR SIMULTANEOUS OPERATION

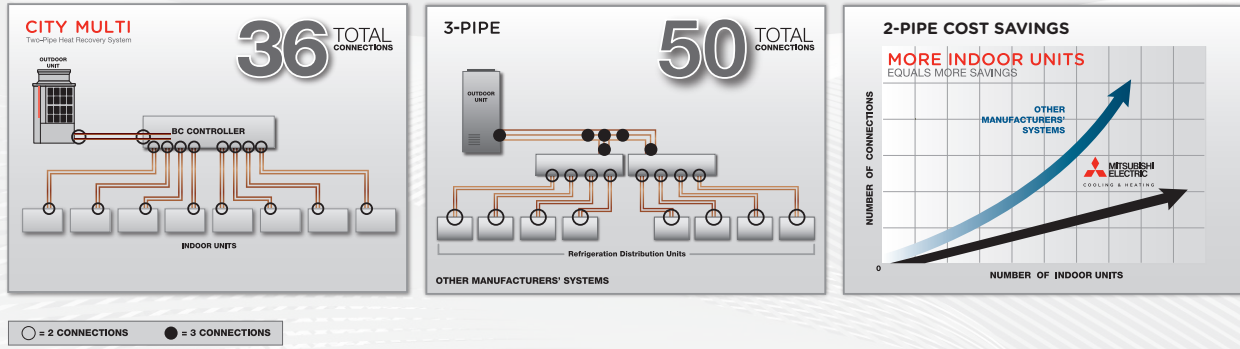

EFFECTIVE ENERGY USAGE

The total applied capacity of the R2-Series system's indoor units can be up to 150% of the capacity of the outdoor units. This is made possible by taking advantage of load diversity and simultaneous cooling and heating operation. CITY MULTI VRF systems can satisfy a significantly higher building load by efficiently distributing the capacity to the outdoor units and indoor units while using much less energy. CITY MULTI systems, in combination with Mitsubishi Electric's Integrated Centralized Control Web configured with optional Energy Allocation software, appropriately allocates the cooling and heating usage among the tenants. The allocation is based on each tenant's usage of comfort control based on the temperature setting on their system controller. Energy Allocation can control up to 2,000 indoor units from a single PC.

MODULAR SCALABILITY

With the Twinning Kit accessory, the modular units easily combine in the field to create a larger capacity system. Only two refrigerant pipes need to be twinned, saving time and materials. Oil and pressure equalization lines aren't needed when combining modules. This also helps to reduce installation cost.

SIMULTANEOUS OPERATING RANGE



Bringing year-round comfort to extreme climates with energy recovery

The Hyper-Heating INVERTER® (H2i) R2-Series simultaneously cools and heats different zones within a building to provide energy saving heat recovery operation. Our 2-pipe H2i R2-Series gives you the flexibility to fit the specific needs of any building and provides reliable cold-climate heating performance.



KEY FEATURES

- ▶ 2-pipe, simultaneous operation for up to 48 zones
- ▶ Available capacities (6, 8, 10, 12, 16, 20 ton)
- ▶ 50%–150% connectible capacity
- ▶ 70% heating capacity at -22° F, up to 85% heating capacity at -13° F and 100% heating capacity at -4° F (6 ton and 8 ton)
- ▶ Improved Hyper-Heating INVERTER® (H2i) technology delivers superior heating performance in extreme climates
- ▶ Introduction of 10 ton single module
- ▶ Provides continuous heating during defrost, improves occupant comfort
- ▶ Uses BC Controllers and headers to provide piping design flexibility and simultaneous operation
- ▶ INVERTER-driven compressor for outstanding performance and optimized energy usage
- ▶ Industry leading performance with lower power requirements
- ▶ Connects to CITY MULTI® indoor units; controlled via CITY MULTI Controls Network (CMCN)

Maximum Refrigerant Piping Lengths (Feet)

Total length (maximum total length is dependent on the outdoor unit model and distance between BC Controller)	1,804–2,460
Farthest indoor from outdoor	541 (623 equivalent)
Maximum length between outdoor & single/main BC Controller	360
Maximum length between single/main BC Controller and indoor	131–197

Vertical Differentials Between Components (Maximum Feet)

Indoor/Outdoor (Outdoor Higher)	164
Indoor/Outdoor (Outdoor Lower)	131
Indoor/BC Controller (Single/Main) (Maximum length between single/main BC Controller and indoor is dependent upon the vertical differential between the single/main BC Controller and the indoor unit)	49
Indoor/Indoor	49
Controller/Sub BC Controller	49

NEW!

N-GENERATION

Two-pipe zoned heat pump system

Y-Series outdoor units are flexible enough to cool or heat up to 50 individual zones, maximizing building design options. The modular unit design features a small footprint and low operating sound.



KEY FEATURES

- ▶ Improved heating performance providing up to 28% improvement compared to previous L generation
- ▶ Flash injection technology built-in as standard (High-efficiency models)
- ▶ Up to 28% IEER improvement compared to L-Generation models
- ▶ HexiCoil™ aluminum flat tube heat exchanger technology, eliminating copper tubing from the coil (High-efficiency tier)
- ▶ Significantly less refrigerant charge required vs. prior models
- ▶ Supports up to 50 indoor units per outdoor unit
- ▶ Optimized refrigerant circuit and component design for improved flow distribution, allowing maximum energy transfer with minimal power input
- ▶ Superior high-ambient cooling performance with guaranteed operation to 126° F
- ▶ Extended 10-year parts and compressor warranty available

HEXICOIL CONDENSER COIL TECHNOLOGY (High-efficiency tier)

- ▶ Optimized cross-sectioned tubed walls ensure maximum heat transfer
- ▶ Zinc-coated for long-term corrosion resistance
- ▶ Unique fin shape and coating provide water shedding capability
- ▶ Capillary tube system provides even fluid distribution

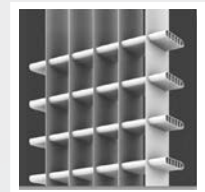

Maximum Refrigerant Piping Lengths (Feet)

Total Length	3,280
Indoor to Outdoor	541
Indoor to First Branch	295

Vertical Differentials Between Units (Maximum Feet)

Indoor/Outdoor (Outdoor Higher) ¹	164
Indoor/Outdoor (Outdoor Lower) ²	131
Indoor/Indoor	98

1. 295' is available depending on model and installation conditions. For more detailed information, contact your local Trane Commercial Sales Office

2. 197' is available depending on model and installation conditions. For more detailed information, contact your local Trane Commercial Sales Office

ULTIMATE IN ZONING

The CITY MULTI® Y-Series uses a two-pipe system with a wide variety of indoor units and individual zone controllers to provide the ultimate zoning system. Headers and T-branches simplify the piping design and provide design freedom for placement of both piping and indoor units. Individual zones are managed by remote controllers placed in each zone or by the centralized controller.

Conference Room Application

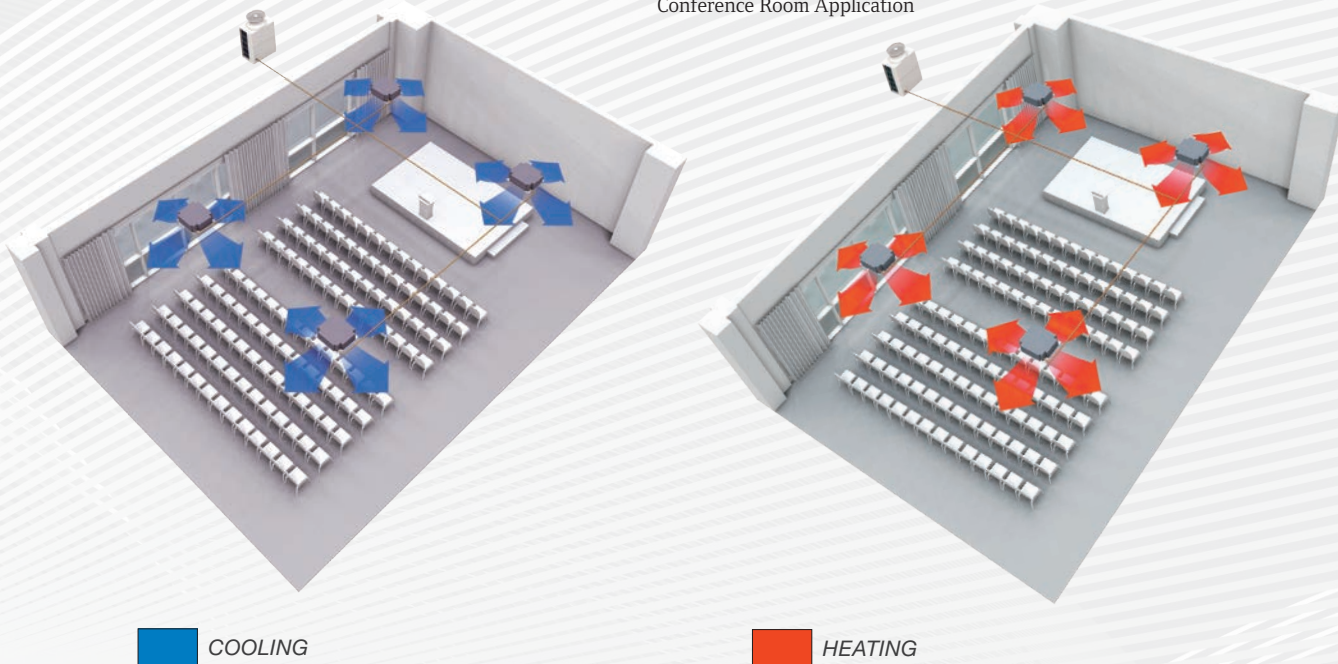

INTELLIGENT ENERGY USAGE

The highly responsive INVERTER technology and customized zone control of the CITY MULTI Y-Series provides year-round savings. In warm summer months, the Y-Series provides exceptional zoned cooling, and in cold winter months, the INVERTER-driven compressor provides outstanding heating performance. CITY MULTI systems, in combination with Mitsubishi Electric's Integrated Centralized Control Web configured with optional Energy Allocation software, appropriately allocates the cooling and heating usage among the tenants. The allocation is based on each tenant's actual usage. Integrated Centralized Control Web can control up to 2,000 indoor units from a single PC.

DESIGN FLEXIBILITY

Flexibility is the key with the CITY MULTI Y-Series. The Y-Series, just like the R2-Series, can condition up to 50 zones. By using T-branches and headers, the Y-Series provides the ultimate in piping design flexibility that is truly simple in application.

NEW!

Bringing year-round comfort to extreme climates with energy recovery

Hyper-Heating INVERTER® (H2i) technology enhances the Y-Series by providing full heating capacity to -4° F outdoor ambient temperature. H2i technology is exclusive to Mitsubishi Electric and is available in select CITY MULTI® VRF units.



KEY FEATURES

- ▶ Heat pump that provides either all-cool or all-heat operation in up to 41 zones
- ▶ Available capacities (6, 8, 10, 12, 16, 20 ton)
- ▶ 50%–130% connectible capacity
- ▶ Extreme performance provides up to 100% heating capacity at - 4° F, up to 85% heating capacity at -13° F, and up to 70% heating capacity at -22° F
- ▶ Uses T-branches and headers to provide piping design flexibility
- ▶ INVERTER-driven compressor for outstanding performance and optimized energy usage
- ▶ Industry leading performance with lower power requirements
- ▶ Connects to CITY MULTI indoor units; controlled via CITY MULTI Controls Network (CMCN)

Maximum Refrigerant Piping Lengths (Feet)

Total Length	984
Indoor to Outdoor	492
Indoor to First Branch	131

Vertical Differentials Between Units (Maximum Feet)

Indoor/Outdoor (Outdoor Higher)	164
Indoor/Outdoor (Outdoor Lower)	131
Indoor/Indoor	49

EXTREME HEATING PERFORMANCE

With its expanded heating capabilities, the CITY MULTI® H2i® R2- and Y-Series provides year-round comfort, even in extreme climates.

- ▶ At -4° F outdoor temperature, the H2i system can provide 100% of rated heating capacity
- ▶ At -13° F outdoor temperature, the system can provide up to 85% heating capacity
- ▶ At -22° F, the system can provide up to 70% heating capacity

UNEQUALED COMFORT

The patented flash injection process cools the compressor, allowing higher speeds at a lower outdoor temperature without overheating. This also allows the system to maintain indoor coil temperatures providing phenomenal heating performance at low temperatures. The Hyper-Heating INVERTER® combines the ultimate in application flexibility and powerful conditioning capabilities to deliver personalized comfort control to multiple zones of a commercial or institutional building. The outdoor units deliver full-sized performance from a compact, space-saving design for ease of transportation and installation. The INVERTER-driven scroll compressor delivers the precise amount of comfort to the zones as required.

HYPER-HEATING INVERTER VS. OTHERS

(72,000 BTUH, 70° F W.B. entering Indoor Unit)

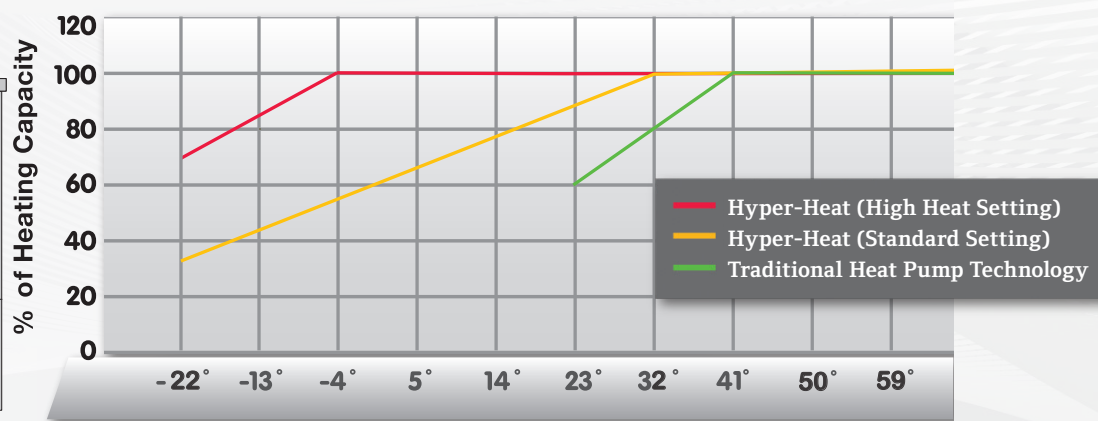
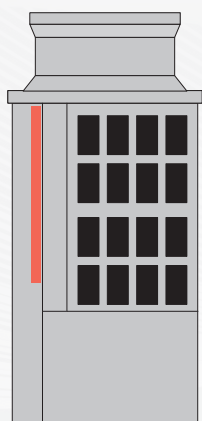

Solutions for light commercial and large residential applications

The CITY MULTI® S-Series (TUMY) is a single-phase heat pump system ideal for light commercial or large residential applications. Featuring best-in-class efficiency ratings and ENERGY STAR® qualification, TUMY systems are designed to deliver operational cost savings and long-time performance to a homeowner or building owner. It uses the CITY MULTI Controls Network (CMCN) to cool or heat up to 12 individual zones with a choice of indoor unit styles.



KEY FEATURES

- ▶ Single-phase 208/230V operation allows use in residential and light commercial applications
- ▶ Systems available from 36,000–60,000 BTUH
- ▶ All models are Energy Star® qualified
- ▶ SEER rating improvement of 8% (average vs. prior models)
- ▶ HSPF rating improvement of 3% (average vs. prior models)
- ▶ Blue-fin condenser coating standard on all models
- ▶ Extended heating operating range down to -18° F
- ▶ Extended cooling operating range down to 5° F
- ▶ Connects up to 12 indoor units

Maximum Refrigerant Piping Lengths (Feet)	
Total Length	984 ¹
Indoor to Outdoor	492 ²
Indoor to First Branch	98
Vertical Differentials Between Units (Maximum Feet)	
Indoor/Outdoor (Outdoor Higher)	164
Indoor/Outdoor (Outdoor Lower)	131
Indoor/Indoor	49

1. Applies to P36 and P48 models only. P60 is 492'.

2. Applies to P36 and P48 models only. P60 is 262'.

H2i® S-SERIES (TUMY)

Introducing the expansion of the S-Series (TUMY) outdoor unit lineup to include Hyper-Heating INVERTER® (H2i®) technology

Part of the CITY MULTI® family, the H2i® TUMY is a single-phase heat pump ideal for light commercial applications including banks, churches, schools, server rooms, retail centers and more.



KEY FEATURES: S-SERIES

- ▶ Available in 36,000 and 48,000 BTUH capacities
- ▶ 100% heating capacity at 1° F
- ▶ 78% heating capacity down to -13°F, utilizing flash injection technology
- ▶ Models are Energy Star® qualified
- ▶ Base Pan Heater standard

**Low ambient operation requires the use of low ambient accessories such as a WB-PA3 Wind Baffle.*



Modular heat pump systems that combine the convenience of water source with VRF technology

W-Series units are easily installed indoors, which means that system performance efficiency is independent of outdoor ambient temperatures. W-Series includes WR2 models for simultaneous cooling and heating, and WY models for independent cooling and heating operation.



KEY FEATURES

- ▶ Single modules up to 20 tons with the ability to combine single modules for systems up to 30 tons
- ▶ 208/230V, 3-Phase, 60 Hz and 460V, 3-Phase, 60 Hz options
- ▶ 0-10V output signal to modulate water flow for compliance with energy codes
- ▶ Enhanced water-side heat exchanger design for improved efficiency and reduced risk of clogging
- ▶ Designed for closed water loops
- ▶ Connects to CITY MULTI® indoor units and controlled via CITY MULTI Controls Network (CMCN)
- ▶ Stack multiple units on a field-supplied rack to take advantage of vertical space when available
- ▶ Extended 10-year parts and compressor warranty available
- ▶ Unlike previous versions, water flow can be stopped while the unit is in a thermo-off state, saving on pump energy consumption. For twinned systems, both modules must be thermo-off to stop water flow
- ▶ A1 water-source units feature the Variable Evaporating Temperature (VET) technology enables the W-Series unit to raise the target evaporation temperature based on the difference between set point and return air temperature, saving energy

Benefits

CITY MULTI SYSTEMS AND GEOTHERMAL APPLICATIONS

CITY MULTI water-source systems, used in geothermal and other types of applications, work by taking heat or rejecting heat from/to the ground. Closed loop systems accomplish this by circulating water through a series of wells or loops that are installed in the ground, turning the ground into a large heat exchanger. Because the ground remains relatively unaffected by outdoor ambient temperatures, the loop runs at temperatures lower than ambient temperatures throughout the cooling season and higher than ambient temperatures throughout the heating season.

DOUBLE-HEAT RECOVERY

The double-heat recovery feature of the WR2-Series helps recover energy that would normally be rejected to the condensing water loop. First, within the system, energy is absorbed in units providing cooling. The energy is redirected by refrigerant to units that are in heating mode. Secondly, energy can be recovered between systems through the water loop.

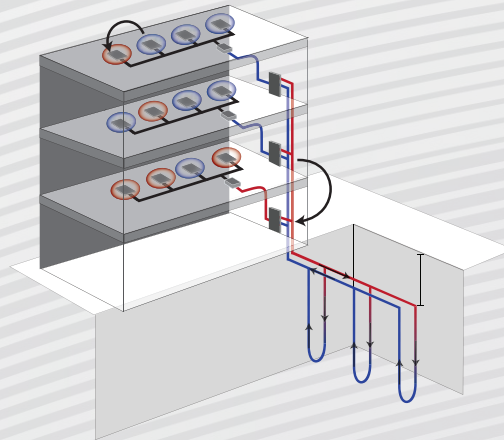

EXTENDED TEMPERATURE RANGE

WR2- and WY-Series CITY MULTI® water-source units can handle entering water temperatures down to 23° F (with the addition of glycol to the condenser water loop) in both heating and cooling mode allowing more possibilities for geothermal applications. Coupling the water-source units with a geothermal loop will not only provide the benefit of higher efficiencies by using a lower entering water temperature but will also provide all the benefit of an INVERTER-driven CITY MULTI system.

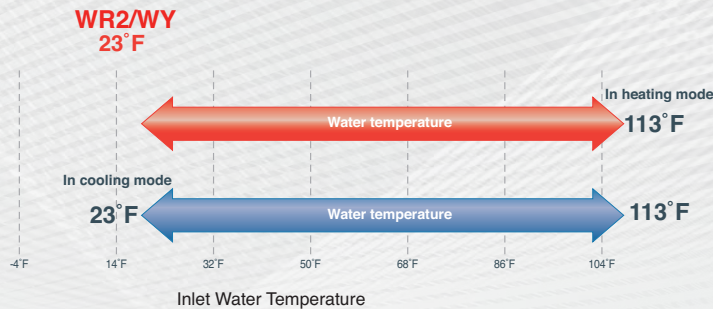

VARIABLE EVAPORATING TEMPERATURE (VET)

Variable Evaporating Temperature (VET) technology enables the outdoor unit to raise the target evaporation temperature based on the difference between set point and return air temperature.

- ▶ Once all indoor units are within 1.8° F of set point, the target evaporating temperature will rise in a linear fashion the closer the indoor unit gets to set point.
- ▶ Four levels of VET are available (32° F, 37° F, 41° F and 43° F), offering energy efficiency improvements of 25%–45%.

ELECTRONIC PRESSURE INDEPENDENT VALVE (ePIV)

- ▶ The ePIV receives a 0–10V input signal from the outdoor unit. This allows water flow to vary from nominal down to minimum, as demand is reduced
- ▶ The valve eliminates power input penalties and capacity loss due to lower design flow at full load operation, while saving on pump energy at reduced load conditions
- ▶ The valve contains a built-in ultrasonic flow meter with direct feedback into the valve actuator. This eliminates the balancing valve, along with labor to install it, for minimum and maximum flow and provides an integral flow switch function

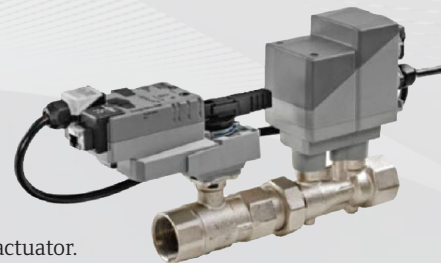

LOW AMBIENT COOLING KIT

Full cooling performance in extreme conditions

The specially designed wind deflectors will block unwanted wind that could impede operation and will allow full airflow when required at higher ambient temperatures or in heating mode. The assembly also provides a more efficient defrost cycle when the unit is operating in heating mode. Complete Low Ambient Kit requires hood with control damper assembly and wind deflectors.



PATENTED TECHNOLOGY

Low ambient hood (LAHK-1 and LAHK-2), Side Deflector (SWDK1), and Rear Deflector (RWDK1).

KEY FEATURES

Allows system to operate at 100% cooling capacity at reduced outdoor temperatures:

- ▶ Y-Series Outdoor Units (down to -10° F DB Outdoor Temp.)
- ▶ R2-Series (includes H2i® R2-Series) Outdoor Units (down to -10° F DB Outdoor Temp.)

ADDITIONAL FEATURES

- ▶ Hood and wind deflectors constructed of 20 gauge hot-dipped galvanized G-90 steel
- ▶ Heavy-duty polyester-based powder paint finish
- ▶ Designed to work with both 208/230 and 460V 3-phase units
- ▶ NEMA 4 control box protects electrical components from the elements
- ▶ Kit easily connects to outdoor unit with plug-in electrical connections
- ▶ Wind deflectors easily install in place of existing wire guard

APPLYING TO MULTIPLE OUTDOOR UNITS

For outdoor units with multiple modules, a minimum 1-3/16" separation between the modules is recommended. If modules are placed more than 15" apart, more than one set of side wind deflectors may be needed. For multiple units or module sets placed in a row, only one side wind deflector is needed for each of the outside module coil surfaces.

COLD WEATHER SOLUTIONS



Low Ambient Cooling (LAHK Series)

The specially designed wind deflectors block unwanted wind that could impede operation and allow full airflow when required at higher ambient temperatures or in heating mode. The wind deflectors also provide a more efficient defrost cycle when the unit is operating in heating mode. The complete Low Ambient Kit requires a hood with a control damper assembly and wind deflectors. With the addition of wind deflectors, CITY MULTI® Y-Series and R2-Series outdoor units feature 100% cooling capacity at outdoor temperatures down to -10° F. The wind deflector kit easily installs in the place of the existing wire guard, and the hood connects to the outdoor unit with plug-in electrical connections.



Hail/Snow Guards (SGN Series)

Designed to protect the outdoor unit coil surfaces from hail damage or snow buildup in severe climates. Made of 20-gauge, hot-dipped galvanized G-90 steel, the hail/snow guards feature a heavy-duty polyester-based powder paint finish to match the outdoor units. Using existing wire guard fasteners, the hail/snow guards are easily installed to the sides and rear of the unit in just minutes.

SGK-Series is compatible with N-Generation.



Hail/Snow Hoods (SHN Series)

Hail/snow hoods are made to the same specifications as the hail/snow guards, and protect the outdoor unit fan guard from hail damage and snow buildup in severe climates. Using existing wire guard fasteners, the hail/snow hoods are easily installed to the sides and rear of the unit in just minutes. Hail/snow hoods are sold separately.

Base Pan Heaters

Trane®/ Mitsubishi Electric base pan heaters feature a heating coil controlled by the CITY MULTI® outdoor unit which prevents ice buildup. The base pan heater is ideal for low temperature, high humidity environments where the outdoor unit will be operating in heating mode for an extended period of time. A complete base pan heater order should include a relay box, the heating element(s), required mounting brackets, and all other associated items required for installation.

Note: Snow hoods and side/rear snow guards are also recommended for installations with base pan heaters.

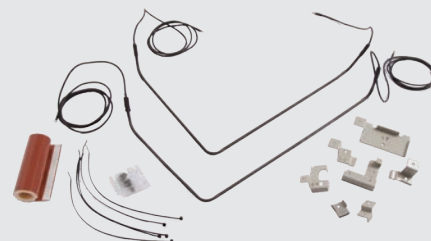

BASE PAN HEATER CONTROL BOX



Supplemental Base Pan Heaters

Available for K & L-Generation Outdoor Units, Supplemental Base Pan Heaters provide additional heat to keep Base Pans clear of ice buildup in extreme weather conditions.

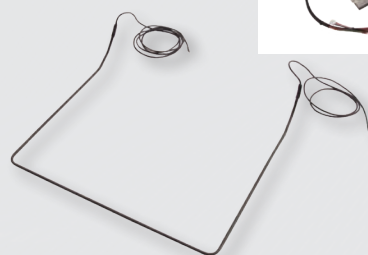

Cold Weather Stands and Supports

Trane®/ Mitsubishi Electric features multiple configurations of stands and supports for Nv-Series, P-Series, and CITY MULTI outdoor units.

The sturdy stands and supports are designed to keep the outdoor unit above or off the ground and away from snow drifts in cold weather climates.

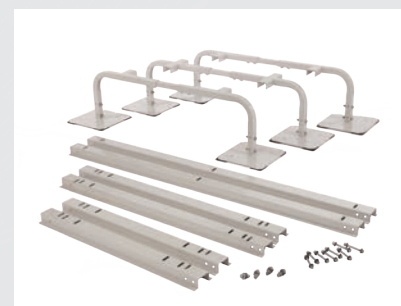

SuperStands

SuperStands provide secure mounting support and height above ground to keep CITY MULTI outdoor units out of normal snow accumulations. Available in 12", 18", and 24" leg heights for varying mounting options. The stands lock together to make one continuous interlocked stand for almost any number of outdoor units.

- ▶ Rubber roof friendly
- ▶ Adjustable height in ¼" and ½" increments.
- ▶ U-bars made from 11 gauge steel square tubing
- ▶ Available leg heights: 12", 18", and 24"

Outdoor unit must be mounted at least 12" off the ground or 12" above the highest average snow depth, whichever is greater. The outdoor unit may require additional mounting restraints depending on the mounting location.



LINEAR EXPANSION VALVE (LEV) KIT

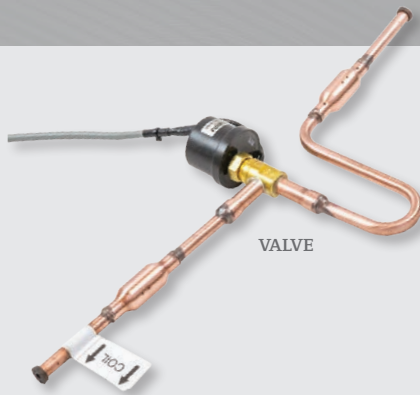

- ▶ The LEV kit is an interface to connect CITY MULTI® outdoor units to air handlers produced by other manufacturers. These air handlers can be used with or without CITY MULTI indoor units
- ▶ The LEV kit is used to control room temperature or with a Dedicated Outdoor Air System (DOAS) for discharge temperature control
- ▶ The kit can be used for 0–10 VDC set point control from other devices
- ▶ The kit can be used with all CITY MULTI control options, including CN105 connections (return air temperature control only)

LEV Assembly Model*	Capacity Code Setting [Ton]	Design Capacity Range [BTUH]
LEV PAC-LV24AC-1	0.5, 0.7, 1, 1.25, 1.5, 2	4,800–24,000
LEV PAC-LV48AC-1	2.25, 2.5, 3, 4	24,000–48,000
LEV PAC-LV60AC-1	4.5, 5	48,000–60,000
LEV PAC-LV96AC-1	6, 8	60,000–96,000
LEV PAC-LV120AC-1	10	96,000–120,000
LEV PAC-LV96AC-1 (x2)	12, 14, 16	120,000–192,000
LEV PAC-LV120AC-1 (x2)	18, 20	192,000–240,000

*Control box assembly required (PAC-AH001-1)

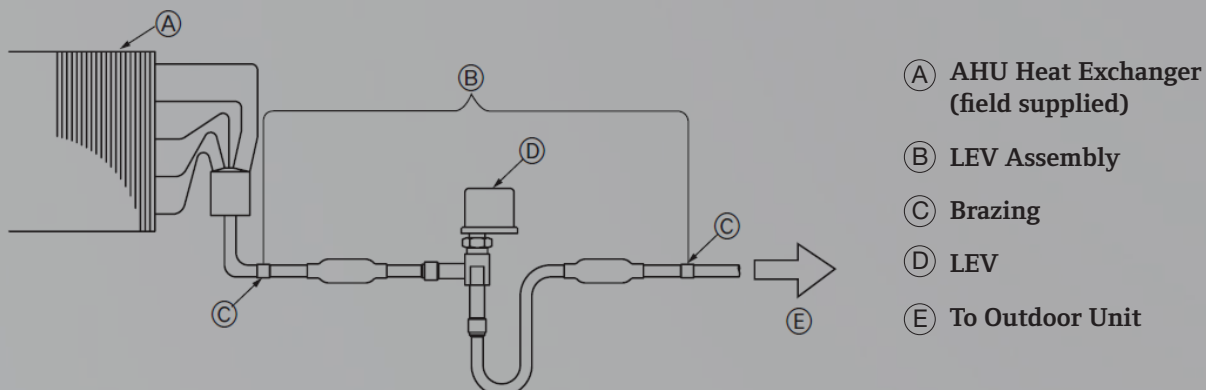

S-SERIES ACCESSORIES

S-Series accessories feature the latest in high quality, durable products designed to complement outdoor units and to maintain peak performance and with limited maintenance.

Vertical Air Deflector

The S-Series air deflector changes the direction of the discharged air. This permits multiple outdoor units to be positioned closer together in applications with limited space.



Front Wind Baffle

The specifically designed S-Series front wind baffles block unwanted wind that could impede operation by preventing the fan from counter-rotating in windy conditions. The addition of a front wind baffle to the cabinet of the outdoor unit also extends the cooling capacity. This component is constructed to be durable and low maintenance.



Base Pan Heater

S-Series base pan heaters feature a heating coil controlled by the outdoor unit which prevents ice buildup. The base pan heater is ideal for low temperature, high humidity environments where the outdoor unit will be operating in heating mode for an extended period of time.



Air Outlet Guide

The air outlet guide is used to force air out of the outdoor unit, either upward, downward or sideways (to the left or to the right). It can be used to prevent the outdoor unit from short cycling the exhaust air. It also enables the outdoor unit to be mounted closer to a wall or other outdoor units.



A photograph of a classroom. On the left, there is a large whiteboard with colorful drawings of people. In the center, a large window with green curtains looks out onto a brick building. The room is furnished with several wooden desks and chairs. The ceiling has a recessed lighting fixture. A semi-transparent red banner is overlaid across the middle of the image, containing text.

INDOOR UNITS

*TPKFY Wall-mounted / TPLFY Ceiling Cassette / TPMFY Ceiling Cassette /
TPCFY Ceiling-suspended / TPEFY Ceiling-concealed Ducted /
TPFFY Floor-standing / TPV FY Multi-position*











INDOOR UNITS



INDOOR UNITS SHOWCASE

Complete Building Comfort Solutions

All models feature quiet operation, easy maintenance, and the ultimate in personalized comfort control. The chart below gives the capacity size for each model.

Capacity Code	Nominal BTUH													
	5,000	6,000	8,000	12,000	15,000	18,000	24,000	27,000	30,000	36,000	48,000	54,000	72,000	96,000
Wall-mounted TPKFYP-(BM, HM, KM) 		●	●	●	●	●	●		●					
Ceiling Cassette (4-way) TPLFYP-EM 		●	●	●	●	●	●		●	●	●			
Ceiling Cassette (4-way) TPLFYP-FM 	●		●	●	●	●								
Ceiling Cassette (1-way) TPMFYP-BM 		●	●	●	●									
Ceiling-suspended TPCFYP-KM 					●		●		●	●				
Ceiling-concealed (Ducted Low-Profile) TPEFYP-MS 		●	●	●	●	●	●							
Ceiling-concealed (Ducted Medium Static) TPEFYP-MA 		●	●	●	●	●	●	●	●	●	●	●		
Ceiling-concealed (Ducted High-Static) TPEFYP-MH 					●	●	●	●	●	●	●	●	●	●
Floor-standing (Exposed/ Concealed) TPFFYP-(CS, RE) 		●	●	●	●	●	●							
Multi-position TPVFYP-AM 				●		●	●		●	●	●	●		
TPWFYP-(AU, BU) 										●			●	-AU only

Elegant design and compact dimensions

Whatever the size or shape of your room, there's a TPKFYP wall-mounted unit that is just right for you. TPKFYP units mount high on the wall and blend beautifully into any space. Perfect for hotels, assisted living facilities, offices, residences and other applications where wall space is available.



KEY FEATURES

- ▶ Ranges from 6,000 to 30,000 BTUH
- ▶ Compact, lightweight and features a built-in wireless sensor for use with an optional wireless remote controller
- ▶ Extremely quiet: as low as 32 dB(A)
- ▶ Multiple fan speed settings.
- ▶ Multiple vane settings and swing setting adjust airflow in vertical directions
- ▶ Front panel opens easily—no tools are needed to gain access to the filter
- ▶ Refrigerant and drain piping can be connected from the rear, right, base, or left of the unit
- ▶ Condensate pump systems are available when gravity drainage is not available

Benefits

EASY FILTER CLEANING

The front grille hinges open easily—no tools are needed to gain quick access to the filter. The filter can be removed and cleaned as needed.

QUIET OPERATION

The unit incorporates a random-pitch fan to assure quiet operation. The optimal design of the airflow passage features a small fan diameter to allow for a compact installation. Thanks to practical casing configuration, airflow generated by the fan is uniformly distributed.

SUPERIOR AIR DISTRIBUTION

A user-selectable vane swing setting with the Smart ME and Simple MA remote controllers enhances air distribution in the conditioned space.

FLEXIBLE INSTALLATION

Refrigerant and drain piping can be connected from the rear, right, base, or left of the unit, providing much greater flexibility for piping and selecting an installation site.

TPLFYP (Four-way Ceiling Cassette)

Bringing Adjustable airflow to meet your every need

The TPLFYP-Series four-way ceiling cassette provides exceptional performance and air coverage. Two styles are available: the TPLFYP-FM140A and TPLFYP-EM140A. Both models can be accessorized with installation trim panels (TPLFYP-ITP1 and TPLFYP-ITP2) to ensure a seamless integration into suspended ceilings.

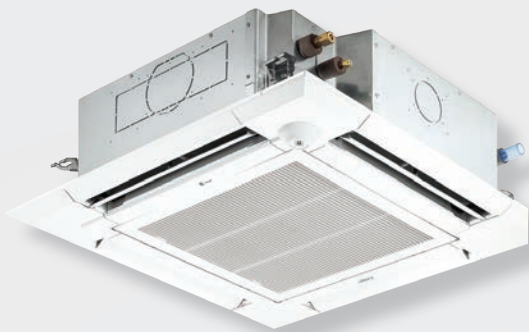

TPLFYP-EM140A

KEY FEATURES

- ▶ 33" x 33" cabinet size
- ▶ Capacity range of 6,000 to 48,000 BTUH
- ▶ Sound levels as low as 27 dB(A)
- ▶ Ventilation air connection (Second connection found in multifunction casement)
- ▶ High-efficiency filter option (MERV-10 requires multifunction casement)
- ▶ Branch ducting capability
- ▶ Four speed fan settings
- ▶ Integrated condensate lift mechanism to provide up to 33-7/16" of lift

TPLFYP-FM140A

KEY FEATURES

- ▶ 22" x 22" cabinet size to fit in standard T-grid ceiling
- ▶ Capacity range of 5,000 to 18,000 BTUH
- ▶ Sound levels as low as 29 dB(A)
- ▶ Ventilation air connection
- ▶ Four-speed fan settings
- ▶ Integrated condensate lift mechanism to provide up to 19-11/16" of lift



HIGH PERFORMANCE AND VERSATILITY

The four-way ceiling cassette is compact and recesses easily into a ceiling space, so all you see is an attractive flush-mounted grille. The TPLFYP-EM140A has a unit height of only 10-3/16" or 11-3/4", depending on the model. At 8-3/16" in height and 22-7/16" x 22-7/16" width, the TPLFYP-FM140A makes satisfying even the tightest of ceiling installations a possibility.

QUIET OPERATION

This powerful indoor unit is whisper-quiet, down to 27 dB(A) for the TPLFYP-EM140A and 29 dB(A) for the TPLFYP-FM140A.

CUSTOMIZE THE AIRFLOW PATTERN TO MEET YOUR NEEDS

The different airflow options provide the best solution for a variety of room layouts and air-conditioning requirements. For extra versatility, you can select up to 72 airflow patterns with two-, three-, or four-way airflow.

BUILT-IN CONDENSATE LIFT MECHANISM

The drain piping of the TPLFYP-EM140A can be positioned anywhere up to 33-7/16" from the ceiling's surface, allowing for long piping and versatility. The TPLFYP-FM140A model has a built-in pump that lifts condensate 30" from the ceiling's surface. The unit recognizes if there is a pump failure and safeguards against leaks.

CORNER-POCKET DESIGN SIMPLIFIES MAINTENANCE AND INSTALLATION

TPLFYP-EM140A allows access through the pockets equipped on each of four corners of the grille to complete installation, maintenance work, and height adjustment.

EASY MAINTENANCE, LONG-LIFE FILTER

The washable filter provides about 2,500 hours of use in a normal office environment before cleaning is needed.

4-, 3-, OR 2-WAY AIRFLOW

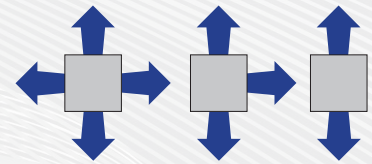

FIXED AIRFLOW DIRECTION PER VANE

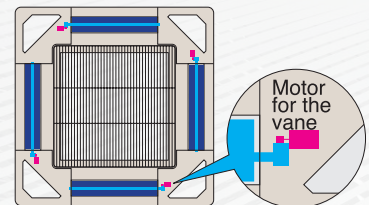

INDEPENDENT VANE MOTOR CONTROL

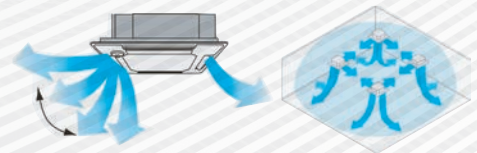

i-see Sensor



The 3D i-see Sensor™ detects the number of occupants in a room and adjusts the temperature accordingly, making automatic energy-saving operation possible in places where the number of occupants frequently changes. Additionally, when the area is continuously unoccupied, the system switches to an enhanced power-saving mode.

- ▶ Detects occupant location
- ▶ Detects size, temperature, and movement of occupants (heat source). Once an occupant is detected, the angle of the indoor unit's vane(s) is automatically adjusted. Each vane can be independently set to "Direct Airflow" or "Indirect Airflow" according to user preference
- ▶ Highly accurate temperature detection
- ▶ The sensor can detect 1,856 points of surface temperature, rotating a full 360° in 3-minute intervals
 - This is a significant improvement over the previous version of the i-see Sensor, which had a single element and did not detect room occupants
- ▶ Room occupancy energy-saving mode
 - When the occupancy rate is approximately 30%, energy consumption is reduced by offsetting the temperature by $\pm 2^{\circ}$ F
- ▶ No occupancy energy-saving mode
 - When the 3D i-see Sensor detects that no one is in the room, and 60 minutes have elapsed, the room temperature is offset by $\pm 4^{\circ}$ F
- ▶ No occupancy Auto-OFF mode
 - When the room remains unoccupied for a user specified period of time, the indoor unit turns off automatically, providing even greater energy savings. The time period can be set, in 10-minute intervals, from 60 to 180 minutes

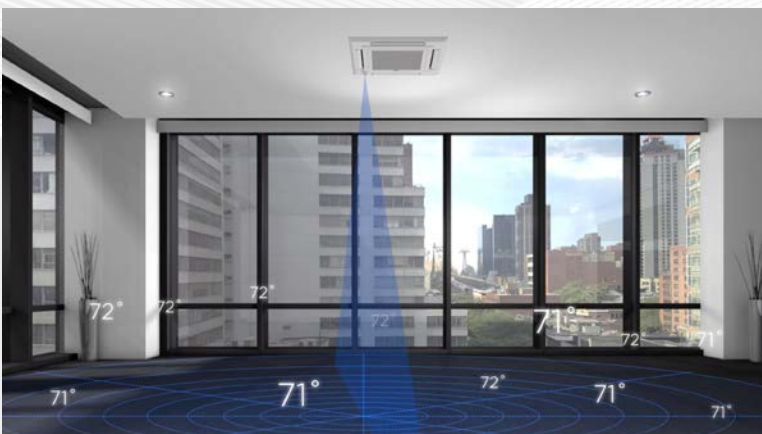

Compact and lightweight, perfect for office spaces with windows

The TPMFYF model is a ductless, one-way, ceiling cassette that moves air in one direction, and has the capability of introducing ventilation air. The TPMFYF can be accessorized with an installation trim panel (TPMFYP-ITP1) to ensure a seamless integration into suspended ceilings.



KEY FEATURES

- ▶ The TPMFYF is available in 6,000, 8,000, 12,000 and 15,000 BTUH
- ▶ Standardized cabinet size for all models: 31-31/32"
- ▶ Airflow control technology operates as low as 27 dB(A) for industry-leading quiet performance
- ▶ Integrated condensate lift mechanism to provide up to 23-5/8" of lift
- ▶ Full unit access through front cover panel

Benefits

QUIET OPERATION

Specialized airflow control technology operates as low as 27 dB(A) for industry-leading sound performance.

BUILT-IN CONDENSATE LIFT MECHANISM

The drain pipe can be extended anywhere up to 23-5/8" above the ceiling's surface.

EASY INSTALLATION AND MAINTENANCE

TPMFYP body size has been standardized for all models at 31-31/32" for easier installation. With a height of only 9-1/16", the profile is one of the smallest of all CITY MULTI ceiling models. This unit is one of the lightest available with a weight of only 31 pounds for the main unit and seven pounds for the panel.

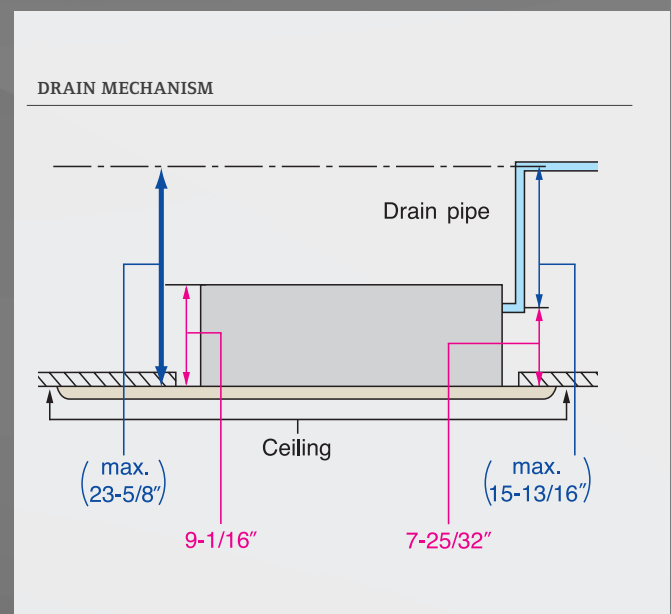

TPCFYP (Ceiling-suspended)

Compact design ideal for classrooms, restaurants and stores

The TPCFYP model features powerful air throw to cover entire spaces quietly and efficiently.



KEY FEATURES

- ▶ Available in 15,000, 24,000, 30,000, and 36,000 BTUH capacities
- ▶ Auto-vane and wide-range outlet provides uniformly distributed conditioned air to all corners of the room
- ▶ Four-speed fan settings
- ▶ Accessory filters are available to increase filtration effectiveness
- ▶ Optional pump kit is available for condensate removal

Benefits

POWERFUL PERFORMANCE

The easy-to-install, ceiling-suspended unit delivers enough cold or hot air to make any space more comfortable. Manually adjusted, oversized swing louvers direct the airflow left or right, covering the entire space quietly and efficiently.

The i-see Sensor™ ACCESSORY

This amazing technology constantly monitors and adjusts temperatures for maximum comfort and efficiency.

- ▶ Measures infrared rays generated from surrounding walls and surface angles
- ▶ Rotates 90 degrees in five-second intervals
- ▶ Efficiently adjusts temperatures to ideal comfort levels for occupants

QUIET, EFFICIENT AIRFLOW

Appropriate airflow can be selected to enhance space conditioning efficiency and comfort while operating at a low sound level. TPCFYP's auto-vane and wide-range outlet swings the conditioned air and distributes it uniformly to all corners of the room.

EASY INSTALL

The TPCFYP's direct suspension allows installation on most ceiling surfaces quickly and securely using only suspension bolts and the durable attachment fixture. An optional pump kit is available to dispose of condensate.

Flexible design allows elegant interior layout

The TPEFYP models are high-performance, ceiling-concealed, ducted indoor units. An excellent choice for office buildings, schools, hotels, assisted-living facilities and other applications where ceiling space is available.



LOW PROFILE (TPEFYP-MS)

- ▶ Provides up to 0.2" external static pressure
- ▶ Extremely quiet, with sound ratings as low as 26 dB(A)
- ▶ Capacities range from 6,000 to 24,000 BTUH
- ▶ Integrated condensate lift mechanism to provide up to 21-11/16" of lift

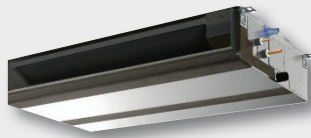

MEDIUM STATIC (TPEFYP-MA)

- ▶ Provides up to 0.6" external static pressure
- ▶ Extremely quiet, with sound ratings as low as 26 dB(A)
- ▶ Capacities range from 6,000 to 54,000 BTUH
- ▶ Integrated condensate lift mechanism to provide up to 27-9/16" of lift



HIGH STATIC (TPEFYP-MH)

- ▶ Provides up to 1.00" external static pressure
- ▶ Extremely quiet, with sound ratings as low as 36 dB(A)
- ▶ Capacities range from 15,000 to 96,000 BTUH
- ▶ Integrated condensate lift mechanism to provide up to 27-9/16" of lift
(Note: Not applicable to P72 and P96 models)

KEY FEATURES

- ▶ External static pressure settings are adjustable to meet varying application conditions
- ▶ Choice of fan speed settings
- ▶ Side access to control panel
- ▶ Integrated condensate lift mechanism (low-static, mid-static and TPEFYP-MH models)

CHOICE OF EXTERNAL STATIC PRESSURE

Additional external static pressure capacity provides flexibility for duct extension, branching, and air outlet configuration. The factory setting can be field-adjusted to match the installed ductwork for TPEFY indoor units.

The TPEFY indoor unit is available in a low-profile option with up to 0.20" W.G., medium static indoor unit up to 0.6 W.G. and a high-static option for up to 1.00" W.G.

QUIET OPERATION

The specially designed centrifugal fan provides exceptionally quiet operation, even at high operating speeds.

OPERATING SOUND RANGE

TPEFY-MA		P06	P08	P12	P15	P18	P24	P27	P30	P36	P48	P54	
Sound Level dB(A)	Fan Speed Low-High	26-29		28-34		28-35 29-36		30-38		32-41		35-44 36-45	
TPEFY-MS		P06	P08	P12	P15	P18	P24						
Sound Level dB(A)	Fan Speed Low-High	22-28	23-30	23-35	28-33	30-37	30-40						
TPEFY-MH		P15	P18	P24	P27	P30	P36	P48	P54	P72	P96		
Sound Level dB(A)	Fan Speed Low-High	34-39		36-41		35-41 38-43		38-44		36-43 39-46			

BUILT-IN CONDENSATE LIFT MECHANISM

The drain piping can be positioned anywhere up to 21-11/16" for TPEFY-MS or 27-9/16" for TPEFY-MA and TPEFY-MH. from the ceiling's surface, allowing for long piping and versatility. A built-in safety switch halts operation if the pump experiences a problem or the drain becomes clogged, ensuring no water leaks occur.

COMPACT OPTIONS (TPEFY-MS)

The TPEFY-MS model is very compact, with a height of 7-7/8". Standard features include brazed refrigerant connections, rear air return, and auto fan mode. The unit operates as low as 22 dB(A), and the control panel is located on the opposite side from other ducted models. This unit is an ideal choice for guest rooms in hotels, dormitories, assisted living centers or any application with tight vertical clearances and minimal duct work.

Designed for CITY MULTI® Ceiling-concealed Ducted Indoor Units

Low-Profile FBL1 boxes include 1"-thick pleated MERV 8 filter(s).

Medium-Static FBM2 boxes include 2"-thick pleated MERV 13 filter(s).

High-Static FBH2 boxes include 4"-thick pleated MERV 13 filter(s).

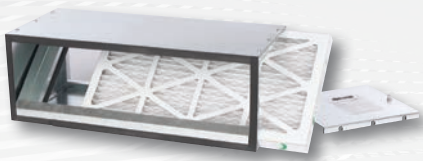

KEY FEATURES

- ▶ Rated Class 2 under UL Standard 900
- ▶ Cabinet is constructed of non-insulated 20 gauge G-60 galvanized steel
- ▶ Foam gasket provides airtight connection to indoor unit and access door
- ▶ Return connection in rear easily field converted to bottom

Part Number	Used on CITY MULTI Models	Filters Included	Net Weight (lbs.)
FBL1-1	TPEFYP-006, 008, 012-MS	(1) – 13" x 25" x 1"	12
FBL1-2	TPEFYP-015, 018-MS	(1) – 12" x 20" x 1" (1) – 12" x 14" x 1"	15
FBL1-3	TPEFYP-024-MS	(3) – 12" x 20" x 1"	18

Part Number	Used on CITY MULTI Models	Filters Included	Net Weight (lbs.)
FBM2-1	TPEFYP-006, 008, 012-MA	(1) – 14" x 25" x 2"	20
FBM2-2	TPEFYP-015, 018-MA	(1) – 14" x 20" x 2" (1) – 14" x 14" x 2"	26
FBM2-3	TPEFYP-024, 027, 030-MA	(2) – 14" x 20" x 2"	32
FBM2-4	TPEFYP-036, 048-MA	(2) – 14" x 20" x 2" (1) – 14" x 14" x 2"	41
FBM2-5	TPEFYP-054-MA	(3) – 14" x 20" x 2"	46

Part Number	Used on CITY MULTI Models	Filters Included	Net Weight (lbs.)
FBH2-1	TPEFYP-015, 018, 024-MH	(1) – 20" x 24" x 2"	14
FBH2-2	TPEFYP-027, 030-MH	(1) – 20" x 16" x 2", (1) – 20" x 20" x 2"	24
FBH2-3	TPEFYP-036, 048, 054-MH	(2) – 20" x 20" x 2"	27
FBH4-4	TPEFYP-072, 096-MH	(2) – 24" x 24" x 4"	40

TPFFYP (Floor-standing)

Effectively use perimeter areas for space conditioning

TPFFYP floor-standing models are available as exposed or concealed indoor units. At less than nine inches deep, these units are easy to install in peripheral spaces, yet offer highly efficient cooling and heating performance. Their low operating sound and compact size make them ideal for hotel rooms, schools and office buildings.



TPFFYP-RE
Concealed Type



TPFFYP-CS
Exposed Type

KEY FEATURES

- ▶ TPFFYP-RE—designed for applications requiring a built-in, concealed, floor-standing unit
- ▶ TPEFYP-CS—exposed-type model, perfect for most applications and requires no finish work
- ▶ Available in 6,000, 8,000, 12,000, 15,000, 18,000 and 24,000 BTUH
- ▶ Two-speed fan settings
- ▶ The TPFFYP-RE unit can be field converted from top discharge to front discharge

Benefits

OPTIONAL MOUNTING FOR REMOTE CONTROLLER

TPEFYP units can house a remote controller in the top corner (under a cover panel). The remote controller can be mounted on the wall or in the TPEFYP unit.

INSTALLATION FLEXIBILITY

The TPEFYP-RE unit can be field converted from top discharge to front discharge to increase installation flexibility.

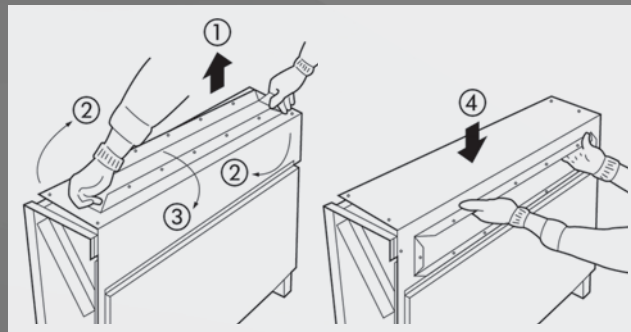

Ideal for closet, attic, or equipment room installations

TPVFYP multi-position air handlers can be connected to a system with other CITY MULTI® indoor units for complete system design flexibility. The multi-position design is suitable for any application, making it ideal for installation in a closet, attic, or an equipment room.



KEY FEATURES

- ▶ Selectable external static pressure up to 0.80
- ▶ Reusable standard-size 1" filter
- ▶ Side return available (P12-P24 only)
- ▶ Unique cabinet insulation design allows for no thermal penetration into the coil section
- ▶ Cabinet can be disassembled to install in very tight spaces
- ▶ Heavy gauge, high-gloss powder coat finish steel cabinets with 1" fiberglass-free foam insulation (R-4.2 insulation value)
- ▶ Accessories available for various custom applications, including two-stage auxiliary heat, fan speed indication, humidifier control, and more
- ▶ Cabinet sections are embossed with fan, coil, and other components for easy identification and maintenance

VERTICAL AIRFLOW

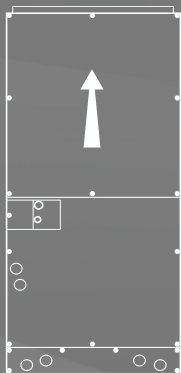

HORIZONTAL LEFT AIRFLOW

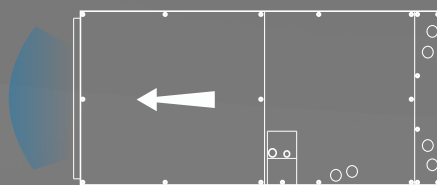

HORIZONTAL RIGHT AIRFLOW

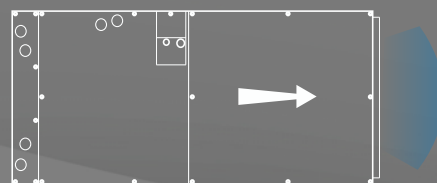

DOWNFLOW AIRFLOW

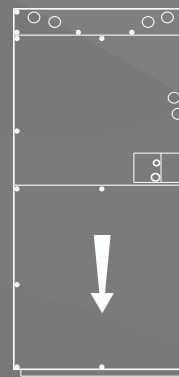

For downflow configurations, the CMA-1 is recommended for proper management of condensate to prevent water blowoff in certain conditions.

TPWFYP

(Hydronic Heat Exchanger)

Heat and cool water, quickly and efficiently

The TPWFYP Hydronic Heat Exchanger is available in two configurations, the HEX (-AU) and the Booster (-BU). Each provides unique solutions to incorporate into an existing VRF system for an efficient means to heat and cool non potable water. The TPWFYP is a closed-circuit water heater that works with the Y-Series or R2-Series outdoor units.



Available Sizes:
36,000 and 72,000 BTUH

TPWFYP036/72AU141A

KEY FEATURES

- ▶ Heats water to 113° F
- ▶ Hydronic heat exchanger transfers energy from refrigerant to water
- ▶ Can be used to recover waste heat from cooling operation to water when combined with any R2-Series, resulting in large energy savings
- ▶ Cools water to 41° F to be used for cooling outside air, cooling pool water, misting stations, process cooling and more
- ▶ Applications include radiant heating, snow melting, reheating air, pre-heating hot water and more



Available Sizes:
36,000 BTUH

TPWFYP036BU140A

KEY FEATURES

- ▶ Heats water to 160° F
- ▶ Hydronic heat exchanger transfers energy from refrigerant to water
- ▶ Compatible with R2- and WR2-Series
- ▶ Can be used to recover waste heat from cooling operation to water, resulting in large energy savings
- ▶ Includes R134A compressor circuit for boosting water temperature
- ▶ Applications include radiant heating, hot water preheating, snow melting, reheating air, warming pools, and more





VENTILATION

Lossnay® Energy Recovery Ventilators (ERVs)/DOAS



LOSSNAY® ENERGY RECOVERY VENTILATORS (ERVs)

Outdoor air solutions for improved indoor environmental quality



KEY FEATURES

- ▶ Lossnay core
- ▶ Over 50% enthalpy exchange efficiency
- ▶ Four fan speeds on 300, 470, 600 models: extra low, low, high, extra high
- ▶ M-NET connectivity for use with CITY MULTI® central controllers and BMS interfaces
- ▶ Sound pressure level: maximum sound level 40.5 dB(A)
- ▶ Three ventilation modes: Auto, Bypass, Heat Recovery

Benefits

INTERLOCK

Networking systems with Mitsubishi Electric air conditioners has never been easier. The M-NET adapter comes standard, and there is no need to purchase additional parts. Systems can be assembled simply and logically, reducing construction time and keeping initial costs low.

SYSTEM COMPATIBILITY

The TLGHF-RX5 series is fully compatible with our controls network, further increasing the scope of total system management.

MULTI-FUNCTION LCD REMOTE CONTROLLER

The compact and attractive remote controller with a liquid crystal display is designed for easy visibility.

- ▶ ON/OFF, Run mode, and Ventilation mode
- ▶ Filter Maintenance Display
- ▶ Controls up to 16 Lossnay units in a single group
- ▶ Night Purge
- ▶ Timer Operations

BYPASS VENTILATION STANDARD

Lossnay models offer three ventilation modes:

- ▶ Energy Recovery—Heat Exchange
- ▶ Bypass—No Exchange
- ▶ Automatic—Heat Exchange/Bypass

With conventional ERVs, bypass ventilation was impossible without attaching additional dampers and adapters. With the TLGHF-RX5 series, however, this mode is available without the use of other parts. An automatic mode allows the system to select recovery or bypass as required. Mode selection is easy when interlocked with M-NET systems using the PZ-60DR remote controller, which is sold separately.



PZ-43SMF



TZ-60DR-E

DEDICATED OUTDOOR AIR SYSTEM (DOAS)

Provides pre-conditioned outdoor air

The award-winning TPEFYF–AF Dedicated Outdoor Air System comes in two configurations, the CFM and the CFMR. Both configurations offer high capacity coils that will condition incoming air, making it suitable for distribution to downstream fan coil units.

KEY FEATURES

- ▶ Single-speed 1200 CFM fan
- ▶ Multiple external static pressure set points
- ▶ Large DX coil with high latent capacity
- ▶ Entering air temperature and humidity sensors factory installed
- ▶ Thin 18-9/16" high cabinet installs in small areas
- ▶ Drain lift mechanism up to 21-11/16" included as standard
- ▶ 50° F to 70° F saturated air available in cooling mode (CFM/TUHYP120)
- ▶ Reheat capabilities using recovered energy from cooling through the branch controller (CFMR/TURYP120)
- ▶ 50° F to 60° F saturated air available leaving cooling coil (CFMR/TURYP120)
- ▶ 63° F to 83° F leaving air temperature available leaving reheat coil (CFMR/TURYP120)



TPEFY-0A

(Ducted Outside Air Unit)

NEW!

Indoor air solutions for improved indoor environmental quality

The TPEFY-0A is a high-performance indoor unit that improves comfort by bringing in fresh air that can be temperature controlled. Pre-treated air is then supplied to each zone, providing comfort to occupants.

The TPEFY-0A is an ideal choice for office buildings, schools, hotels, assisted-living facilities and other applications where ceiling plenum space is available.



KEY FEATURES

- ▶ Ideal for zone control for outside air applications
- ▶ Can be used in conjunction with standard indoor units
- ▶ Three modes of operation: cooling, heating, and fan only
- ▶ Available in 36,000, 48,000, 72,000, and 96,000 BTUH capacities
- ▶ Supply air temperature control ranges from 50° F DB to 80° F DB in cooling mode and 63° F DB to 95° F DB in heating mode
- ▶ Operating temperature range from 63° F DB to 118° F DB in cooling mode and 14° F DB to 59° F DB in heating mode
- ▶ Multiple external static pressure set points from 0.602 to 1.00 in. W.G.
- ▶ Lineup ranges in airflow volume from 350 to 1,200 CFM
- ▶ High-efficiency DC fan motor with three fan speed options
- ▶ Integrated condensate lift mechanism provides up to 27-9/16" of lift
- ▶ Compatible with CITY MULTI outdoor units excluding S-Series (TUMY)
- ▶ Optional filter box available with MERV 13 filters

CONTROLLER FOR TPEFY-0A DUCTED OUTSIDE AIR UNIT

- ▶ Easy-to-use MA remote controller
- ▶ Back-lit LCD screen
- ▶ Basic operations
 - On/Off
 - Preset temperature setting: Cool, Dry, Heat, and Auto
 - Fan speed setting
 - Vane setting
 - Automatic cooling/heating operation
 - Timer: On/Off timer and Auto-off timer
 - Weekly timer
 - Energy saving: Automatic return to the preset temperature, setting the energy-saving operation schedule
 - Ventilation operation



TAR-30MAOA

INDOOR AIR QUALITY

The TPEFYF-OA indoor units provide conditioned outside air to a space, helping building owners, engineers and architects meet requirements for ventilation and increase indoor air quality.

QUIET OPERATION

The specially designed centrifugal fan provides exceptionally quiet operation, even at high operating speeds, down to 35 dB(A).

BUILT-IN CONDENSATE LIFT MECHANISM

The drain pipe can be positioned anywhere up to 27-9/16" from the bottom of the unit allowing for long piping and versatility. A built in safety switch halts operation if the pump experiences a problem or if the drain becomes clogged, ensuring no water leaks occur.



CHOICE OF EXTERNAL STATIC PRESSURE

Additional external static pressure capacity provides flexibility for duct extension, branching, and air outlet configurations. The factory setting can be field-adjusted to match installed ductwork for TPEFYF-OA indoor units. The TPEFYF-OA indoor units are available with up to 1.00" W.G. external static pressure.

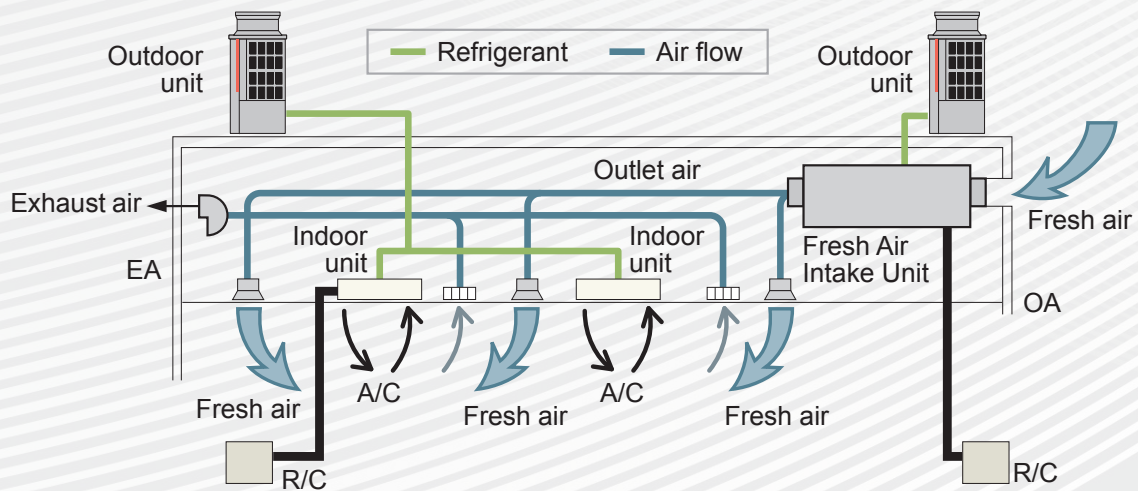



CONTROLS AND SOFTWARE SOLUTIONS

CONTROLS



Our CITY MULTI® Controls Network (CMCN) makes it easy to manage your building

The Integrated Centralized Control Web (ICCW) manages up to 2,000 indoor units from a single networked PC or tablet. The ICCW puts individual, personalized comfort in the hands of the tenants and the building manager.



Benefits

FLEXIBLE DESIGN FOR CUSTOMIZED, INDIVIDUAL ZONE CONTROL

Building owners and engineers can select from a wide variety of remote controllers and other devices to satisfy the exact level of tenant control on a zone-by-zone basis, while providing the ultimate in personal comfort control. The versatility of the CMCN enables each building's controls network to address the specific design and tenant requirements, while providing unparalleled occupant comfort.

OPTIONAL EASY-TO-USE CONTROL VIA PC WEB BROWSER

From a web browser on a PC or tablet, the building manager can now monitor, operate and schedule the HVAC system through the central controller. Plus, the building manager can enable tenants to control their own individual zones via a personal web browser on their networked PC, tablet, or smartphone.

EASY INSTALLATION

The CMCN uses simple, non-polar, two-wire control connections. All components are daisy chained and added onto the M-NET communication bus. It all adds up to less labor and materials with quicker installation.

SINGLE-SOURCE CONTROL FOR UP TO 2,000 INDOOR UNITS

You can control up to 2,000 units with central controllers, empowering the building manager to control the HVAC system for multiple buildings in a business park, educational campus or retirement facility.

ENERGY ALLOCATION

A centralized controller network configured with the energy allocation option and watt-hour meter(s) can calculate the HVAC energy consumption relative to each indoor unit on a per-tenant basis and generate a CITY MULTI energy allocation per tenant. The Energy Allocation feature is available through the TE-200A/TE-50A/TW-50A centralized controllers.

SYSTEM INTEGRATION

Not only can our CMCN act as a standalone building management system, it can also integrate with existing systems via LonWorks® or BACnet®.

The Integrated Centralized Control Web (ICCW) enables the user to control multiple TE-200A / TE-50A/ TW-50A centralized controllers and provide enhanced functions from any networked PC, tablet or smart phone. ICCW is capable of controlling up to 2,000 indoor units in conjunction with our centralized controllers.



ENERGY ALLOCATION

KEY FEATURES

- ▶ Allocates the energy cost of the outdoor unit(s) power consumption to building tenants based on the capacity used by their indoor units
- ▶ Great for condos and multiple tenant spaces
- ▶ Requires a software license (SW-CHARGE MASTER)

TABLET

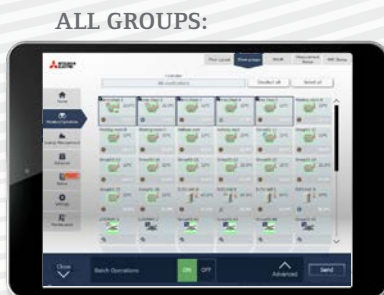

SMARTPHONE



Note: requires a license (SW-Pweb Master)

CENTRALIZED CONTROLLER

TE-200A/TE-50A

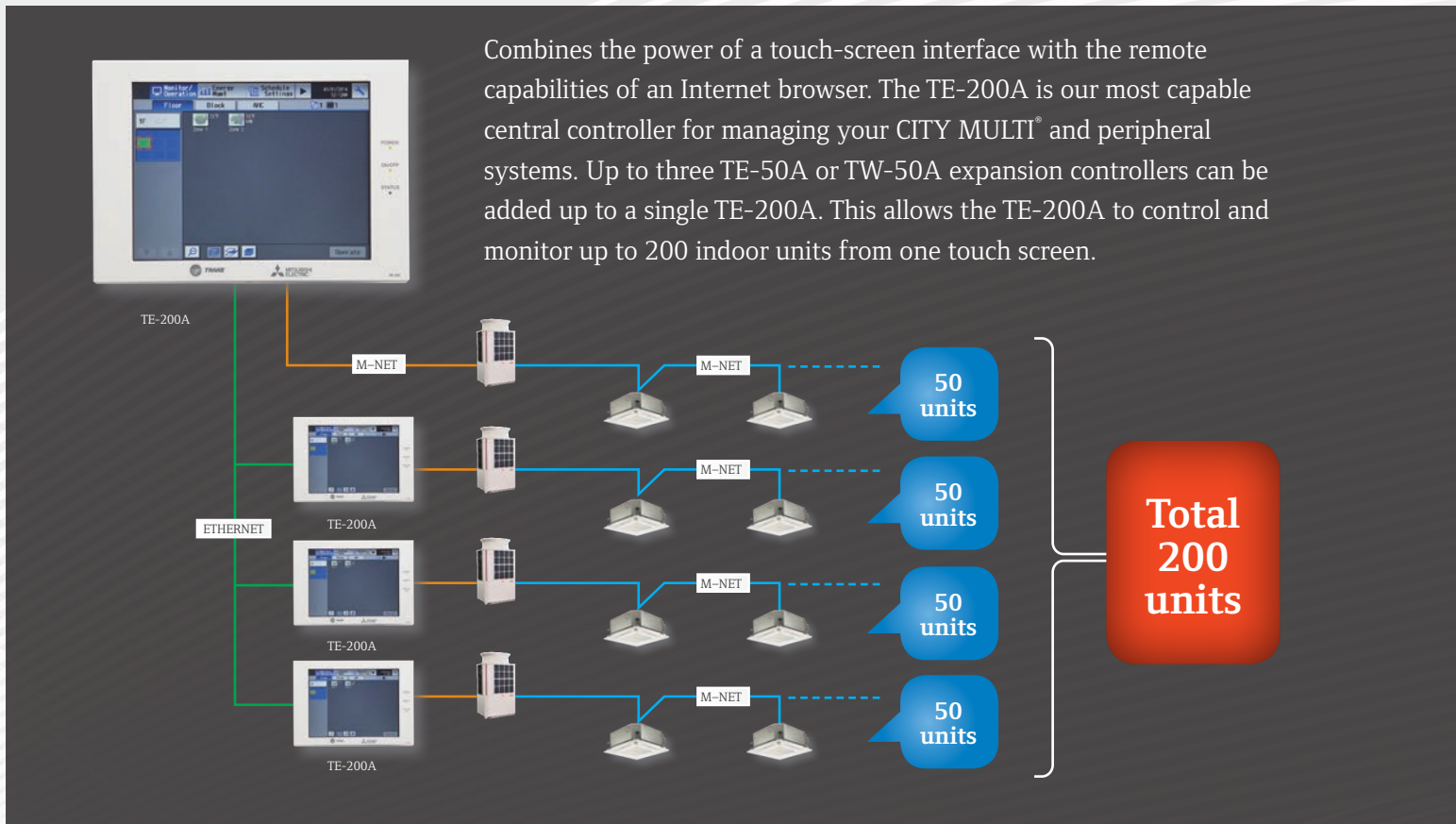

Combines the power of a touch-screen interface with the remote capabilities of an Internet browser. The TE-200A is our most capable central controller for managing your CITY MULTI® and peripheral systems. Up to three TE-50A or TW-50A expansion controllers can be added up to a single TE-200A. This allows the TE-200A to control and monitor up to 200 indoor units from one touch screen.

PROVIDE ASSISTANCE IN IDENTIFYING ENERGY SAVINGS BY COMPREHENSIVELY SHOWING THE ENERGY CONSUMPTION OF HVAC EQUIPMENT

Energy consumption of HVAC equipment by individual area is displayed graphically on the controller's interface. This enables comparisons with the previous year's power consumption as well as provides a view to performance against electric usage targets. Floor layout is displayed on the 10.4" LCD touch panel which facilitates easier operation of HVAC equipment.

ESTABLISH THE OPTIMAL SYSTEM BASED ON THE SCALE OF YOUR FACILITY

The TE-200A allows a user to control up to 50 indoor units. The TE-200A can increase its control capabilities to a maximum of 200 indoor units with the addition of three TE-50A expansion controllers. A PC or tablet connection enables the control of more than 200 indoor units via the ICCW browser.

DUAL SET POINT

When the operation mode is set to Auto (dual set point), two preset temperatures can be set. Depending on the room temperature, the indoor unit will automatically operate in either the Cool or Heat mode to keep the room temperature within the preset range.

MONITOR AND OPERATE THE HOT WATER HEAT PUMP THROUGH THE ADDITION OF A TPWFYP

Centralized batch control with the TPWFYP is made possible through the use of an TE-200A/TE-50A.



The TE-50A centralized controller can only expand an TE-200A controller, it cannot be used by itself. Three TE-50A controllers can expand an TE-200A to monitor 200 indoor units. It features advanced functionality with expanded monitoring, control, dual set point and trending abilities.

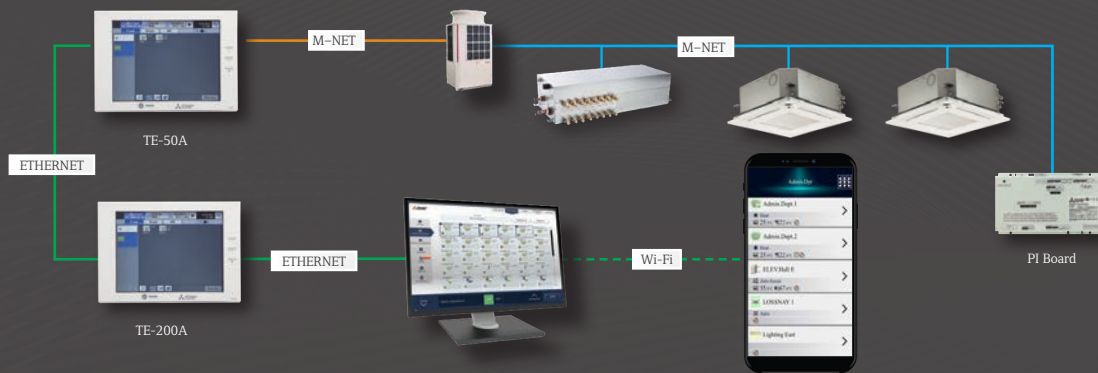

CONTROL SCREEN FOR POWER CONSUMPTION

Energy consumption of an applicable area can be displayed by the month, day, and/or hour. Energy consumption of two different units, groups and block, can be compared within the software. The energy consumption of the fan(s) can be displayed as well.

Energy consumption of the HVAC equipment is ranked and displayed by each unique area, thus visualizing high-load components within the system. In addition, a comparison of energy consumption alongside target electric energy usage is possible.

STANDARD FEATURES

Function	Description
Touch Screen	10.4" high resolution color touch screen
Max No. of Indoor Units	Up to 200 indoor units can be controlled and monitored when three expansion controllers (TE-50A and/or TW-50A) are networked together.
ON/OFF	On/Off operation for a single group and batch operation
Operation Mode	Setback/Cool/Dry/Auto (R2- and WR2-Series)/Fan/Heat
Temperature Setting	Supports single and dual set point operation with extended set temperature range
Fan Speed Setting	Hi/Mid-2/Mid-1 /Low/Auto (Available fan speed settings depending on indoor unit)
Airflow Direction Setting	Swing/Horizontal/Mid-0/Mid-1/Mid-2/Mid-3/Auto (settings vary depending on indoor unit model)
Permit/Prohibit Function	Individual prohibit operations for each remote controller function (ON/OFF, Set Temperature, Operation Mode and FilterReset)
Indoor Return Air Temperature	Displays the measured return air temperature from each group
Error Indication	Displays a four-digit code and the affected unit address
Test Run Function	Allows indoor units to operate in test mode
Ventilation Interlock	Allows the group to be interlocked with Lossnay unit
Schedule Operation	Annual, Weekly, and Today schedules
External Input/Output	Inputs: Level Signal — Batch Start/Stop, Batch Emergency Stop Outputs: Start/Stop Status, Error/Normal Status
Power Supply	Built-in
Dimensions — (H x W x D)	7-27/32" x 11-5/32" x 2-17/32"

CENTRALIZED CONTROLLER

TW-50A



The TW-50A centralized controller is a web browser-only centralized controller for managing CITY MULTI® and peripheral systems. The TW-50A can also connect to an TE-200A over Ethernet to expand its monitoring capability to up to 200 indoor units when three TW-50A units are used. The TW-50A features advanced functionality with expanded monitoring, control, dual set point and trending abilities.

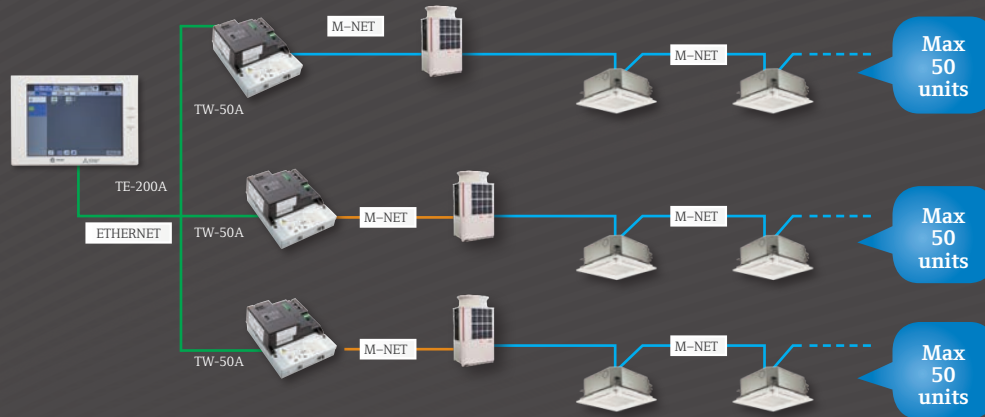

STANDARD FEATURES

FUNCTION	DESCRIPTION
Max No. of Indoor Units	Up to 50 indoor units can be controlled and monitored
ON/OFF	On/Off operation for a single group and batch operation
Operation Mode	Setback /Cool/Dry/Auto (R2- and WR2-Series)/Fan/Heat
Function	Hold (temporarily disables schedules)/Initial setting/Operation data back-up
Displays	CITY MULTI compressor speed and hi/low pressure/AdvancedHVAC Controller (DC-AIO) input/output status/Space temperature and humidity (from SmartME or AI controller)/Error code (four-digit code and the affected unit address)/Unoccupied setback temperature range/Occupancy and brightness status from the SmartME remote controller
Temperature Setting	Supports single and dual set point operation with extended set temperature range
Fan Speed Setting	Hi/Mid-2/Mid-1/Low/Auto (Available fan speed settings depending on indoor unit)
Airflow Direction Setting	Swing/Horizontal/Mid-0/Mid-1/Mid-2/Mid-3/Auto (settings vary depending on indoor unit model)
Permit/Prohibit Function	Individual prohibit operations for each remote controller function include ON/OFF/Set Temperature/Fan speed and direction/Operation Mode/Filter Reset
Ventilation Interlock	Allows the group to be interlocked with Lossnay unit
Schedule Operation	Annual, Today, and Weekly schedules
External Input/Output	Inputs: Level Signal-Batch Start/Stop, Batch Emergency Stop Outputs: Start/Stop Status, Error/Normal Status (requires PAC-YG10HA)
Trending Data	Fan operation time/Thermo-on time/Set temperature/Room temperature/AI controller temperature and humidity
Power Supply	Built-in
Dimensions – (H x W x D)	8-4/16" x 6-13/16" x 3-10/16"



Customized individual zone control via a bright and easy-to-use touchscreen interface. The TT-24B-J is perfect for light commercial and residential applications.



STANDARD FEATURES

FUNCTION	DESCRIPTION
Max No. of Indoor Units	Up to 24 indoor units can be connected
ON/OFF	On/Off operation for a single group and batch operation
Operation Mode	Setback /Cool/Dry/Auto (R2- and WR2-Series)/Fan/Heat
Temperature Setting	Supports single and dual set point modes/Set temperature from 57° F – 87° F depending on operation mode and indoor unit
Fan Speed Setting	Hi/Mid-2/Mid-1 /Low/Auto (Available fan speed settings depending on indoor unit)
Airflow Direction Setting	Airflow angles: 100° – 80° – 60° – 40° and swing/Airflow direction settings vary depending on indoor unit model
Permit/Prohibit Function	Individual prohibit operations for each remote controller function (ON/OFF, Set Temperature, Operation Mode and Filter Reset)
Indoor Return Air Temperature	Displays the measured return air temperature from each group
Error Indication	Displays a four-digit code and the affected unit address
Ventilation Interlock	Allows the group to be interlocked with Lossnay unit
Schedule Operation	Weekly schedule can be set by groups based on operation pattern
External Input/Output	Inputs: Level Signal-Batch Start/Stop, Batch Emergency Stop Outputs: Start/Stop Status, Error/Normal Status
Power Supply	PAC-SC51KUA
Dimensions – (H x W x D)	4-3/4" x 7-1/8" x 1-3/16"

LICENSE OPTIONS FOR CENTRALIZED CONTROLLERS

Centralized controllers support operations that supersede simple control of the HVAC system and include system configuration, scheduling, batch operation, and malfunction monitoring through license options. These license options further expand the functionality of our centralized controller offerings.

OPTIONAL LICENSES

PERSONAL WEB BROWSER (SW-PWEB)

Allows facility managers to provide individual users control of only their zoned air conditioning via personal networked PC, tablet or smart phone with or without remote controllers. Personal web browser is only supported on TE-200A, TE-50A, and TW-50A centralized controller

BACnet TCP/IP COMMUNICATION (SW-BACNET)

Allows for BACnet® TCP/IP communication from a centralized controller to third-party building management software via an Ethernet connection. The BACnet license is only supported on the TE-200A, TE-50A, and TW-50A centralized controllers.

ENERGY ALLOCATION (SW-CHARGE)

Provides the ability for the TE-200A to allocate the outdoor unit(s) power consumption to building tenants based on the capacity used by their indoor units. Note that there are additional components required to complete a full Energy Allocation installation.

	PART NUMBER	DESCRIPTION	TE-200A	TE-50A	TW-50A
OPTIONAL LICENSES	SW-Charge	Energy Allocation	•	•	•
	SW-Pweb	Personal Web Browser	•	•	•
	SW-BACnet	BACnet® TCP/IP communication	•	•	•
OPTIONAL ACCESSORIES	PAC-YG84UTB-J	Electric Box	•	•	
	PAC-YG86TK-J	Mounting Kit (for control panel)	•	•	
	PAC-YG82TB-J	Mounting Attachment (for wall surface)	•	•	
	PAC-YG72CWL-J	Surface cover with USB port	•	•	



PAC-YG82TB-J



PAC-YG84UTB-J



PAC-YG86TK-J



PAC-YG72CWL-J



The PAC-YG60MCA Pulse Input (PI) Controller makes it possible to perform energy saving and energy allocation initiatives. A maximum of four (4) measurement meters (WHM, gas meter, water meter, and calorie meter) can be connected to the PI Controller and trended within the Centralized Controller. (Note: 24VDC power needs to be provided on-site.)



STANDARD FEATURES

FUNCTION	DESCRIPTION
Display	Displays measurement data via TE-200A, TE-50A, and TW-50A web browser
Monitor	Watt-hour meter, water meter, gas meter, calorimeter
Input	Quantity of 4 non-voltage pulse inputs
Fail-safe device	An internal capacitor will continue to track time for one week in the event of a power failure
Power Supply	24 VDC, 5 W, 0.2 A
Communication	M-NET
Dimensions — (H x W x D)	1-13/16" x 7-7/8" x 4-3/4"

INPUT/OUTPUT CONTROLLERS

PAC-YG66DCA & PAC-YG63MCA



The PAC-YG66DCA Digital Input Digital Output (DIDO) controller makes it possible to control and schedule on/off for general-purpose equipment with an TE-200A, TE-50A, TW-50A, or TT-24B-J centralized controller. Connect up to six (6) pieces of equipment to the DIDO controller. The equipment can either be scheduled or interlocked with indoor units through the use of a centralized controller. (Note: 24 VDC power is required on-site.)

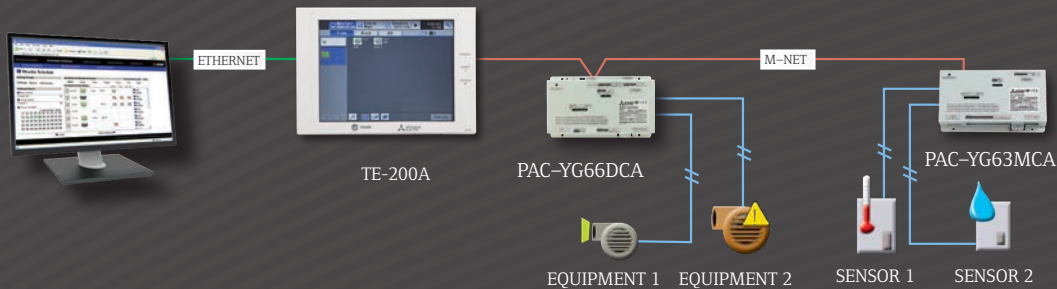

STANDARD FEATURES

FUNCTION	DESCRIPTION
Inputs	Qty two Digital Status Inputs and 2 Digital Error Inputs (Non-Voltage Contacts)
Outputs	Qty two Digital Outputs (Non-Voltage Relay Contact Use only VDC with outputs)
Monitor	Status, Fault Requires TE-200A, TE-50A, TW-50A, or TC-24B Centralized Controller
Control	On/Off, Start/Stop, Enable/Disable Requires TE-200A, TE-50A, TW-50A, or TT-24B-J Centralized Controller
Schedule Operation	Weekly schedule can be set by groups based on operation pattern Requires TE-200A, TE-50A, TW-50A, or TT-24B-J Centralized Controller
Interlock Function	Interlock M-NET devices and output contacts according to status of input contacts
Power Supply	24 VDC (5W plus loads)
Communication	M-NET
Dimensions — (H x W x D)	4-3/4" x 7-7/8" x 1-13/16"



The AI Controller makes it possible to monitor values measured by the temperature and humidity sensors connected to the AI Controller. The AI Controller has two input and two output channels and is required to be connected with an TE-200A, TE-50A, or TW-50A centralized controller. The user can trend measured data on a Web browser and set alarms to output via e-mail when data exceeds a preset upper or lower limit. (Note: 24 VDC power is required on-site.)

STANDARD FEATURES

FUNCTION	DESCRIPTION
Inputs	Qty two Analog Inputs (0/10 VDC, 4/20 mA, 1-5 VDC)
Monitor	Temperature and/or Humidity Requires TE-200A, TE-50A or TW-50A centralized controller and field supplied sensor
Interlock Function	Interlock M-NET devices and output contacts according to measured values on inputs
Alarms	Generate alarm based on user defined high and low limits
Power Supply	24 VDC (5W)
Communication	M-NET
Dimensions — (H x W x D)	4-3/4" x 7-7/8" x 1-13/16"



TAR-U01MEDU-K

SMART ME CONTROLLER®

KEY FEATURES

- ▶ Intuitive backlit touch screen
- ▶ Group control up to 16 indoor units in a single zone
- ▶ Onboard temperature, humidity, occupancy, and brightness sensors
- ▶ Monitors third-party equipment through AdvancedHVAC controller
- ▶ Supports dual set point and setback functions
- ▶ Improved scheduling
- ▶ Color glow status indicator LED bar
- ▶ Dimensions (H x W x D): 4-3/4" x 5-9/16" x 1"

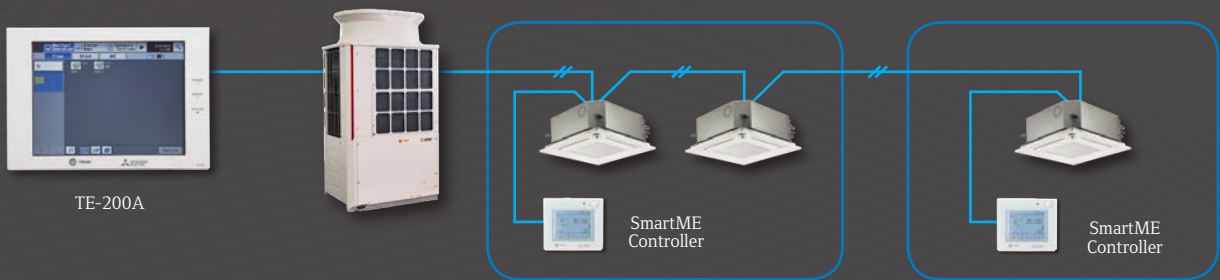

COLOR GLOW STATUS INDICATOR



The LED bar indicates the operation status by lighting and blinking with different colors and brightness (High/Low), or by turning off. Multiple operation status indicators include blue (Cooling), light blue (Drying), yellow (Fan), white (Auto), green (Setback), red (Heating) and lime (Energy Save). Advanced settings are available for selecting desired color per mode, LED brightness (in conjunction with room brightness sensor), and temperature range indicator.

ENERGY SAVE FUNCTION

The Energy Save function reduces energy consumption during vacancy. The user can select a mode for the Energy Save function which is activated based on vacancy detection in a room, including the following:

- ▶ Thermo-off: Puts the unit into the Thermo-off state
- ▶ Set temperature offset: Offsets the set temperature
- ▶ Fan speed down: Sets the fan speed to Low
- ▶ ON/OFF: Turns off the unit
- ▶ Operation mode: Sets the operation mode to Setback

OCCUPANCY SENSOR

The built-in Occupancy Sensor is used to detect movement in a room. If the sensor detects no movement (or "vacancy") it will activate the selected Energy saving function mode. The Occupancy Sensor returns the system to original operating status after detecting movement. The user can adjust the away time and detection sensitivity threshold level for the Occupancy Sensor. Brightness can also be used in conjunction with motion to determine occupancy.

ZONE CONTROLLERS

TOUCH MA & kumo cloud®

Full color, touch panel customizable display



TAR-CT01MAU-SB

TOUCH MA

KEY FEATURES

- ▶ Controls up to 16 indoor units
- ▶ Backlit LCD: full color, touch screen display includes 180 color patterns
- ▶ ON/OFF timer: turns on and off daily at a set time
- ▶ Fan speed settings
- ▶ Large icons for easy readability
- ▶ Bluetooth® app for users & installer
- ▶ Dimensions: 2-9/16" x 4-23/32" x 9/16"
- ▶ Customize display with customer logo or background colors

kumo cloud®

KEY FEATURES

- ▶ Compatible with CITY MULTI® and M- and P-Series systems without a central controller
- ▶ Requires the Trane®/ Mitsubishi Electric Wireless Interface 2 (PAC-USWHS002-WF-2)
- ▶ Easy to connect the device to your 2.4Ghz Wi-Fi network using the kumo cloud app
 - The wireless interface 2 does not support 5.0Ghz Wi-Fi networks
- ▶ App compatible software platforms:
 - Apple iOS 8.0 or later
 - Android 4.1 or later
 - Fire OS 4.1 or later
- ▶ Intuitive settings for simplified use:
 - Group units together
 - Organize groups into sites
 - Batch command units
- ▶ Error and filter status pop-up
- ▶ Advanced functions settings for M- and P-Series equipment



Apple and the App Store are registered trademarks of Apple, Inc.

Amazon, Alexa, Fire and all related logos are trademarks of Amazon.com, Inc. or its affiliates.

Google play is a registered trademark of Google, Inc.

Wired remote controller ideal for easy operation, convenience, and energy savings



PAR-33MAA

KEY FEATURES

- ▶ Controls up to 16 zones
- ▶ Large easy-to-see backlit LCD with two display modes: Full or Basic
- ▶ Interlock and control Lossnay units
- ▶ Operation modes: Auto, Cool, Heat, Dry, Fan
- ▶ Fan speed settings
- ▶ Controls air direction (vane direction and ventilation)
- ▶ Dimensions: 4-3/4" x 3/4" x 4-3/4"
- ▶ Dual set point functionality
- ▶ Automatically adjust for Day Light Savings time
- ▶ Control i-see Sensor™ equipped cassettes indoor units

Easy-to-use remote for temperature and operation mode control



TAC-YT53CRAU-J

SIMPLE MA

KEY FEATURES

- ▶ Controls up to 16 zones
- ▶ Backlit LCD
- ▶ Operation modes of Cool, Heat, Dry, Fan, Auto, Ventilation, Setback (depending on connected equipment)
- ▶ Fan speed settings
- ▶ Controls air direction (vane direction and ventilation)
- ▶ Dimensions: 2-3/4" x 1-5/8" x 4-3/4"
- ▶ Dual set point functionality

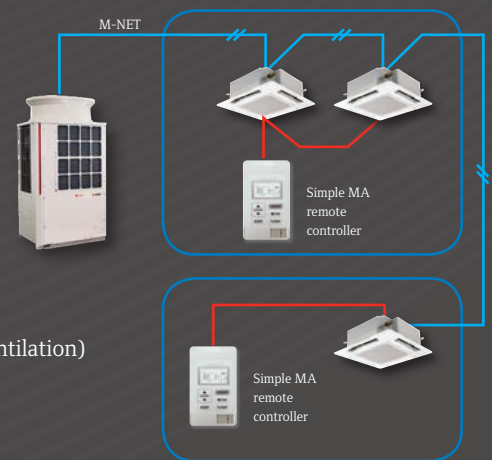

Easy-to-use hand-held remote for temperature and operation mode control for CITY MULTI® and P-Series systems



TAR-FL32MA-E

WIRELESS MA REMOTE CONTROLLER AND MA RECEIVER

KEY FEATURES

- ▶ Hand-held wireless remote control of up to 16 indoor units
- ▶ Operation modes of Cool, Heat, Dry, Fan, Auto, Ventilation
- ▶ Fan speed, airflow direction settings
- ▶ Compatible with P-Series and CITY MULTI systems
- ▶ Requires TAR-FL32MA-E Wireless Receiver. (Built-in as standard on TPKFYF models)
- ▶ Dimensions — Remote: 2-5/16" x 3/4" x 5-1/4"
Receiver: 2-3/4" x 7/8" x 4-12/16"

The CMCN supports integration with Building Management Systems (BMS) via LonWorks® and BACnet®

The Mitsubishi Electric LonWorks interface, LMAP04U, supports up to 50 indoor units with a variety of network variables on a per indoor unit basis. Input variables include, but are not limited to: On/Off, Operation Mode, Fan Speed, Prohibit Remote Controller, and Filter Sign Reset. Output variables include but are not limited to: Model Size, Alarm State, Error Code, and Error Address.



LONWORKS

KEY FEATURES

- ▶ Up to 50 units (CITY MULTI®, Nv-Series, P-Series and/or Lossnay) can be connected with one LonWorks interface
- ▶ Operation/Setting: Request On/Off, Set Point, Request Lossnay Mode, Request Fan Speed, Request Local Prohibit On/Off and Set Point, Request Forced Thermostat Off, Filter Sign Reset, Time Stamp, Request Limit Temperature Setting Range, Request Simplified Locking
- ▶ Features a built-in power supply (208/230 VAC)
- ▶ Dimensions: 13-7/16" x 14-3/16" x 2-3/8"

The TE-200A/TE-50A/TW-50A centralized controllers are BTL (BACnet Testing Laboratories) listed, demonstrating their compliance with ASHRAE standards and their compatibility with building management systems supporting the BACnet TCP/IP communication protocol.

BACnet® License

KEY FEATURES

- ▶ Connect up to 50 indoor units per licensed centralized controller
- ▶ Supports the monitoring and operation of CITY MULTI indoor units, Nv- and P-Series indoor units (requires additional adapter), and Lossnay® ERV units
- ▶ BACnet TCP/IP Ethernet connection only

See page 64 for licensing centralized controllers

Diamond System Builder is an interactive system layout tool providing a simple and efficient means of system design

Diamond System Builder (DSB) helps users determine the cooling and heating output of selected equipment for project-specific conditions. The program has error indicators and built-in safeguards against exceeding limitations, assuring line lengths, maximum connected capacities, component selections, control schemes, etc. are within the system requirements.

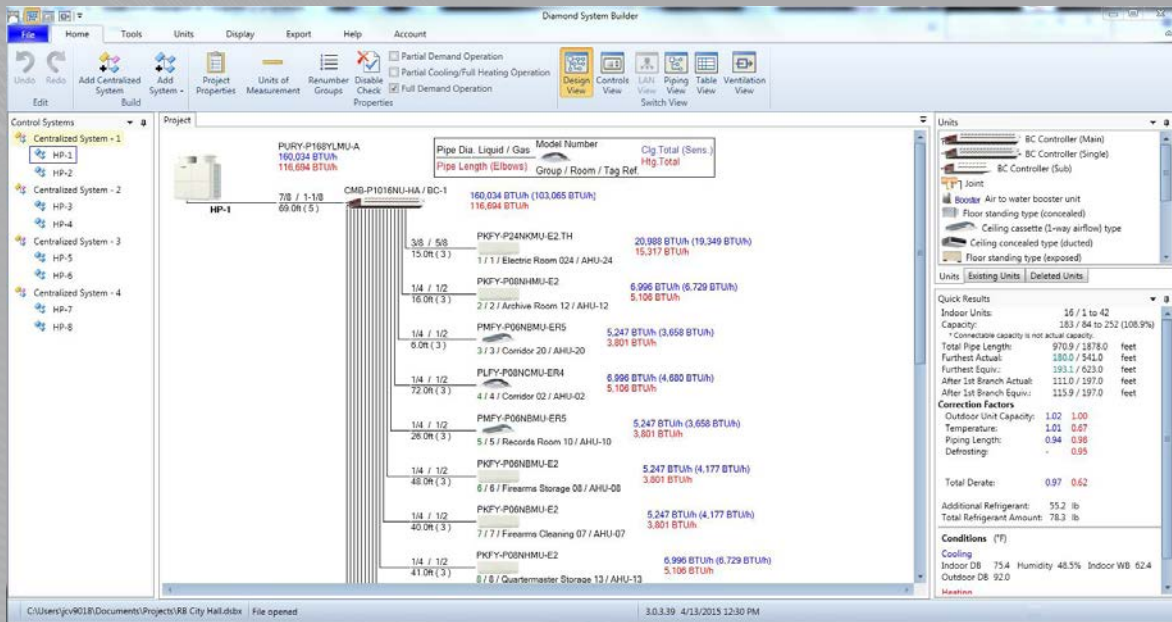

PROJECT PROPERTIES

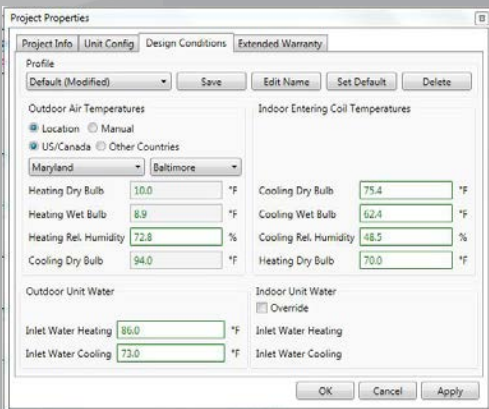

System design conditions, such as indoor and outdoor design conditions, are easily entered for both cooling and heating. Customer and project names can be entered to identify the job on the outputs.

DSB INTERFACE

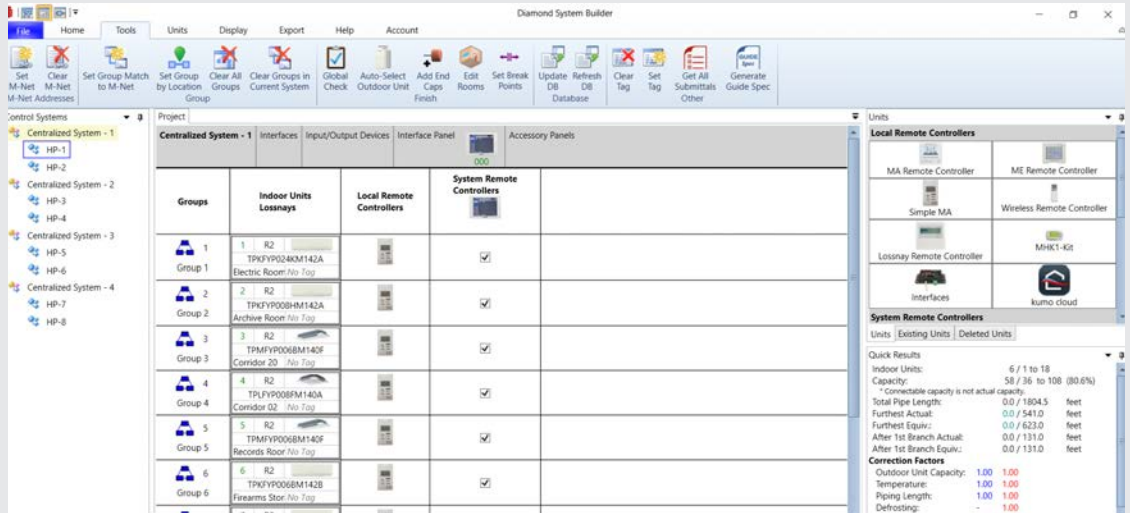

Optional functions to customize the system layout to your project are available, such as labeling groups with a room name, adding equipment tags to pieces of equipment, and giving each system a project-specific name. Other features, like a custom equipment schedule, submittal packages, and AutoCAD drawings are available once the system layout has been finalized.

REVIT AND AUTOCAD OUTPUTS

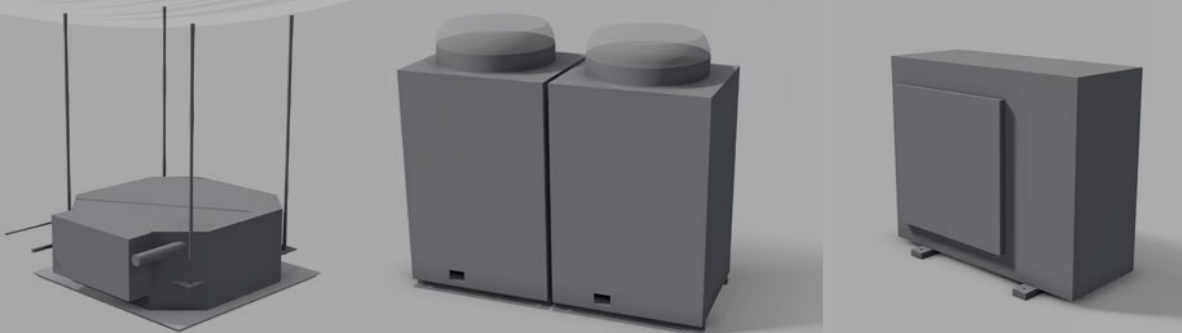

Easy-to-use, Windows®-based Maintenance Tool software

The new Universal Maintenance Tool software is the fast and easy way to monitor operation of CITY MULTI®, Nv-Series and P-Series systems.* Upgrades to hardware and software allow for efficient access to system data, reducing time needed to determine operational status and troubleshoot system errors. Monitor temperature, pressure, Linear Expansion Valve (LEV) position, electrical data and much more. Information is updated every minute. View status of connected indoor units among many other capabilities.

Maintenance Tool also allows a user to record and save system data for trending and future error code analysis as well as extended warranty and troubleshooting purposes.

*Separate cables required to access Nv-Series and P-Series data.

MN-CONVERTER

KEY FEATURES

- ▶ MN-Converter features a sleek design that fits in the palm of your hand
- ▶ Efficiently pinpoint and troubleshoot system errors
- ▶ Easily access more system data in multiple ways
- ▶ Animated graphics-based system view enables easier on-site diagnosis and troubleshooting
- ▶ Directly connectable to a PC via USB cable
- ▶ Includes built-in SD CARD for capturing system operational data - after connecting to M-NET



PAC-USCMS-MN-1

Maintenance Tool data is automatically stored on the SD card, eliminating the need for a PC, until you want to review the data on the SD card.

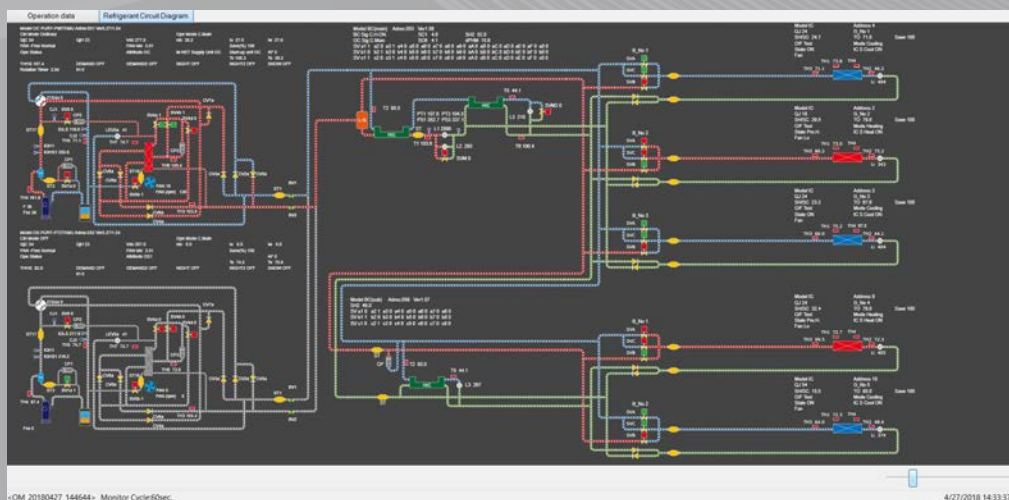

The Operation Status view displays the operational data for the connected system, including system pressures, temperatures, LEV position, compressor frequency, current operation mode, and more.



The background features a dark blue grid with a perspective effect. On the left side, there are faint, semi-transparent data visualizations, including a bar chart and a line graph. The overall aesthetic is technical and modern.

*SPECIFICATION TABLES
OUTDOOR AND INDOOR*





SPECIFICATIONS: ▼
R2-SERIES (STANDARD-EFFICIENCY)

TURYP (3/4) AN40A**

SPECIFICATION			MODEL NAMES				
VOLTAGES	208V /230V		TURYP0723AN40A(N/B)	TURYP0963AN40A(N/B)	TURYP1203AN40A(N/B)	TURYP1443AN40A(N/B)	TURYP1684AN40A(N/B)
	460V		TURYP0724AN40A(N/B)	TURYP0964AN40A(N/B)	TURYP1204AN40A(N/B)	TURYP1444AN40A(N/B)	TURYP1684AN40A(N/B)
Power Source			3-phase 3-wire 208-230 V ±10% 60 Hz				
			3-phase 3-wire 460 V ±10% 60 Hz				
Capacity (Nominal)	Cooling	BTUH	72,000	96,000	120,000	144,000	168,000
	Heating	BTUH	80,000	108,000	135,000	160,000	188,000
Electrical Supply	MCA	A	24/22 11	33/30 15	43/40 18	52/48 20	61/57 28
	MOP	A	40/35 15	50/45 20	70/60 25	80/70 30	100/90 40
	SCCR	A	5				
	Recommended Fuse Size	A	30/30	40/40	50/50	60/60	70/70
			15	20	25	30	40
Fan	Type X Quantity		Propeller fan x 1	Propeller fan x 2	Propeller fan x 2	Propeller fan x 2	Propeller fan x 2
	Airflow Rate	CFM	6,000	7,400	8,300	9,550	14,850
	External Static Pressure		Selectable; 0, 0.12, 0.24, 0.32 in.WG; factory set to 0 in.WG				
Compressor	Type X Quantity		Inverter scroll hermetic compressor x 1				
	Operating Range		15% to 100%	15% to 100%	15% to 100%	15% to 100%	15% to 100%
	Lubricant		MEL32				
Refrigerant	Type		R410A				
External Finish			Pre-coated galvanized steel sheet (+powder coating for -BS type) <MUNSELL 5Y 8/1>				
Dimensions	Height	In.	71-5/8				
	Width		36-1/4	48-7/8	48-7/8	48-7/8	68-29/32
	Depth		29-5/32				
Net Weight	lbs.	483	576	598	646	739	
		516	611	633	682	774	
Sound Pressure Level (Measured in Anechoic Room)		dB(A)	56.5/58.0	58.5/60.0	60.0/62.0	65.0/65.5	62.5/66.5
Sound Power Level (Measured in Anechoic Room)		dB(A)	75.5/77.0	77.5/79.0	80.0/80.5	85.5/85.5	81.0/85.5
Protection Devices	High Pressure		High pressure sensor, High pressure switch at 4.15 MPa (601 psi)				
	Inverter Circuit (Compressor/Fan)		Over-heat protection, Over-current protection				
Refrigerant Pipe Dimensions	Liquid (High Pressure) (Brazed)	In.	5/8 Brazed	3/4 Brazed	3/4 Brazed	7/8 Brazed	7/8 Brazed
	Gas (Low Pressure) (Brazed)		3/4 Brazed	7/8 Brazed	1-1/8 Brazed	1-1/8 Brazed	1-1/8 Brazed
Indoor Unit Connectable	Total capacity		50-150% of outdoor unit capacity				
	Model / Quantity		P05-P96/1-18	P05-P96/1-24	P05-P96/1-30	P05-P96/1-36	P05-P96/1-42
Guaranteed Operating Range *1	Cooling (Outdoor) *2		23-126°F (-5-52°C)				
	Heating (Outdoor) *3		-4-60°F (-20-15.5°C)				
Extended Operating Range *4	Heating (Outdoor)		-18-60°F (-28-15.5°C)				
Efficiency Ratings *5	EER (Ducted/Non-Ducted)		13.1 / 14.7	12.8 / 14.5	12.1 / 13.2	11.0 / 12.2	10.6 / 11.0
	IEER (Ducted/Non-Ducted)		23.8 / 29.2	25.5 / 31.9	23.3 / 28.8	23.1 / 28.7	21.3 / 25.8
	COP (Ducted/Non-Ducted)		3.76 / 4.09	3.88 / 4.14	3.61 / 4.01	3.43 / 3.84	3.30 / 3.80
	SCHE (Ducted/Non-Ducted)		25.9 / 25.5	23.5 / 28.3	25.3 / 29.1	24.8 / 27.7	24.7 / 28.3

NOTES:

Nominal cooling conditions (Test conditions are based on AHRI 1230) Indoor: 80°F D.B./67°F W.B. (26.7°C D.B./19.4°C W.B.), Outdoor: 95°F D.B. (35°C D.B.)

Nominal heating conditions (Test conditions are based on AHRI 1230) Indoor: 70°F D.B. (21.1°C D.B.), Outdoor: 47°F D.B./43°F W.B. (8.3°C D.B./6.1°C W.B.)

1. Harsh weather environments may demand performance enhancing equipment. Ask your Trane representative for more details about your region.

2. For details on extended cooling operation range down to -10° F DB, see Low Ambient Kit Submittal.

3. When applying product below -4°F, consult your design engineer for cold climate application best practices, including the use of a backup source for heating.

4. Unit will continue to operate in extended operating range, but capacity is not guaranteed.

5. Efficiency ratings are based on AHRI 1230 test method



TURYP** (3/4) BN40A

SPECIFICATIONS			MODEL NAMES			
VOLTAGES	208V /230V		TURYP1923BN40A(N/B)	TURYP2163BN40A(N/B)	TURYP2403BN40A(N/B)	TURYP2643BN40A(N/B)
		With 2 TURYP0963AN40A(N/B)	With 1 TURYP1203AN40A(N/B) and 1 TURYP0963AN40A(N/B)	With 2 TURYP1203AN40A(N/B)	With 1 TURYP1443AN40A(N/B) and 1 TURYP1203AN40A(N/B)	
	460V		TURYP1924BN40A(N/B)	TURYP2164BN40A(N/B)	TURYP2404BN40A(N/B)	TURYP2644BN40A(N/B)
		With 2 TURYP0964AN40A(N/B)	With 1 TURYP1204AN40A(N/B) and 1 TURYP0964AN40A(N/B)	With 2 TURYP1204AN40A(N/B)	With 1 TURYP1444AN40A(N/B) and 1 TURYP1204AN40A(N/B)	
Power Source			3-phase 3-wire 208-230 V ±10% 60 Hz			
			3-phase 3-wire 460 V ±10% 60 Hz			
Capacity (Nominal)	Cooling	BTUH	192,000	216,000	240,000	264,000
	Heating	BTUH	215,000	243,000	270,000	295,000
Electrical Supply	MCA	A	Refer to: TURYP0963AN40A(N/B)	Refer to: TURYP1203AN40A(N/B) TURYP0963AN40A(N/B)	Refer to: TURYP1203AN40A(N/B)	Refer to: TURYP1443AN40A(N/B) TURYP1203AN40A(N/B)
	MOP	A				
	SCCR	A	TURYP0964AN40A(N/B)	TURYP1204AN40A(N/B) TURYP0964AN40A(N/B)	TURYP1204AN40A(N/B)	TURYP1444AN40A(N/B) TURYP1204AN40A(N/B)
	Recommended Fuse Size	A				
Fan	Type X Quantity					
	Airflow Rate	CFM				
	External Static Pressure					
Compressor	Type X Quantity					
	Operating Range		7.5% to 100%	7.5% to 100%	7.5% to 100%	7.5% to 100%
Refrigerant	Lubricant		Refer to: TURYP0963AN40A(N/B)	Refer to: TURYP1203AN40A(N/B) TURYP0963AN40A(N/B)	Refer to: TURYP1203AN40A(N/B)	Refer to: TURYP1443AN40A(N/B) TURYP1203AN40A(N/B)
	Type					
External Finish						
Dimensions	Height	In.				
	Width		TURYP0964AN40A(N/B)	TURYP1204AN40A(N/B) TURYP0964AN40A(N/B)	TURYP1204AN40A(N/B)	TURYP1444AN40A(N/B) TURYP1204AN40A(N/B)
	Depth					
Net Weight		lbs.				
Sound Pressure Level (Measured in Anechoic Room)		dB(A)	61.5/63.0	62.5/64.5	63.0/65.0	66.5/67.5
Sound Power Level (Measured in Anechoic Room)		dB(A)	80.5/82.0	82.0/83.0	83.0/83.5	87.0/87.0
Protection Devices	High Pressure		High pressure sensor, High pressure switch at 4.15 MPa (601 psi)			
	Inverter Circuit (Compressor/Fan)		Over-heat protection, Over-current protection			
Refrigerant Pipe Dimensions	Liquid (High Pressure) (Brazed)	In.	7/8 Brazed	7/8 Brazed (1-1/8 Brazed for the part that exceeds 65 m)	7/8 Brazed (1-1/8 Brazed for the part that exceeds 65 m)	1-1/8 Brazed
	Gas (Low Pressure) (Brazed)		1-1/8 Brazed	1-1/8 Brazed	1-3/8 Brazed	1-3/8 Brazed
Indoor Unit Connectable	Total capacity		50-150% of outdoor unit capacity			
	Model / Quantity		P05-P96/1-48			
Guaranteed Operating Range *1	Cooling (Outdoor) *2		23-126°F (-5-52°C)			
	Heating (Outdoor) *3		-4-60°F (-20-15.5°C)			
Extended Operating Range *4	Heating (Outdoor)		-18-60°F (-28-15.5°C)			
Efficiency Ratings *5	EER (Ducted/Non-Ducted)		11.9 / 13.5	11.6 / 13.0	11.2 / 11.7	10.7 / 11.3
	IEER (Ducted/Non-Ducted)		24.3 / 30.7	23.3 / 29.2	22.3 / 26.3	22.2 / 26.4
	COP (Ducted/Non-Ducted)		3.60 / 3.88	3.49 / 3.82	3.36 / 3.56	3.28 / 3.50
	SCHE (Ducted/Non-Ducted)		23.0 / 28.0	22.7 / 26.9	22.9 / 26.8	22.3 / 25.7

NOTES:

Nominal cooling conditions (Test conditions are based on AHRI 1230) Indoor: 80°FDB./67°FWB. (26.7°CDB./19.4°CWB.), Outdoor: 95°FDB. (35°CDB.)

Nominal heating conditions (Test conditions are based on AHRI 1230) Indoor: 70°FDB. (21.1°CDB.), Outdoor: 47°FDB./43°FWB. (8.3°CDB./6.1°CWB.)

Twinning kit is required for combining multiple individual outdoor units in the field for TURYP*3(4)BN combined systems.

1. Harsh weather environments may demand performance enhancing equipment. Ask your Trane representative for more details about your region.

2. For details on extended cooling operation range down to -10° F DB, see Low Ambient Kit Submittal.

3. When applying product below -4°F, consult your design engineer for cold climate application best practices, including the use of a backup source for heating.

4. Unit will continue to operate in extended operating range, but capacity is not guaranteed.

5. Efficiency ratings are based on AHRI 1230 test method



TURYP** (3/4) BN40A

SPECIFICATIONS			MODEL NAMES		
VOLTAGES	208V /230V		TURYP2883BN40A(N/B)	TURYP3123BN40A(N/B)	TURYP3363BN40A(N/B)
		With 2 TURYP1443AN40A(N/B)	With 1 TURYP1963AN40A(N/B) and 1 TURYP1443AN40A(N/B)	With 2 TURYP1683AN40A(N/B)	
	460V	TURYP2884BN40A(N/B)	TURYP3124BN40A(N/B)	TURYP3364BN40A(N/B)	
		With 2 TURYP1444AN40A(N/B)	With 1 TURYP1684AN40A(N/B) and 1 TURYP1444AN40A(N/B)	With 2 TURYP1684AN40A(N/B)	
Power Source			3-phase 3-wire 208-230 V ±10% 60 Hz		
			3-phase 3-wire 460 V ±10% 60 Hz		
Capacity (Nominal)	Cooling	BTUH	288,000	312,000	336,000
	Heating	BTUH	323,000	350,000	378,000
Electrical Supply	MCA	A	Refer to: TURYP1443AN40A(N/B)	Refer to: TURYP1963AN40A(N/B) TURYP1443AN40A(N/B)	Refer to: TURYP1683AN40A(N/B)
	MOP	A			
	SCCR	A	TURYP1444AN40A(N/B)	TURYP1684AN40A(N/B) TURYP1444AN40A(N/B)	TURYP1684AN40A(N/B)
	Recommended Fuse Size	A			
Fan	Type X Quantity				
	Airflow Rate	CFM			
	External Static Pressure				
Compressor	Type X Quantity				
	Operating Range		7.5% to 100%	7.5% to 100%	7.5% to 100%
	Lubricant				
Refrigerant	Type		Refer to: TURYP1443AN40A(N/B)	Refer to: TURYP1963AN40A(N/B) TURYP1443AN40A(N/B)	Refer to: TURYP1683AN40A(N/B)
External Finish					
Dimensions	Height	In.			
	Width		TURYP1444AN40A(N/B)	TURYP1684AN40A(N/B)	TURYP1684AN40A(N/B)
	Depth		TURYP1444AN40A(N/B)	TURYP1684AN40A(N/B)	TURYP1684AN40A(N/B)
Net Weight		lbs.			
Sound Pressure Level (Measured in Anechoic Room)		dB(A)	68.0/68.5	67.0/69.0	65.5/69.5
Sound Power Level (Measured in Anechoic Room)		dB(A)	88.5/88.5W	87.0/88.5	84.0/88.5
Protection Devices	High Pressure		High pressure sensor, High pressure switch at 4.15 MPa (601 psi)		
	Inverter Circuit (Compressor/Fan)		Over-heat protection, Over-current protection		
Refrigerant Pipe Dimensions	Liquid (High Pressure) (Brazed)	In.	1-1/8 Brazed		
	Gas (Low Pressure) (Brazed)		1-3/8 Brazed	1-5/8 Brazed	1-5/8 Brazed
Indoor Unit Connectable	Total capacity		50-150% of outdoor unit capacity		
	Model / Quantity		P05-P96/2-50		
Guaranteed Operating Range *1	Cooling (Outdoor) *2		23-126°F (-5-52°C)		
	Heating (Outdoor) *3		-4-60°F (-20-15.5°C)		
Extended Operating Range *4	Heating (Outdoor)		-18-60°F (-28-15.5°C)		
Efficiency Ratings *5	EER (Ducted/Non-Ducted)		10.2 / 10.9	10.1 / 10.2	9.9 / 9.5
	IEER (Ducted/Non-Ducted)		22.1 / 26.4	21.4 / 24.6	20.5 / 23
	COP (Ducted/Non-Ducted)		3.20 / 3.44	3.20 / 3.36	3.2 / 3.29
	SCHE (Ducted/Non-Ducted)		21.7 / 24.5	20.6 / 23.8	20.4 / 23.4

NOTES:

Nominal cooling conditions (Test conditions are based on AHRI 1230) Indoor: 80°F DB./67°F WB. (26.7°C DB./19.4°C WB.), Outdoor: 95°F DB. (35°C DB.)

Nominal heating conditions (Test conditions are based on AHRI 1230) Indoor: 70°F DB. (21.1°C DB.), Outdoor: 47°F DB./43°F WB. (8.3°C DB./6.1°C WB.)

Twinning kit is required for combining multiple individual outdoor units in the field for TURYP*3(4)BN combined systems.

1. Harsh weather environments may demand performance enhancing equipment. Ask your

Trane representative for more details about your region.

2. For details on extended cooling operation range down to -10° F DB, see Low Ambient Kit Submittal.

3. When applying product below -4°F, consult your design engineer for cold climate application best practices, including the use of a backup source for heating.

4. Unit will continue to operate in extended operating range, but capacity is not guaranteed.

5. Efficiency ratings are based on AHRI 1230 test method



TURYE*** (3/4)AN40A

SPECIFICATIONS			MODEL NAMES				
VOLTAGES	208V /230V		TURYE0723AN40A(N/B)	TURYE0963AN40A(N/B)	TURYE1203AN40A(N/B)	TURYE1443AN40A(N/B)	TURYE1683AN40A(N/B)
	460V		TURYE0724AN40A(N/B)	TURYE0964AN40A(N/B)	TURYE1204AN40A(N/B)	TURYE1444AN40A(N/B)	TURYE1684AN40A(N/B)
Power Source			3-phase 3-wire 208-230 V ±10% 60 Hz				
			3-phase 3-wire 460 V ±10% 60 Hz				
Capacity (Nominal)	Cooling	BTUH	72,000	96,000	120,000	144,000	168,000
	Heating	BTUH	80,000	108,000	135,000	160,000	188,000
Electrical Supply	MCA	A	23/21	31/29	41/38	49/45	57/53
			10	14	19	22	26
	MOP	A	35/30	45/45	60/60	80/70	90/80
			15	20	30	35	40
	SCCR	A	5	5	5	5	5
Recommended Fuse Size	A	30/30	45/45	60/60	60/60	70/70	
Fan	Type X Quantity		Propeller fan x 1	Propeller fan x 2	Propeller fan x 2	Propeller fan x 2	Propeller fan x 2
	Airflow Rate	CFM	6,000	7,400	8,300	9,550	14,850
	External Static Pressure		Selectable; 0, 0.12, 0.24, 0.32 in.WG; factory set to 0 in.WG				
Compressor	Type X Quantity		Inverter scroll hermetic compressor x 1				
	Operating Range		15% to 100%	15% to 100%	15% to 100%	15% to 100%	15% to 100%
	Lubricant		MEL32				
Refrigerant	Type	R410A					
External Finish			Pre-coated galvanized steel sheet (+powder coating for -BS type) <MUNSELL 5Y 8/1>				
Dimensions	Height	In.	71-5/8				
	Width		36-1/4	48-7/8	48-7/8	48-7/8	68-29/32
	Depth		29-5/32				
Net Weight		lbs.	519	613	622	680	777
			552	649	657	715	807
Sound Pressure Level (Measured in Anechoic Room)		dB(A)	56.5/58.0	58.5/60.0	60.0/62.0	65.0/65.5	62.5/66.5
Sound Power Level (Measured in Anechoic Room)		dB(A)	75.5/77.0	77.5/79.0	80.0/80.5	85.5/85.5	81.0/85.5
Protection Devices	High Pressure		High pressure sensor, High pressure switch at 4.15 MPa (601 psi)				
	Inverter Circuit (Compressor/Fan)		Over-heat protection, Over-current protection				
Refrigerant Pipe Dimensions	Liquid (High Pressure) (Brazed)	In.	5/8 Brazed	3/4 Brazed	3/4 Brazed	7/8 Brazed	7/8 Brazed
	Gas (Low Pressure) (Brazed)		3/4 Brazed	7/8 Brazed	1-1/8 Brazed	1-1/8 Brazed	1-1/8 Brazed
Indoor Unit Connectable	Total capacity		50~150% of outdoor unit capacity				
	Model / Quantity		P05-P96/1-18	P05-P96/1-24	P05-P96/1-30	P05-P96/1-36	P05-P96/1-42
Guaranteed Operating Range *1	Cooling (Outdoor) *2		23~126°F (-5~52°C)				
	Heating (Outdoor) *3		-13F~60°F (-25~15.5°C)				
Extended Operating Range *4	Heating (Outdoor)		-25~60°F (-31.5~15.5°C)				
Efficiency Ratings *5	EER (Ducted/ Non-Ducted)		13.4 / 15.4	13.7 / 15.1	12.6 / 13.8	11.7 / 12.9	11.2 / 11.9
	IEER (Ducted/ Non-Ducted)		24.5 / 31.2	26.5 / 33.1	25.0 / 30.1	24.1 / 29.7	23.4 / 28.0
	COP (Ducted/ Non-Ducted)		3.81 / 4.37	3.94 / 4.26	3.71 / 4.04	3.49 / 3.86	3.30 / 3.80
	SCHE (Ducted/ Non-Ducted)		25.9 / 25.5	23.5 / 28.3	25.3 / 29.1	24.8 / 27.7	24.7 / 28.3

NOTES:

Nominal cooling conditions (Test conditions are based on AHRI 1230) Indoor: 80°FDB./67°FWB. (26.7°CDB./19.4°CWB.), Outdoor: 95°FDB. (35°CDB.)

Nominal heating conditions (Test conditions are based on AHRI 1230) Indoor: 70°FDB. (21.1°CDB.), Outdoor: 47°FDB./43°FWB. (8.3°CDB./6.1°CWB.)

1. Harsh weather environments may demand performance enhancing equipment. Ask your Trane representative for more details about your region.

2. For details on extended cooling operation range down to -10° F DB, see Low Ambient Kit Submittal.

3. When applying product below -4°F, consult your design engineer for cold climate application best practices, including the use of a backup source for heating.

4. Unit will continue to operate in extended operating range, but capacity is not guaranteed.

5. Efficiency ratings are based on AHRI 1230 test method



SPECIFICATIONS: ▼
R2-SERIES (HIGH-EFFICIENCY)

TURYE* (3/4)BN40A**

SPECIFICATIONS			MODEL NAMES			
VOLTAGES	208V / 230V		TURYE1923BN40A(N/B)	TURYE2163BN40A(N/B)	TURYE2403BN40A(N/B)	TURYE2643BN40A(N/B)
		With 2 TURYE0963AN40A(N/B)	With 1 TURYE1203AN40A(N/B) and 1 TURYE0963AN40A(N/B)	With 2 TURYE1203AN40A(N/B)	With 1 TURYE1443AN40A(N/B) and 1 TURYE1203AN40A(N/B)	
	460V		TURYE1924BN40A(N/B)	TURYE2164BN40A(N/B)	TURYE2404BN40A(N/B)	TURYE2644BN40A(N/B)
		With 2 TURYE0964AN40A(N/B)	With 1 TURYE1204AN40A(N/B) and 1 TURYE0964AN40A(N/B)	With 2 TURYE1204AN40A(N/B)	With 1 TURYE1444AN40A(N/B) and 1 TURYE1204AN40A(N/B)	
Power Source			3-phase 3-wire 208-230 V ±10% 60 Hz 3-phase 3-wire 460 V ±10% 60 Hz			
Capacity (Nominal)	Cooling	BTUH	192,000	216,000	240,000	264,000
	Heating	BTUH	215,000	243,000	270,000	295,000
Electrical Supply	MCA	A	Refer to: TURYE0963AN40A(N/B)	Refer to: TURYE1203AN40A(N/B) TURYE0963AN40A(N/B)	Refer to: TURYE1203AN40A(N/B)	Refer to: TURYE1443AN40A(N/B) TURYE1203AN40A(N/B)
	MOP	A				
	SCCR	A	TURYE0964AN40A(N/B)	TURYE1204AN40A(N/B) TURYE0964AN40A(N/B)	TURYE1204AN40A(N/B)	TURYE1444AN40A(N/B) TURYE1204AN40A(N/B)
	Recommended Fuse Size	A				
Fan	Type X Quantity					
	Airflow Rate	CFM				
	External Static Pressure					
Compressor	Type X Quantity					
	Operating Range		7.5% to 100%			
Refrigerant	Lubricant		Refer to: TURYE0963AN40A(N/B)	Refer to: TURYE1203AN40A(N/B) TURYE0963AN40A(N/B)	Refer to: TURYE1203AN40A(N/B)	Refer to: TURYE1443AN40A(N/B) TURYE1203AN40A(N/B)
Refrigerant	Type					
External Finish						
Dimensions	Height	In.	TURYE0964AN40A(N/B)	TURYE1204AN40A(N/B) TURYE0964AN40A(N/B)	TURYE1204AN40A(N/B)	TURYE1444AN40A(N/B) TURYE1204AN40A(N/B)
	Width					
	Depth					
Net Weight		lbs.				
Sound Pressure Level (Measured in Anechoic Room)		dB(A)	61.5/63.0	62.5/64.5	63.0/65.0	66.5/67.5
Sound Power Level (Measured in Anechoic Room)		dB(A)	80.5/82.0	82.0/83.0	83.0/83.5	87.0/87.0
Protection Devices	High Pressure		High pressure sensor, High pressure switch at 4.15 MPa (601 psi)			
	Inverter Circuit (Compressor/Fan)		Over-heat protection, Over-current protection			
Refrigerant Pipe Dimensions	Liquid (High Pressure) (Brazed)	In.	7/8 Brazed	7/8 Brazed (1-1/8 Brazed for the part that exceeds 65 m)	7/8 Brazed (1-1/8 Brazed for the part that exceeds 65 m)	1-1/8 Brazed
	Gas (Low Pressure) (Brazed)		1-1/8 Brazed	1-1/8 Brazed	1-3/8 Brazed	1-3/8 Brazed
Indoor Unit Connectable	Total capacity		50-150% of outdoor unit capacity			
	Model / Quantity		P05-P96/1-48	P05-P96/2-50	P05-P96/2-50	P05-P96/2-50
Guaranteed Operating Range *1	Cooling (Outdoor) *2		23-126°F (-5-52°C)			
	Heating (Outdoor) *3		-13F-60°F (-25-15.5°C)			
Extended Operating Range *4	Heating (Outdoor)		-25-60°F (-31.5-15.5°C)			
Efficiency Ratings *5	EER (Ducted/Non-Ducted)		12.7 / 14.1	12.2 / 13.5	11.7 / 12.2	11.3 / 11.9
	IEER (Ducted/Non-Ducted)		25.3 / 31.8	24.6 / 30.4	23.9 / 27.4	23.5 / 27.4
	COP (Ducted/Non-Ducted)		3.66 / 3.99	3.56 / 3.89	3.46 / 3.58	3.36 / 3.53
	SCHE (Ducted/Non-Ducted)		23.0 / 28.0	22.7 / 26.9	22.9 / 26.8	22.3 / 25.7

NOTES:

Nominal cooling conditions (Test conditions are based on AHRI 1230) Indoor: 80°FDB./67°FWB. (26.7°CDB./19.4°CWB.), Outdoor: 95°FDB. (35°CDB.)

Nominal heating conditions (Test conditions are based on AHRI 1230) Indoor: 70°FDB. (21.1°CDB.), Outdoor: 47°FDB./43°FWB. (8.3°CDB./6.1°CWB.)

Twinning kit is required for combining multiple individual outdoor units in the field for TURYE*3(4)BN combined systems.

1. Harsh weather environments may demand performance enhancing equipment. Ask your Trane representative for more details about your region.

2. For details on extended cooling operation range down to -10° F DB, see Low Ambient Kit Submittal.

3. When applying product below -4°F, consult your design engineer for cold climate application best practices, including the use of a backup source for heating.

4. Unit will continue to operate in extended operating range, but capacity is not guaranteed.

5. Efficiency ratings are based on AHRI 1230 test method



TURYE*** (3/4)BN40A

SPECIFICATIONS			MODEL NAMES			
VOLTAGES	208V /230V		TURYE2883BN40A(N/B) With 2 TURYE1443AN40A(N/B)	TURYE3123BN40A(N/B) With 1 TURYE1683AN40A(N/B) and 1 TURYE1443AN40A(N/B)	TURYE3364BN40A(N/B) With 2 TURYE1683AN40A(N/B)	
	460V		TURYE2884BN40A(N/B) With 2 TURYE1444AN40A(N/B)	TURYE3124BN40A(N/B) With 1 TURYE1684AN40A(N/B) and 1 TURYE1444AN40A(N/B)	TURYE3364BN40A(N/B) With 2 TURYE1684AN40A(N/B)	
Power Source			3-phase 3-wire 208-230 V ±10% 60 Hz 3-phase 3-wire 460 V ±10% 60 Hz			
Capacity (Nominal)	Cooling	BTUH	288,000	312,000	336,000	
	Heating	BTUH	323,000	350,000	378,000	
Electrical Supply	MCA	A	Refer to: TURYE1443AN40A(N/B)	Refer to: TURYE1683AN40A(N/B) TURYE1443AN40A(N/B)	Refer to: TURYE1683AN40A(N/B)	
	MOP	A				
	SCCR	A	TURYE1444AN40A(N/B)	TURYE1684AN40A(N/B) TURYE1444AN40A(N/B)	TURYE1684AN40A(N/B)	
	Recommended Fuse Size	A				
Fan	Type X Quantity					
	Airflow Rate	CFM				
	External Static Pressure					
Compressor	Type X Quantity					
	Operating Range		7.5% to 100%			
	Lubricant		Refer to: TURYE1443AN40A(N/B)	Refer to: TURYE1683AN40A(N/B) TURYE1443AN40A(N/B)	Refer to: TURYE1683AN40A(N/B)	
Refrigerant	Type					
External Finish						
Dimensions	Height	In.				
	Width		TURYE1444AN40A(N/B)	TURYE1684AN40A(N/B) TURYE1444AN40A(N/B)	TURYE1684AN40A(N/B)	
	Depth					
Net Weight			lbs.			
Sound Pressure Level (Measured in Anechoic Room)			dB(A)	68.0/68.5	67.0/69.0	65.5/69.5
Sound Power Level (Measured in Anechoic Room)			dB(A)	88.5/88.5	87.0/88.5	84.0/88.5
Protection Devices	High Pressure		High pressure sensor, High pressure switch at 4.15 MPa (601 psi)			
	Inverter Circuit (Compressor/Fan)		Over-heat protection, Over-current protection			
Refrigerant Pipe Dimensions	Liquid (High Pressure) (Brazed)	In.	1-1/8 Brazed			
	Gas (Low Pressure) (Brazed)		1-3/8 Brazed	1-5/8 Brazed	1-5/8 Brazed	
Indoor Unit Connectable	Total capacity		50-150% of outdoor unit capacity			
	Model / Quantity		P05-P96/2-50			
Guaranteed Operating Range *1	Cooling (Outdoor) *2		23-126°F (-5-52°C)			
	Heating (Outdoor) *3		-13F-60°F (-25-15.5°C)			
Extended Operating Range *4	Heating (Outdoor)		-25-60°F (-31.5-15.5°C)			
Efficiency Ratings *5	EER (Ducted/Non-Ducted)		10.9 / 11.5	10.7 / 10.9	10.5 / 10.3	
	IEER (Ducted/Non-Ducted)		23.1 / 27.4	22.8 / 26.1	22.5 / 24.9	
	COP (Ducted/Non-Ducted)		3.26 / 3.46	3.24 / 3.37	3.22 / 3.29	
	SCHE (Ducted/Non-Ducted)		21.7 / 24.5	20.6 / 23.8	20.4 / 23.4	

NOTES:

Nominal cooling conditions (Test conditions are based on AHRI 1230) Indoor: 80°F D.B./67°F W.B. (26.7°C D.B./19.4°C W.B.), Outdoor: 95°F D.B. (35°C D.B.)

Nominal heating conditions (Test conditions are based on AHRI 1230) Indoor: 70°F D.B. (21.1°C D.B.), Outdoor: 47°F D.B./43°F W.B. (8.3°C D.B./6.1°C W.B.)

Twinning kit is required for combining multiple individual outdoor units in the field for TURYE*3(4)BN combined systems.

1. Harsh weather environments may demand performance enhancing equipment. Ask your Trane representative for more details about your region.

2. For details on extended cooling operation range down to -10° F DB, see Low Ambient Kit Submittal.

3. When applying product below -4°F, consult your design engineer for cold climate application best practices, including the use of a backup source for heating.

4. Unit will continue to operate in extended operating range, but capacity is not guaranteed.

5. Efficiency ratings are based on AHRI 1230 test method



TURYH* (3/4)AN40AN**

SPECIFICATION			MODEL NAMES		
VOLTAGES	208V /230V		TURYH0723AN40AN	TURYH0963AN40AN	TURYH1203AN40AN
	460V		TURYH0724AN40AN	TURYH0964AN40AN	TURYH1204AN40AN
Power Source			3-phase 3-wire 208-230 V ±10% 60 Hz		
			3-phase 3-wire 460 V ±10% 60 Hz		
Capacity (Nominal)	Cooling	BTUH	72,000	96,000	120,000
	Heating	BTUH	80,000	108,000	135,000
Electrical Supply	MCA	A	38/35	44/40	47/44
			17	20	21
	MOP	A	60/50	70/60	70/60
			25	30	35
	SCCR	A	5	5	5
	Recommended Fuse Size	A	60/50	70/60	70/60
25			30	35	
Fan	Type X Quantity		Propeller fan x 2	Propeller fan x 2	Propeller fan x 2
	Airflow Rate	CFM	7,400	8,300	9,550
	External Static Pressure		Selectable; 0, 0.12, 0.24, 0.32 in.WG; factory set to 0 in.WG		
Compressor	Type X Quantity		Inverter scroll hermetic compressor x 1		
	Operating Range		15% to 100%	15% to 100%	15% to 100%
	Lubricant		MEL46		
Refrigerant	Type		R410A		
External Finish			Pre-coated galvanized steel sheet <MUNSELL 5Y 8/1>		
Dimensions	Height	In.	71-5/8		
	Width	In.	48-7/8		
	Depth	In.	29-3/16		
Net Weight		lbs.	609	662	662
			644	697	697
Sound Pressure Level (Measured in Anechoic Room)		dB(A)	56.5/58.0	58.5/60.0	64.0/65.0
Sound Power Level (Measured in Anechoic Room)		dB(A)	75.5/77.0	77.5/79.0	84.0/85.0
Protection Devices	High Pressure		Over-heat protection, Over-current protection		
	Inverter Circuit (Compressor/Fan)		Over-current protection		
Refrigerant Pipe Dimensions	Liquid (High Pressure) (Braze)		5/8 Braze	3/4 Braze	3/4 Braze
	Gas (Low Pressure) (Braze)		3/4 Braze	7/8 Braze	1-1/8 Braze
Indoor Unit Connectable	Total capacity		50-150% of outdoor unit capacity		
	Model / Quantity		P05-P96/1-18	P05-P96/1-24	P05-P96/1-30
Guaranteed Operating Range *1	Cooling (Outdoor) *2		23-126°F (-5-52°C)		
	Heating (Outdoor) *3		-22-60°F (-30-15.5°C)		
Extended Operating Range *4	Heating (Outdoor)		-31-60°F (-35-15.5°C)		
Efficiency Ratings *5	EER (Ducted/Non-Ducted)		11.9 / 13.1	12.8 / 14.5	12.1 / 13.2
	IEER (Ducted/Non-Ducted)		20.9 / 25.6	19.8 / 26.6	19.7 / 24.4
	COP (Ducted/Non-Ducted)		3.76 / 4.09	3.88 / 4.14	3.61 / 4.01
	SCHE (Ducted/Non-Ducted)		25.9 / 25.5	23.5 / 28.3	25.3 / 29.1

NOTES:

Nominal cooling conditions (Test conditions are based on AHRI 1230) Indoor: 80°FDB./67°FWB. (26.7°CDB./19.4°CWB.), Outdoor: 95°FDB. (35°CDB.)

Nominal heating conditions (Test conditions are based on AHRI 1230) Indoor: 70°FDB. (21.1°CDB.), Outdoor: 47°FDB./43°FWB. (8.3°CDB./6.1°CWB.)

1. Harsh weather environments may demand performance enhancing equipment. Ask your Trane representative for more details about your region.

2. For details on extended cooling operation range down to -10° F DB, see Low Ambient Kit Submittal.

3. When applying product below -4°F, consult your design engineer for cold climate application best practices, including the use of a backup source for heating.

4. Unit will continue to operate in extended operating range, but capacity is not guaranteed.

5. Efficiency ratings are based on AHRI 1230 test method



TURYH* (3/4)BN40AN**

SPECIFICATION			MODEL NAMES		
VOLTAGES	208V /230V		TURYH1443BN40AN	TURYH1923BN40AN	TURYH2403BN40AN
		With 2 TURYH0723AN40AN	With 2 TURYH0963AN40AN	With 2 TURYH1203AN40AN	
	460V		TURYH1444BN40AN	TURYH1924BN40AN	TURYH2404BN40AN
		With 2 TURYH0724AN40AN	With 2 TURYH0964AN40AN	With 2 TURYH1204AN40AN	
Power Source			3-phase 3-wire 208-230 V ±10% 60 Hz		
			3-phase 3-wire 460 V ±10% 60 Hz		
Capacity (Nominal)	Cooling	BTUH	144,000	192,000	240,000
	Heating	BTUH	160,000	215,000	270,000
Electrical Supply	MCA	A	Refer to: TURYH0723AN40AN	Refer to: TURYH0963AN40AN	Refer to: TURYH1203AN40AN
	MOP	A			
	SCCR	A	TURYH0724AN40AN	TURYH0964AN40AN	TURYH1204AN40AN
	Recommended Fuse Size	A			
Fan	Type X Quantity				
	Airflow Rate	CFM			
	External Static Pressure				
Compressor	Type X Quantity				
	Operating Range		7.5% to 100%	7.5% to 100%	7.5% to 100%
	Lubricant		Refer to: TURYH0723AN40AN	Refer to: TURYH0963AN40AN	Refer to: TURYH1203AN40AN
Refrigerant	Type	TURYH0723AN40AN	TURYH0963AN40AN	TURYH1203AN40AN	
External Finish					
Dimensions	Height	In.			
	Width	In.	TURYH0724AN40AN	TURYH0964AN40AN	TURYH1204AN40AN
	Depth	In.			
Net Weight		lbs.			
Sound Pressure Level (Measured in Anechoic Room)		dB(A)	59.5/61.0	61.5/63.0	67.0/68.0
Sound Power Level (Measured in Anechoic Room)		dB(A)	78.5/80.0	80.5/82.0	87.0/88.0
Protection Devices	High Pressure		Over-heat protection, Over-current protection		
	Inverter Circuit (Compressor/Fan)		Over-current protection		
Refrigerant Pipe Dimensions	Liquid (High Pressure) (Brazed)		7/8 Brazed	7/8 Brazed	7/8 Brazed (1-1/8 Brazed for the part that exceeds 65 m)
	Gas (Low Pressure) (Brazed)		1-1/8 Brazed	1-1/8 Brazed	1-3/8 Brazed
Indoor Unit Connectable	Total capacity		50-150% of outdoor unit capacity		
	Model / Quantity		P05-P96/1-36	P05-P96/1-48	P05-P96/2-50
Guaranteed Operating Range *1	Cooling (Outdoor) *2		23-126°F (-5-52°C)		
	Heating (Outdoor) *3		-22-60°F (-30-15.5°C)		
Extended Operating Range *4	Heating (Outdoor)		-31-60°F (-35-15.5°C)		
Efficiency Ratings *5	EER (Ducted/Non-Ducted)		10.9 / 12.2	11.9 / 13.5	11.2 / 11.7
	IEER (Ducted/Non-Ducted)		19.7 / 24.5	18.9 / 25.6	18.8 / 22.2
	COP (Ducted/Non-Ducted)		3.45 / 3.82	3.6 / 3.88	3.36 / 3.56
	SCHE (Ducted/Non-Ducted)		24.8 / 27.7	23 / 28	22.9 / 26.8

NOTES:

Nominal cooling conditions (Test conditions are based on AHRI 1230) Indoor: 80°FDB./67°FWB. (26.7°CDB./19.4°CWB.), Outdoor: 95°FDB. (35°CDB.)

Nominal heating conditions (Test conditions are based on AHRI 1230) Indoor: 70°FDB. (21.1°CDB.), Outdoor: 47°FDB./43°FWB. (8.3°CDB./6.1°CWB.)

Twinning kit is required for combining multiple individual outdoor units in the field for TURYH*3(4)BN combined systems.

1. Harsh weather environments may demand performance enhancing equipment. Ask your Trane representative for more details about your region.

2. For details on extended cooling operation range down to -10° F DB, see Low Ambient Kit Submittal.

3. When applying product below -4°F, consult your design engineer for cold climate application best practices, including the use of a backup source for heating.

4. Unit will continue to operate in extended operating range, but capacity is not guaranteed.

5. Efficiency ratings are based on AHRI 1230 test method

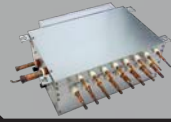

TCMBG***SJ11N4

SPECIFICATIONS			MODEL NAMES				
			TCMBG0104SJ11N4	TCMBG0106SJ11N4	TCMBG0108SJ11N4	TCMBG0102SJ11N4	TCMBG0106SJ11N4
Number of Branches			4	6	8	12	16
Power Source			208 / 230V, 1 phase, 60Hz				
Power Input (208/230V)	Cooling	kW	0.061 / 0.078	0.091 / 0.118	0.122 / 0.157	0.182 / 0.235	0.243 / 0.314
	Heating	kW	0.030 / 0.039	0.046 / 0.059	0.061 / 0.078	0.091 / 0.118	0.122 / 0.157
Current (208/230V)	Cooling	A	0.30 / 0.35	0.44 / 0.52	0.59 / 0.69	0.88 / 1.03	1.17 / 1.37
	Heating	A	0.15 / 0.18	0.22 / 0.26	0.30 / 0.35	0.44 / 0.52	0.59 / 0.69
External Finish			Galvanized steel plate (Lower part drain pan: Pre-coated galvanized sheets + powder coating)				
Dimensions	Height	In.	9-7/8				
	Width		23-1/2	23-1/2	23-1/2	35-7/8	44-11/16
	Depth		15-11/16	15-11/16	15-11/16	21-1/2	21-1/2
Net Weight		Lbs.	58	64	73	109	131
Refrigerant Pipe Dimensions	To Indoor Unit	Liquid Pipe (In.)	3/8				
		Gas Pipe (In.)	5/8				
Connectable Outdoor/ Heat Source Unit Capacity		BTUH	72,000 to 120,000				
Indoor unit Capacity Connectable to One Branch			54,000				
Drain Pipe			3/4 NPT				
Sound Power Level (Measured in Anechoic Room)	Rated Operation dB(A)		59				
	Defrost dB(A)		71				
Sound Pressure Level (Measured in Anechoic Room)	Rated Operation dB(A)		40				
	Defrost dB(A)		53				

Total Downstream Capacity (Nominal cooling) (BTUH)	Liquid (High Pressure)	Gas (Low Pressure)	Liquid Pipe
Less than 72,000	5/8 (Brazed)	3/4 (Brazed)	3/8 (Brazed)
Between 73,000 and 108,000	3/4 (Brazed)	7/8 (Brazed)	3/8 (Brazed)
Between 109,000 and 126,000	3/4 (Brazed)	1-1/8 (Brazed)	1/2 (Brazed)
Between 127,000 and 144,000	7/8 (Brazed)	1-1/8 (Brazed)	1/2 (Brazed)
Between 145,000 and 216,000	7/8 (Brazed)	1-1/8 (Brazed)	5/8 (Brazed)
Between 217,000 and 234,000	1-1/8 (Brazed)	1-1/8 (Brazed)	5/8 (Brazed)
Between 235,000 and 288,000	1-1/8 (Brazed)	1-3/8 (Brazed)	3/4 (Brazed)
Between 289,000 and 360,000	1-1/8 (Brazed)	1-5/8 (Brazed)	3/4 (Brazed)
Greater than 361,000	1-3/8 (Brazed)	1-5/8 (Brazed)	3/4 (Brazed)



TCMBM* (JA/KA)11N4**

SPECIFICATIONS			MODEL NAMES			
			TCMBM0108JA11N4	TCMBM0102JA11N4	TCMBM0106JA11N4	TCMBM0106KA11N4
Number of Branches			8	12	16	16
Power Source			208 / 230V, 1 phase, 60Hz			
Power Input (208/230V)	Cooling	kW	0.137 / 0.176	0.198 / 0.255	0.258 / 0.333	0.258 / 0.333
	Heating	kW	0.076 / 0.098	0.106 / 0.137	0.137 / 0.176	0.137 / 0.176
Current (208/230V)	Cooling	A	0.66 / 0.77	0.95 / 0.11	1.25 / 1.45	1.25 / 1.45
	Heating	A	0.37 / 0.43	0.52 / 0.60	0.66 / 0.77	0.66 / 0.77
External Finish			Galvanized steel plate (Lower part drain pan: Pre-coated galvanized sheets + powder coating)			
Dimensions	Height	In.	9-7/8			
	Width		35-7/8	44-11/16	44-11/16	44-11/16
	Depth		21-1/2			
Net Weight		Lbs.	106	133	150	153
Refrigerant Pipe Dimensions	To Indoor Unit	Liquid Pipe (In.)	3/8			
		Gas Pipe (In.)	5/8			
Connectable Outdoor / Heat Source Unit Capacity		BTUH	72,000 to 336,000			72,000 to 432,000
Max. Connected Capacity to Sub BC Controllers		BTUH	126,000			
Indoor unit Capacity Connectable to One Branch			54,000			
Drain Pipe			3/4 NPT			
Sound Power Level (Measured in Anechoic Room)	Rated Operation dB(A)		68			66
	Defrost dB(A)		74			73
Sound Pressure Level (Measured in Anechoic Room)	Rated Operation dB(A)		50			48
	Defrost dB(A)		56			55



TCMBS* (KB)11N4**

SPECIFICATIONS			MODEL NAMES	
			TCMBS0104KB11N4	TCMBS0108KB11N4
Number of Branches			4	8
Power Source			208 / 230V, 1 phase, 60Hz	
Power Input (208/230V)	Cooling	kW	0.061 / 0.078	0.122 / 0.157
	Heating	kW	0.030 / 0.039	0.061 / 0.078
Current (208/230V)	Cooling	A	0.30 / 0.35	0.59 / 0.69
	Heating	A	0.15 / 0.18	0.30 / 0.35
External Finish			Galvanized steel plate (Lower part drain pan: Pre-coated galvanized sheets + powder coating)	
Dimensions	Height	In.	9-7/8	
	Width	In.	23-1/2	
	Depth	In.	15-11/16	
Net Weight		Lbs.	51	69
Refrigerant Pipe Dimensions	To Indoor Unit	Liquid Pipe (In.)	3/8	
		Gas Pipe (In.)	5/8	
Maximum Connectable Sub BC Controllers			11	
Max. Connected Capacity for All Branches		BTUH	126,000	
Indoor unit Capacity Connectable to One Branch			54,000	
Drain Pipe			3/4 NPT	
Sound Power Level (Measured in Anechoic Room)	Rated Operation dB(A)		59	
	Defrost dB(A)		71	
Sound Pressure Level (Measured in Anechoic Room)	Rated Operation dB(A)		40	
	Defrost dB(A)		53	



SPECIFICATIONS: ▼
Y-SERIES (STANDARD-EFFICIENCY)

TUHYP* (3/4)AN40A**

SPECIFICATIONS			MODEL NAME				
VOLTAGES	208V /230V		TUHYP0723AN40A(N/B)	TUHYP0963AN40A(N/B)	TUHYP1203AN40A(N/B)	TUHYP1443AN40A(N/B)	TUHYP1683AN40A(N/B)
	460V		TUHYP0724AN40A(N/B)	TUHYP0964AN40A(N/B)	TUHYP1204AN40A(N/B)	TUHYP1444AN40A(N/B)	TUHYP1684AN40A(N/B)
Power Source			3-phase 3-wire 208-230 V ±10% 60 Hz				
			3-phase 3-wire 460 V ±10% 60 Hz				
Capacity (Nominal)	Cooling	BTUH	72,000	96,000	120,000	144,000	168,000
	Heating	BTUH	80,000	108,000	135,000	160,000	188,000
Electrical Supply	MCA	A	24/22	33/31	41/38	49/45	59/54
			11	15	19	22	27
	MOP	A	40/35	50/45	60/60	80/70	90/90
			15	20	30	35	45
	SCCR	A	5	5	5	5	5
Recommended Fuse Size	A	30/30	40/40	50/50	60/60	70/70	
Fan	Type X Quantity		Propeller fan x 1	Propeller fan x 2	Propeller fan x 2	Propeller fan x 2	Propeller fan x 2
	Airflow Rate	CFM	6,000	6,700	7,750	9,200	10,600
	External Static Pressure		Selectable; 0, 0.12, 0.24, 0.32 in.WG; factory set to 0 in.WG				
Compressor	Type X Quantity		Inverter scroll hermetic compressor x 1				
	Operating Range		15% to 100%	15% to 100%	15% to 100%	15% to 100%	15% to 100%
	Lubricant		MEL32				
Refrigerant	Type		R410A				
External Finish			Pre-coated galvanized steel sheet (+powder coating for -BS type) <MUNSELL 3Y 7.8/1.1 or similar>				
Dimensions	Height		71-10/16				
	Width	In.	36-4/16	48-14/16	48-14/16	68-15/16	
	Depth		29-3/1	29-3/16	29-3/16	29-3/16	
Net Weight		lbs.	479	569	594	640	713
			512	605	629	675	748
Sound Pressure Level (Measured in Anechoic Room)		dB(A)	55.0/57.5	56.5/58.5	60.0/62.0	62.5/65.0	60.5/64.5
Sound Power Level (Measured in Anechoic Room)		dB(A)	74.0/76.5	75.5/77.5	80.0/81.0	83.0/84.0	79.0/83.5
Protection Devices	High Pressure		High pressure sensor, High pressure switch at 4.15 MPa (601 psi)				
	Inverter Circuit (Compressor/Fan)		Over-current protection				
Refrigerant Pipe Dimensions	Liquid (High Pressure) (Brazed)	In.	3/8 Brazed	3/8 Brazed (1/2 Brazed, the farthest pipe length >= 90 m)	3/8 Brazed (1/2 Brazed, the farthest pipe length >= 40 m)	1/2 Brazed	5/8 Brazed
	Gas (Low Pressure) (Brazed)		7/8 Brazed	7/8 Brazed	1-1/8 Brazed	1-1/8 Brazed	1-1/8 Brazed
Indoor Unit Connectable	Total capacity		50-130% of outdoor unit capacity				
	Model / Quantity		P05-P72/1-15	P05-P96/1-20	P05-P96/1-26	P05-P96/1-31	P05-P96/1-36
Guaranteed Operating Range *1	Cooling (Outdoor) *2		23-126°F (-5-52°C)				
	Heating (Outdoor) *3		-4-60°F (-20-15.5°C)				
Extended Operating Range *4	Heating (Outdoor)		-18-60°F (-28-15.5°C)				
Efficiency Ratings *5	EER (Ducted/ Non-Ducted)		13.1 / 13.5	13.4 / 14.6	12.3 / 13.3	12.2 / 12.6	11.2 / 11.7
	IEER (Ducted/ Non-Ducted)		24.8 / 31.5	26.2 / 32.6	23.6 / 28.8	23.2 / 29.6	23.4 / 29.8
	COP (Ducted/ Non-Ducted)		3.97 / 4.34	3.98 / 4.34	3.70 / 4.05	3.57 / 3.90	3.59 / 4.02

NOTES:

Nominal cooling conditions (Test conditions are based on AHRI 1230) Indoor: 80°FDB./67°FWB. (26.7°CDB./19.4°CWB.), Outdoor: 95°FDB. (35°CDB.)

Nominal heating conditions (Test conditions are based on AHRI 1230) Indoor: 70°FDB. (21.1°CDB.), Outdoor: 47°FDB./43°FWB. (8.3°CDB./6.1°CWB.)

1. Harsh weather environments may demand performance enhancing equipment. Ask your Trane representative for more details about your region.

2. For details on extended cooling operation range down to -10° F DB, see Low Ambient Kit Submittal.

3. When applying product below -4°F, consult your design engineer for cold climate application best practices, including the use of a backup source for heating.

4. Unit will continue to operate in extended operating range, but capacity is not guaranteed.

5. Efficiency ratings are based on AHRI 1230 test method



TUHYP* (3/4)BN40A**

SPECIFICATIONS			MODEL NAMES				
VOLTAGES	208V /230V		TUHYP1923BN40A(N/B)	TUHYP2163BN40A(N/B)	TUHYP2403BN40A(N/B)	TUHYP2643BN40A(N/B)	TUHYP2883BN40A(N/B)
		With 2 TUHYP0963AN40A(N/B)	With 1 TUHYP1203AN40A(N/B) and 1 TUHYP0963AN40A(N/B)	With 2 TUHYP1203AN40A(N/B)	With 2 TUHYP0963AN40A(N/B) and 1 TUHYP0723AN40A(N/B)	With TUHYP1203AN40A(N/B) and TUHYP0963AN40A(N/B) and TUHYP0723AN40A(N/B)	
	460V		TUHYP1924BN40A(N/B)	TUHYP2164BN40A(N/B)	TUHYP2404BN40A(N/B)	TUHYP2644BN40A(N/B)	TUHYP2884BN40A(N/B)
		With 2 TUHYP0964AN40A(N/B)	With 1 TUHYP1204AN40A(N/B) and 1 TUHYP0964AN40A(N/B)	With 2 TUHYP1204AN40A(N/B)	With 2 TUHYP0964AN40A(N/B) and 1 TUHYP0724AN40A(N/B)	With TUHYP1204AN40A(N/B) and TUHYP0964AN40A(N/B) and TUHYP0724AN40A(N/B)	
Power Source			3-phase 3-wire 208-230 V ±10% 60 Hz				
			3-phase 3-wire 460 V ±10% 60 Hz				
Capacity (Nominal)	Cooling	BTUH	192,000	216,000	240,000	264,000	288,000
	Heating	BTUH	216,000	243,000	270,000	296,000	323,000
Electrical Supply	MCA	A	Refer to: TUHYP0963AN40A(N/B)	Refer to: TUHYP1203AN40A(N/B)	Refer to: TUHYP1203AN40A(N/B)	Refer to: TUHYP0963AN40A(N/B)	Refer to: TUHYP1203AN40A(N/B)
	MOP	A		TUHYP0963AN40A(N/B)		TUHYP0723AN40A(N/B)	TUHYP0963AN40A(N/B)
	SCCR	A					TUHYP0723AN40A(N/B)
	Recommended Fuse Size	A	TUHYP0964AN40A(N/B)	TUHYP1204AN40A(N/B) and TUHYP0964AN40A(N/B)	TUHYP1204AN40A(N/B)	TUHYP0964AN40A(N/B) and TUHYP0724AN40A(N/B)	TUHYP1204AN40A(N/B) and TUHYP0964AN40A(N/B) and TUHYP0724AN40A(N/B)
Fan	Type X Quantity						
	Airflow Rate	CFM					
	External Static Pressure						
Compressor	Type X Quantity						
	Operating Range		7.5% to 100%	7.5% to 100%	7.5% to 100%	5% to 100%	5% to 100%
	Lubricant		Refer to:	Refer to:	Refer to:	Refer to:	Refer to:
Refrigerant	Type		TUHYP0963AN40A(N/B)	TUHYP1203AN40A(N/B)	TUHYP1203AN40A(N/B)	TUHYP0963AN40A(N/B)	TUHYP1203AN40A(N/B)
External Finish				TUHYP0963AN40A(N/B)		TUHYP0723AN40A(N/B)	TUHYP0963AN40A(N/B)
Dimensions	Height	In.					
	Width						
	Depth		TUHYP0964AN40A(N/B)	TUHYP1204AN40A(N/B) and 1 TUHYP0964AN40A(N/B)	TUHYP1204AN40A(N/B)	TUHYP0964AN40A(N/B) and TUHYP0724AN40A(N/B)	TUHYP1204AN40A(N/B) and TUHYP0964AN40A(N/B) and TUHYP0724AN40A(N/B)
Net Weight		lbs.					
Sound Pressure Level (Measured in Anechoic Room)		dB(A)	60.0/62.0	62.0/64.0	63.5/65.5	61.0/63.0	62.5/65.0
Sound Power Level (Measured in Anechoic Room)		dB(A)	79.0/81.0	81.5/83.0	83.5/84.5	80.0/82.0	82.5/84.0
Protection Devices	High Pressure		High pressure sensor, High pressure switch at 4.15 MPa (601 psi)				
	Inverter Circuit (Compressor/Fan)		Over-current protection				
Refrigerant Pipe Dimensions	Liquid (High Pressure) (Brazed)	In.	5/8 Brazed	5/8 Brazed	5/8 Brazed	3/4 Brazed	3/4 Brazed
	Gas (Low Pressure) (Brazed)		1-1/8 Brazed	1-1/8 Brazed	1-1/8 Brazed	1-3/8 Brazed	1-3/8 Brazed
Indoor Unit Connectable	Total capacity		50-130% of outdoor unit capacity				
	Model / Quantity		P05-P96/1-41	P05-P96/2-46	P05-P96/2-50	P05-P96/2-50	P05-P96/2-50
Guaranteed Operating Range *1	Cooling (Outdoor) *2		23-126°F (-5-52°C)				
	Heating (Outdoor) *3		-4-60°F (-20-15.5°C)				
Extended Operating Range *4	Heating (Outdoor)		-18-60°F (-28-15.5°C)				
Efficiency Ratings *5	EER (Ducted/Non-Ducted)		12.4 / 13.6	11.9 / 13.0	11.4 / 11.8	12.2 / 12.6	11.9 / 12.2
	IEER (Ducted/Non-Ducted)		25.0 / 31.3	23.8 / 29.5	22.6 / 26.3	24.3 / 29.3	23.5 / 28.3
	COP (Ducted/Non-Ducted)		3.70 / 4.06	3.57 / 3.93	3.45 / 3.59	3.66 / 3.84	3.58 / 3.78

NOTES:

Nominal cooling conditions (Test conditions are based on AHRI 1230) Indoor: 80°F D.B./67°F W.B. (26.7°C D.B./19.4°C W.B.), Outdoor: 95°F D.B. (35°C D.B.)

Nominal heating conditions (Test conditions are based on AHRI 1230) Indoor: 70°F D.B. (21.1°C D.B.), Outdoor: 47°F D.B./43°F W.B. (8.3°C D.B./6.1°C W.B.)

Twinning kit is required for combining multiple individual

outdoor units in the field for TUHYP*** (3/4)BN combined systems.

1. Harsh weather environments may demand performance enhancing equipment. Ask your Trane representative for more details about your region.

2. For details on extended cooling operation range down to

-10° F DB, see Low Ambient Kit Submittal.

3. When applying product below -4°F, consult your design engineer for cold climate application best practices, including the use of a backup source for heating.

4. Unit will continue to operate in extended operating range, but capacity is not guaranteed.

5. Efficiency ratings are based on AHRI 1230 test method



SPECIFICATIONS: ▼
Y-SERIES (STANDARD-EFFICIENCY)

TUHYP* (3/4)BN40A**

SPECIFICATIONS			MODEL NAMES		
VOLTAGES	208V / 230V		TUHYP3123BN40A(N/B) With 2 TUHYP1203AN40A(N/B) and 1 TUHYP0723AN40A(N/B)	TUHYP3363BN40A(N/B) With 2 TUHYP1203AN40A(N/B) and 1 TUHYP0963AN40A(N/B)	TUHYP3603BN40A(N/B) With 3 TUHYP1203AN40A(N/B)
	460V		TUHYP3124BN40A(N/B) With 2 TUHYP1204AN40A(N/B) and 1 TUHYP0724AN40A(N/B)	TUHYP3364BN40A(N/B) With 2 TUHYP0724AN40A(N/B) and 1 TUHYP0964AN40A(N/B)	TUHYP3604BN40A(N/B) With 3 TUHYP1204AN40A(N/B)
Power Source			3-phase 3-wire 208-230 V ±10% 60 Hz		
			3-phase 3-wire 460 V ±10% 60 Hz		
Capacity (Nominal)	Cooling	BTUH	312,000	336,000	360,000
	Heating	BTUH	350,000	378,000	405,000
Electrical Supply	MCA	A	Refer to: TUHYP1203AN40A(N/B) TUHYP0723AN40A(N/B)	Refer to: TUHYP1203AN40A(N/B) TUHYP0963AN40A(N/B)	Refer to: TUHYP1203AN40A(N/B)
	MOP	A			
	SCCR	A	TUHYP1204AN40A(N/B) TUHYP0724AN40A(N/B)	TUHYP0724AN40A(N/B) TUHYP0964AN40A(N/B)	TUHYP1204AN40A(N/B)
	Recommended Fuse Size	A			
Fan	Type X Quantity				
	Airflow Rate	CFM			
	External Static Pressure				
Compressor	Type X Quantity				
	Operating Range		5% to 100%	5% to 100%	5% to 100%
	Lubricant				
Refrigerant	Type		Refer to: TUHYP1203AN40A(N/B) TUHYP0723AN40A(N/B)	Refer to: TUHYP1203AN40A(N/B) TUHYP0963AN40A(N/B)	Refer to: TUHYP1203AN40A(N/B)
External Finish					
Dimensions	Height	In.	TUHYP1204AN40A(N/B) TUHYP0724AN40A(N/B)	TUHYP0724AN40A(N/B) TUHYP0964AN40A(N/B)	TUHYP1204AN40A(N/B)
	Width				
	Depth				
Net Weight		lbs.			
Sound Pressure Level (Measured in Anechoic Room)		dB(A)	64.0/66.0	64.0/66.0	65.0/67.0
Sound Power Level (Measured in Anechoic Room)		dB(A)	84.0/85.0	84.0/85.0	85.0/86.0
Protection Devices	High Pressure		High pressure sensor, High pressure switch at 4.15 MPa (601 psi)		
	Inverter Circuit (Compressor/Fan)		Over-current protection		
Refrigerant Pipe Dimensions	Liquid (High Pressure) (Brazed)	In.	3/4 Brazed		
	Gas (Low Pressure) (Brazed)		1-3/8 Brazed	1-5/8 Brazed	1-5/8 Brazed
Indoor Unit Connectable	Total capacity		50-130% of outdoor unit capacity		
	Model / Quantity		P05-P96/2-50		
Guaranteed Operating Range *1	Cooling (Outdoor) *2		23-126°F (-5-52°C)		
	Heating (Outdoor) *3		-4-60°F (-20-15.5°C)		
Extended Operating Range *4	Heating (Outdoor)		-18-60°F (-28-15.5°C)		
Efficiency Ratings *5	EER (Ducted/Non-Ducted)		11.6 / 11.7	11.7 / 11.8	11.3 / 11.5
	IEER (Ducted/ Non-Ducted)		22.7 / 26.7	23.2 / 26.6	22.4 / 25.7
	COP (Ducted/ Non-Ducted)		3.50 / 3.63	3.50 / 3.57	3.42 / 3.51

NOTES:

Nominal cooling conditions (Test conditions are based on AHRI 1230) Indoor: 80°F D.B./67°F W.B. (26.7°C D.B./19.4°C W.B.), Outdoor: 95°F D.B. (35°C D.B.)

Nominal heating conditions (Test conditions are based on AHRI 1230) Indoor: 70°F D.B. (21.1°C D.B.), Outdoor: 47°F D.B./43°F W.B. (8.3°C D.B./6.1°C W.B.)

Twinning kit is required for combining multiple individual outdoor units in the field for TUHYP*3(4)BN combined systems.

1. Harsh weather environments may demand performance enhancing equipment. Ask your Trane representative for more details about your region.

2. For details on extended cooling operation range down to -10° F DB, see Low Ambient Kit Submittal.

3. When applying product below -4°F, consult your design engineer for cold climate application best practices, including the use of a backup source for heating.

4. Unit will continue to operate in extended operating range, but capacity is not guaranteed.

5. Efficiency ratings are based on AHRI 1230 test method



TUHYP*** (3/4)BN40AN

SPECIFICATIONS			MODEL NAMES		
VOLTAGES		208V /230V	TUHYP3843BN40A(N/B) With 1 TUHYP1443AN40A(N/B)	TUHYP4083BN40A(N/B) With 2 TUHYP1443AN40A(N/B) and 1 TUHYP1203AN40A(N/B)	TUHYP4323BN40A(N/B) With 3 TUHYP1443AN40A(N/B)
		460V	TUHYP3844BN40A(N/B) With 1 TUHYP1444AN40A(N/B) and 2 TUHYP1204AN40A(N/B)	TUHYP4084BN40A(N/B) With 2 TUHYP1444AN40A(N/B) and 1 TUHYP1204AN40A(N/B)	TUHYP4324BN40A(N/B) With 3 TUHYP1444AN40A(N/B)
Power Source			3-phase 3-wire 208-230 V ±10% 60 Hz		
			3-phase 3-wire 460 V ±10% 60 Hz		
Capacity (Nominal)	Cooling	BTUH	384,000	408,000	432,000
	Heating	BTUH	430,000	455,000	480,000
Electrical Supply	MCA	A	Refer to: TUHYP1443AN40A(N/B) TUHYP1203AN40A(N/B)	Refer to: TUHYP1443AN40A(N/B) TUHYP1203AN40A(N/B)	Refer to: With 3 TUHYP1443AN40A(N/B)
	MOP	A			
	SCCR	A	TUHYP1444AN40A(N/B) TUHYP1204AN40A(N/B)	TUHYP1444AN40A(N/B) TUHYP1204AN40A(N/B)	With 3 TUHYP1444AN40A(N/B)
	Recommended Fuse Size	A			
Fan	Type X Quantity				
	Airflow Rate	CFM			
	External Static Pressure				
Compressor	Type X Quantity		5% to 100%	5% to 100%	5% to 100%
	Operating Range				
	Lubricant				
Refrigerant	Type		Refer to: TUHYP144TNUA(-BS) TUHYP120TNUA(-BS)	Refer to: TUHYP144TNUA(-BS) TUHYP120TNUA(-BS)	Refer to: TUHYP144TNUA(-BS)
External Finish					
Dimensions	Height	In.	TUHYP1444AN40A(N/B) TUHYP1204AN40A(N/B)	TUHYP1444AN40A(N/B) TUHYP1204AN40A(N/B)	With 3 TUHYP1444AN40A(N/B)
	Width				
	Depth				
Net Weight		lbs.			
Sound Pressure Level (Measured in Anechoic Room)		dB(A)	66.0/68.5	67.0/69.0	67.5/70.0
Sound Power Level (Measured in Anechoic Room)		dB(A)	86.5/87.5	87.0/88.0	88.0/89.0
Protection Devices	High Pressure		High pressure sensor, High pressure switch at 4.15 MPa (601 psi)		
	Inverter Circuit (Compressor/Fan)		Over-current protection		
Refrigerant Pipe Dimensions	Liquid (High Pressure) (Brazed)	In.	3/4 Brazed		
	Gas (Low Pressure) (Brazed)		1-5/8 Brazed		
Indoor Unit Connectable	Total capacity		50-130% of outdoor unit capacity		
	Model / Quantity		P05-P96/2-50	P05-P96/3-50	P05-P96/3-50
Guaranteed Operating Range *1	Cooling (Outdoor) *2		23-126°F (-5-52°C)		
	Heating (Outdoor) *3		-4-60°F (-20-15.5°C)		
Extended Operating Range *4	Heating (Outdoor)		-18-60°F (-28-15.5°C)		
Efficiency Ratings *5	EER (Ducted/Non-Ducted)		11.3 / 11.2	11.3 / 10.9	11.3 / 10.7
	IEER (Ducted/Non-Ducted)		22.3 / 25.8	22.2 / 25.8	22.1 / 25.9
	COP (Ducted/Non-Ducted)		3.39 / 3.45	3.35 / 3.38	3.31 / 3.32

NOTES:

Nominal cooling conditions (Test conditions are based on AHRI 1230) Indoor: 80°FDB./67°FWB. (26.7°CDB./19.4°CWB.), Outdoor: 95°FDB. (35°CDB.)

Nominal heating conditions (Test conditions are based on AHRI 1230) Indoor: 70°FDB. (21.1°CDB.), Outdoor: 47°FDB./43°FWB. (8.3°CDB./6.1°CWB.)

Twinning kit is required for combining multiple individual outdoor units in the field for TUHYP*3(4)BN combined systems.

1. Harsh weather environments may demand performance enhancing equipment. Ask your

Trane representative for more details about your region.

2. For details on extended cooling operation range down to -10° F DB, see Low Ambient Kit Submittal.

3. When applying product below -4°F, consult your design engineer for cold climate application best practices, including the use of a backup source for heating.

4. Unit will continue to operate in extended operating range, but capacity is not guaranteed.

5. Efficiency ratings are based on AHRI 1230 test method



TUHYE*** (3/4)AN40A

SPECIFICATIONS			MODEL NAMES		
VOLTAGES	208V /230V		TUHYE0723AN40A(N/B)	TUHYE0963AN40A(N/B)	TUHYE1203AN40A(N/B)
	460V		TUHYE0724AN40A(N/B)	TUHYE0964AN40A(N/B)	TUHYE1204AN40A(N/B)
Power Source			3-phase 3-wire 208-230 V ±10% 60 Hz		
			3-phase 3-wire 460 V ±10% 60 Hz		
Capacity (Nominal)	Cooling	BTUH	72,000	96,000	120,000
	Heating	BTUH	80,000	108,000	135,000
Electrical Supply	MCA	A	23/21	31/29	40/37
			10	14	18
	MOP	A	35/30	45/40	60/50
			15	20	25
	SCCR	A	5	5	5
Recommended Fuse Size	A	35/30 15	45/40 20	60/50 25	
Fan	Type X Quantity		Propeller fan x 1	Propeller fan x 2	Propeller fan x 2
	Airflow Rate	CFM	6,000	6,700	7,750
	External Static Pressure		Selectable; 0, 0.12, 0.24, 0.32 in.WG; factory set to 0 in.WG		
Compressor	Type X Quantity		Inverter scroll hermetic compressor x 1		
	Operating Range		15% to 100%	15% to 100%	15% to 100%
	Lubricant		MEL32		
Refrigerant	Type		R410A		
External Finish			Pre-coated galvanized steel sheet (+powder coating for -BS type) <MUNSELL 3Y 7.8/1.1 or similar>		
Dimensions	Height	In.	71-5/8		
	Width		36-1/4	48-7/8	48-7/8
	Depth		29-3/16		
Net Weight		lbs.	512	622	633
			545	657	668
Sound Pressure Level (Measured in Anechoic Room)		dB(A)	55.0/57.0	56.0/58.5	59.5/61.5
Sound Power Level (Measured in Anechoic Room)		dB(A)	74.0/76.0	75.0/77.5	79.5/80.5
Protection Devices	High Pressure		High pressure sensor, High pressure switch at 4.15 MPa (601 psi)		
	Inverter Circuit (Compressor/Fan)		Over-current protection		
Refrigerant Pipe Dimensions	Liquid (High Pressure) (Brazed)	In.	3/8 Brazed	3/8 Brazed (1/2 Brazed, the farthest pipe length >= 90 m)	3/8 Brazed (1/2 Brazed, the farthest pipe length >= 40 m)
	Gas (Low Pressure) (Brazed)		7/8 Brazed	7/8 Brazed	1-1/8 Brazed
Indoor Unit Connectable	Total capacity		50-130% of outdoor unit capacity		
	Model / Quantity		P05-P72/1-15	P05-P96/1-20	P05-P96/1-26
Guaranteed Operating Range *1	Cooling (Outdoor) *2		23-126°F (-5-52°C)		
	Heating (Outdoor) *3		-13F-60°F (-25-15.5°C)		
Extended Operating Range *4	Heating (Outdoor)		-25-60°F (-31.5-15.5°C)		
Efficiency Ratings *5	EER (Ducted/Non-Ducted)		13.5 / 15.5	14.1 / 15.3	13.3 / 14.3
	IEER (Ducted/Non-Ducted)		25.3 / 32.5	26.7 / 34.0	25.4 / 30.8
	COP (Ducted/Non-Ducted)		4.05 / 4.57	4.04 / 4.39	3.80 / 4.21

NOTES:

Nominal cooling conditions (Test conditions are based on AHRI 1230) Indoor: 80°FDB./67°FWB. (26.7°CDB./19.4°CWB.), Outdoor: 95°FDB. (35°CDB.)

Nominal heating conditions (Test conditions are based on AHRI 1230) Indoor: 70°FDB. (21.1°CDB.), Outdoor: 47°FDB./43°FWB. (8.3°CDB./6.1°CWB.)

1. Harsh weather environments may demand performance enhancing equipment. Ask your Trane representative for more details about your region.

2. For details on extended cooling operation range down to -10°F DB, see Low Ambient Kit Submittal.

3. When applying product below -4°F, consult your design engineer for cold climate application best practices, including the use of a backup source for heating.

4. Unit will continue to operate in extended operating range, but capacity is not guaranteed.

5. Efficiency ratings are based on AHRI 1230 test method



TUHYE* (3/4)AN40A**

SPECIFICATIONS			MODEL NAMES		
VOLTAGES	208V /230V		TUHYE1443AN40A(N/B)	TUHYE1683AN40A(N/B)	TUHYE1923AN40A(N/B)
	460V		TUHYE1444AN40A(N/B)	TUHYE1684AN40A(N/B)	TUHYE1924AN40A(N/B)
Power Source			3-phase 3-wire 208-230 V ±10% 60 Hz		
			3-phase 3-wire 460 V ±10% 60 Hz		
Capacity (Nominal)	Cooling	BTUH	144,000	168,000	192,000
	Heating	BTUH	160,000	188,000	215,000
Electrical Supply	MCA	A	47/44	56/51	68/62
			21	25	31
	MOP	A	70/70	90/80	110/100
			35	40	40
	SCCR	A	5	5	5
Recommended Fuse Size	A	60/60	70/70	70/70	
			30	35	40
Fan	Type X Quantity		Propeller fan x 2		
	Airflow Rate	CFM	9,200	10,600	12,700
	External Static Pressure		Selectable; 0, 0.12, 0.24, 0.32 in.WG; factory set to 0 in.WG		
Compressor	Type X Quantity		Inverter scroll hermetic compressor x 1		
	Operating Range		15% to 100%	15% to 100%	15% to 100%
	Lubricant		MEL32		
Refrigerant	Type		R410A		
External Finish			Pre-coated galvanized steel sheet (+powder coating for -BS type) <MUNSELL 3Y 7.8/1.1 or similar>		
Dimensions	Height	In.	71-5/8		
	Width		48-7/8	68-15/16	68-15/16
	Depth		29-3/16		
Net Weight		lbs.	680	757	757
			715	788	788
Sound Pressure Level (Measured in Anechoic Room)		dB(A)	62.0/64.5	60.0/61.5	61.5/63.5
Sound Power Level (Measured in Anechoic Room)		dB(A)	82.5/83.5	78.5/80.5	80.0/82.5
Protection Devices	High Pressure		High pressure sensor, High pressure switch at 4.15 MPa (601 psi)		
	Inverter Circuit (Compressor/Fan)		Over-current protection		
Refrigerant Pipe Dimensions	Liquid (High Pressure) (Brazed)	In.	1/2 Brazed	5/8 Brazed	5/8 Brazed
	Gas (Low Pressure) (Brazed)		1-1/8 Brazed	1-1/8 Brazed	1-1/8 Brazed
Indoor Unit Connectable	Total capacity		50-130% of outdoor unit capacity		
	Model / Quantity		P05-P96/1-31	P05-P96/1-36	P05-P96/1-41
Guaranteed Operating Range *1	Cooling (Outdoor) *2		23-126°F (-5-52°C)		
	Heating (Outdoor) *3		-13F-60°F (-25-15.5°C)		
Extended Operating Range *4	Heating (Outdoor)		-25-60°F (-31.5-15.5°C)		
Efficiency Ratings *5	EER (Ducted/Non-Ducted)		12.4 / 13.4	11.7 / 12.4	10.7 / 11.7
	IEER (Ducted/Non-Ducted)		24.6 / 30.4	24.0 / 31.2	23.1 / 30.0
	COP (Ducted/Non-Ducted)		3.68 / 4.01	3.61 / 4.11	3.51 / 4.04

NOTES:

Nominal cooling conditions (Test conditions are based on AHRI 1230) Indoor: 80°FDB./67°FWB. (26.7°CDB./19.4°CWB.), Outdoor: 95°FDB. (35°CDB.)

Nominal heating conditions (Test conditions are based on AHRI 1230) Indoor: 70°FDB. (21.1°CDB.), Outdoor: 47°FDB./43°FWB. (8.3°CDB./6.1°CWB.)

1. Harsh weather environments may demand performance enhancing equipment. Ask your Trane representative for more details about your region.

2. For details on extended cooling operation range down to -10° F DB, see Low Ambient Kit Submittal.

3. When applying product below -4°F, consult your design engineer for cold climate application best practices, including the use of a backup source for heating.

4. Unit will continue to operate in extended operating range, but capacity is not guaranteed.

5. Efficiency ratings are based on AHRI 1230 test method



SPECIFICATIONS: ▼
Y-SERIES (HIGH-EFFICIENCY)

TUHYE*** $\frac{3}{4}$ BN40A

SPECIFICATIONS			MODEL NAMES			
VOLTAGES	208V /230V		TUHYE1923BN40A(N/B)	TUHYE2163BN40A(N/B)	TUHYE2403BN40A(N/B)	TUHYE2643BN40A(N/B)
		With 2 TUHYE0963AN40A(N/B)	With 1 TUHYE1203AN40A(N/B) and 1 TUHYE0963AN40A(N/B)	With 2 TUHYE1203AN40A(N/B)	With 2 TUHYE0963AN40A(N/B) and 1 TUHYE0723AN40A(N/B)	
	460V		TUHYE1924BN40A(N/B)	TUHYE2164BN40A(N/B)	TUHYE2404BN40A(N/B)	TUHYE2644BN40A(N/B)
		With 2 TUHYE0964AN40A(N/B)	With 1 TUHYE1204AN40A(N/B) and 1 TUHYE0964AN40A(N/B)	With 2 TUHYE1204AN40A(N/B)	With 2 TUHYE0964AN40A(N/B) and 1 TUHYE0724AN40A(N/B)	
Power Source			3-phase 3-wire 208-230 V \pm 10% 60 Hz			
			3-phase 3-wire 460 V \pm 10% 60 Hz			
Capacity (Nominal)	Cooling	BTUH	192,000	216,000	240,000	264,000
	Heating	BTUH	216,000	243,000	270,000	296,000
Electrical Supply	MCA	A	Refer to: TUHYE0963AN40A(N/B)	Refer to: TUHYE1203AN40A(N/B) TUHYE0963AN40A(N/B)	Refer to: TUHYE1203AN40A(N/B)	Refer to: TUHYE0963AN40A(N/B) TUHYE0723AN40A(N/B)
	MOP	A				
	SCCR	A				
	Recommended Fuse Size	A	With 2 TUHYE0964AN40A(N/B)	TUHYE1204AN40A(N/B) TUHYE0964AN40A(N/B)	TUHYE1204AN40A(N/B)	TUHYE0964AN40A(N/B) TUHYE0724AN40A(N/B)
Fan	Type X Quantity					
	Airflow Rate	CFM				
	External Static Pressure					
Compressor	Type X Quantity					
	Operating Range		7.5% to 100%	7.5% to 100%	7.5% to 100%	5% to 100%
Refrigerant	Lubricant		Refer to: TUHYE0963AN40A(N/B)	Refer to: TUHYE1203AN40A(N/B) TUHYE0963AN40A(N/B)	Refer to: TUHYE1203AN40A(N/B)	Refer to: TUHYE0963AN40A(N/B) TUHYE0723AN40A(N/B)
	Type					
External Finish						
Dimensions	Height	In.	With 2 TUHYE0964AN40A(N/B)	TUHYE1204AN40A(N/B) TUHYE0964AN40A(N/B)	TUHYE1204AN40A(N/B)	TUHYE0964AN40A(N/B) TUHYE0724AN40A(N/B)
	Width					
	Depth					
Net Weight		lbs.				
Sound Pressure Level (Measured in Anechoic Room)		dB(A)	59.5/62.0	61.5/63.5	63.0/65.0	60.5/63.0
Sound Power Level (Measured in Anechoic Room)		dB(A)	78.5/81.0	81.0/82.5	83.0/84.0	79.5/82.0
Protection Devices	High Pressure	High pressure sensor, High pressure switch at 4.15 MPa (601 psi)				
	Inverter Circuit (Compressor/Fan)	Over-current protection				
Refrigerant Pipe Dimensions	Liquid (High Pressure) (Braze)	In.	5/8 Braze	5/8 Braze	5/8 Braze	3/4 Braze
	Gas (Low Pressure) (Braze)		1-1/8 Braze	1-1/8 Braze	1-1/8 Braze	1-3/8 Braze
Indoor Unit Connectable	Total capacity	50-130% of outdoor unit capacity				
	Model / Quantity		P05-P96/1-41	P05-P96/2-46	P05-P96/2-50	P05-P96/2-50
Guaranteed Operating Range *1	Cooling (Outdoor) *2	23-126°F (-5-52°C)				
	Heating (Outdoor) *3	-13F-60°F (-25-15.5°C)				
Extended Operating Range *4	Heating (Outdoor)	-25-60°F (-31.5-15.5°C)				
Efficiency Ratings *5	EER (Ducted/Non-Ducted)		13.0 / 14.3	12.7 / 13.8	12.3 / 12.5	12.7 / 13.4
	IEER (Ducted/Non-Ducted)		25.3 / 32.6	24.8 / 31.1	24.2 / 27.7	24.6 / 30.0
	COP (Ducted/Non-Ducted)		3.75 / 4.11	3.65 / 4.03	3.54 / 3.73	3.72 / 3.94

NOTES:

Nominal cooling conditions (Test conditions are based on AHRI 1230) Indoor: 80°F D.B./67°F W.B. (26.7°C D.B./19.4°C W.B.), Outdoor: 95°F D.B. (35°C D.B.)

Nominal heating conditions (Test conditions are based on AHRI 1230) Indoor: 70°F D.B. (21.1°C D.B.), Outdoor: 47°F D.B./43°F W.B. (8.3°C D.B./6.1°C W.B.)

Twinning kit is required for combining multiple individual outdoor units in the field for TUHYE*3(4)BN combined systems.

1. Harsh weather environments may demand performance enhancing equipment. Ask your Trane representative for more details about your region.

2. For details on extended cooling operation range down to -10° F DB, see Low Ambient Kit Submittal.

3. When applying product below -4°F, consult your design engineer for cold climate application best practices, including the use of a backup source for heating.

4. Unit will continue to operate in extended operating range, but capacity is not guaranteed.

5. Efficiency ratings are based on AHRI 1230 test method



TUHYE** (3/4)BN40A

SPECIFICATIONS			MODEL NAMES				
VOLTAGES	208V /230V		TUHYE2883BN40A(N/B)	TUHYE3123BN40A(N/B)	TUHYE3363BN40A(N/B)	TUHYE3603BN40A(N/B)	
		With TUHYE1203AN40A(N/B) and TUHYE0963AN40A(N/B) and TUHYE0723AN40A(N/B)	With 2 TUHYE1203AN40A(N/B) and 1 TUHYE0723AN40A(N/B)	With 2 TUHYE1203AN40A(N/B) and 1 TUHYE0963AN40A(N/B)	With 3 TUHYE1203AN40A(N/B)		
	460V		TUHYE2884BN40A(N/B)	TUHYE3124BN40A(N/B)	TUHYE3364BN40A(N/B)	TUHYE3604BN40A(N/B)	
		With TUHYE1204AN40A(N/B) and TUHYE0964AN40A(N/B) and TUHYE0724AN40A(N/B)	With 2 TUHYE1204AN40A(N/B) and 1 TUHYE0724AN40A(N/B)	With 2 TUHYE1204AN40A(N/B) and 1 TUHYE0964AN40A(N/B)	With 3 TUHYE1204AN40A(N/B)		
Power Source			3-phase 3-wire 208-230 V ±10% 60 Hz				
			3-phase 3-wire 460 V ±10% 60 Hz				
Capacity (Nominal)	Cooling	BTUH	288,000	312,000	336,000	360,000	
	Heating	BTUH	323,000	350,000	378,000	405,000	
Electrical Supply	MCA	A	Refer to: TUHYE1203AN40A(N/B) TUHYE0963AN40A(N/B) TUHYE0723AN40A(N/B)	Refer to: TUHYE1203AN40A(N/B) TUHYE0723AN40A(N/B)	Refer to: TUHYE1203AN40A(N/B) TUHYE0963AN40A(N/B)	Refer to: TUHYE1203AN40A(N/B)	
	MOP	A					
	SCCR	A					
	Recommended Fuse Size	A	TUHYE1204AN40A(N/B) TUHYE0964AN40A(N/B) TUHYE0724AN40A(N/B)	TUHYE1204AN40A(N/B) TUHYE0724AN40A(N/B)	TUHYE1204AN40A(N/B) TUHYE0964AN40A(N/B)	TUHYE1204AN40A(N/B)	
Fan	Type X Quantity						
	Airflow Rate	CFM					
	External Static Pressure						
Compressor	Type X Quantity						
	Operating Range		5% to 100%	5% to 100%	5% to 100%	5% to 100%	
Lubricant							
Refrigerant	Type	Refer to: TUHYE1203AN40A(N/B) TUHYE0963AN40A(N/B) TUHYE0723AN40A(N/B)	Refer to: TUHYE1203AN40A(N/B) TUHYE0723AN40A(N/B)	Refer to: TUHYE1203AN40A(N/B) TUHYE0963AN40A(N/B)	Refer to: TUHYE1203AN40A(N/B)		
External Finish							
Dimensions	Height	In.					
	Width						
	Depth						
Net Weight		lbs.	TUHYE1204AN40A(N/B) TUHYE0964AN40A(N/B) TUHYE0724AN40A(N/B)	TUHYE1204AN40A(N/B) TUHYE0724AN40A(N/B)	TUHYE1204AN40A(N/B) TUHYE0964AN40A(N/B)	TUHYE1204AN40A(N/B)	
Sound Pressure Level (Measured in Anechoic Room)							
Sound Power Level (Measured in Anechoic Room)			dB(A)	82.0/83.5	83.5/84.5	83.5/84.5	84.5/85.5
Protection Devices	High Pressure		High pressure sensor, High pressure switch at 4.15 MPa (601 psi)				
	Inverter Circuit (Compressor/Fan)		Over-current protection				
Refrigerant Pipe Dimensions	Liquid (High Pressure) (Braze)	In.	3/4 Braze				
	Gas (Low Pressure) (Braze)		1-3/8 Braze	1-3/8 Braze	1-5/8 Braze	1-5/8 Braze	
Indoor Unit Connectable	Total capacity		50-130% of outdoor unit capacity				
	Model / Quantity		P05-P96/2-50				
Guaranteed Operating Range *1	Cooling (Outdoor) *2		23-126°F (-5-52°C)				
	Heating (Outdoor) *3		-13F-60°F (-25-15.5°C)				
Extended Operating Range *4	Heating (Outdoor)		-25-60°F (-31.5-15.5°C)				
Efficiency Ratings *5	EER (Ducted/Non-Ducted)		12.4 / 13.2	12.2 / 12.6	12.4 / 12.3	12.2 / 12.1	
	IEER (Ducted/Non-Ducted)		24.2 / 29.3	23.9 / 27.7	24.3 / 27.6	24.0 / 26.9	
	COP (Ducted/Non-Ducted)		3.65 / 3.91	3.58 / 3.78	3.58 / 3.68	3.51 / 3.65	

NOTES:

Nominal cooling conditions (Test conditions are based on AHRI 1230) Indoor: 80°F D.B./67°F W.B. (26.7°C D.B./19.4°C W.B.), Outdoor: 95°F D.B. (35°C D.B.)

Nominal heating conditions (Test conditions are based on AHRI 1230) Indoor: 70°F D.B. (21.1°C D.B.), Outdoor: 47°F D.B./43°F W.B. (8.3°C D.B./6.1°C W.B.)

Twinning kit is required for combining multiple individual outdoor units in the field for TUHYE*3(4)BN combined systems.

1. Harsh weather environments may demand performance enhancing equipment. Ask your Trane representative for more details about your region.

2. For details on extended cooling operation range down to -10° F DB, see Low Ambient Kit Submittal.

3. When applying product below -4°F, consult your design engineer for cold climate application best practices, including the use of a backup source for heating.

4. Unit will continue to operate in extended operating range, but capacity is not guaranteed.

5. Efficiency ratings are based on AHRI 1230 test method



SPECIFICATIONS: ▼
Y-SERIES (HIGH-EFFICIENCY)

TUHYE* (3/4)BN40A**

SPECIFICATIONS			MODEL NAMES		
VOLTAGES	208V /230V		TUHYE3843BN40A(N/B)	TUHYE4083BN40A(N/B)	TUHYE4323BN40A(N/B)
			With 1 TUHYE1443AN40A(N/B) and 2 TUHYE1203AN40A(N/B)	With 2 TUHYE1443AN40A(N/B) and 1 TUHYE1203AN40A(N/B)	With 3 TUHYE1443AN40(N/B)
	460V		TUHYE3844BN40A(N/B)	TUHYE4084BN40A(N/B)	TUHYE4324BN40A(N/B)
			With 1 TUHYE1444AN40A(N/B) and 2 TUHYE1204AN40A(N/B)	With 2 TUHYE1444AN40A(N/B) and 1 TUHYE1204AN40A(N/B)	With 3 TUHYE1444AN40A(N/B)
Power Source			3-phase 3-wire 208-230 V ±10% 60 Hz		
			3-phase 3-wire 460 V ±10% 60 Hz		
Capacity (Nominal)	Cooling	BTUH	384,000	408,000	432,000
	Heating	BTUH	430,000	455,000	480,000
Electrical Supply	MCA	A	Refer to: TUHYE1443AN40A(N/B) TUHYE1203AN40A(N/B)	Refer to: TUHYE1443AN40A(N/B) TUHYE1203AN40A(N/B)	Refer to: TUHYE1443AN40(N/B)
	MOP	A			
	SCCR	A	TUHYE1444AN40A(N/B) TUHYE1204AN40A(N/B)	TUHYE1444AN40A(N/B) TUHYE1204AN40A(N/B)	TUHYE1444AN40A(N/B)
	Recommended Fuse Size	A			
Fan	Type X Quantity				
	Airflow Rate	CFM			
	External Static Pressure				
Compressor	Type X Quantity				
	Operating Range		5% to 100%	5% to 100%	5% to 100%
Refrigerant	Type		Refer to: TUHYE1443AN40A(N/B) TUHYE1203AN40A(N/B)	Refer to: TUHYE1443AN40A(N/B) TUHYE1203AN40A(N/B)	Refer to: TUHYE1443AN40(N/B)
External Finish					
Dimensions	Height	In.	TUHYE1444AN40A(N/B) TUHYE1204AN40A(N/B)	TUHYE1444AN40A(N/B) TUHYE1204AN40A(N/B)	TUHYE1444AN40A(N/B)
	Width				
	Depth				
Net Weight		lbs.			
Sound Pressure Level (Measured in Anechoic Room)		dB(A)	65.5/68.0	66.5/68.5	67.0/69.5
Sound Power Level (Measured in Anechoic Room)		dB(A)	86.0/87.0	86.5/87.5	87.5/88.5
Protection Devices	High Pressure		High pressure sensor, High pressure switch at 4.15 MPa (601 psi)		
	Inverter Circuit (Compressor/Fan)		Over-current protection		
Refrigerant Pipe Dimensions	Liquid (High Pressure) (Brazed)	In.	3/4 Brazed		
	Gas (Low Pressure) (Brazed)		1-5/8 Brazed		
Indoor Unit Connectable	Total capacity		50-130% of outdoor unit capacity		
	Model / Quantity		P05-P96/2-50	P05-P96/3-50	P05-P96/3-50
Guaranteed Operating Range *1	Cooling (Outdoor) *2		23-126°F (-5-52°C)		
	Heating (Outdoor) *3		-13F-60°F (-25-15.5°C)		
Extended Operating Range *4	Heating (Outdoor)		-25-60°F (-31.5-15.5°C)		
Efficiency Ratings *5	EER (Ducted/Non-Ducted)		11.9 / 11.8	11.7 / 11.4	11.4 / 11.1
	IEER (Ducted/Non-Ducted)		23.8 / 26.6	23.5 / 26.3	23.3 / 25.9
	COP (Ducted/Non-Ducted)		3.48 / 3.57	3.45 / 3.49	3.41 / 3.41

NOTES:

Nominal cooling conditions (Test conditions are based on AHRI 1230) Indoor: 80°FDB./67°FWB. (26.7°CDB./19.4°CWB.), Outdoor: 95°FDB. (35°CDB.)

Nominal heating conditions (Test conditions are based on AHRI 1230) Indoor: 70°FDB. (21.1°CDB.), Outdoor: 47°FDB./43°FWB. (8.3°CDB./6.1°CWB.)

Twinning kit is required for combining multiple individual outdoor units in the field for TUHYE*** (3/4)BN combined systems.

1. Harsh weather environments may demand performance enhancing equipment. Ask your Trane representative for more details about your region.

2. For details on extended cooling operation range down to -10° F DB, see Low Ambient Kit Submittal.

3. When applying product below -4°F, consult your design engineer for cold climate application best practices, including the use of a backup source for heating.

4. Unit will continue to operate in extended operating range, but capacity is not guaranteed.

5. Efficiency ratings are based on AHRI 1230 test method



TUHYH* (3/4)AN40AN**

SPECIFICATION			MODEL NAMES		
VOLTAGES	208V /230V		TUHYH0723AN40AN	TUHYH0963AN40AN	TUHYH1203AN40AN
	460V		TUHYH0724AN40AN	TUHYH0964AN40AN	TUHYH1204AN40AN
Power Source			3-phase 3-wire 208-230 V ±10% 60 Hz		
			3-phase 3-wire 460 V ±10% 60 Hz		
Capacity (Nominal)	Cooling	BTUH	72,000	96,000	120,000
	Heating	BTUH	80,000	108,000	135,000
Electrical Supply	MCA	A	38/35	43/40	47/43
			17	20	21
	MOP	A	60/50	70/60	70/60
			25	30	35
	SCCR	A	5	5	5
Recommended Fuse Size	A	60/50	70/60	70/60	
		25	30	35	
Fan	Type X Quantity		Propeller fan x 2		
	Airflow Rate	CFM	6,700	7,400	7,750
	External Static Pressure		Selectable; 0, 0.12, 0.24, 0.32 in.WG; factory set to 0 in.WG		
Compressor	Type X Quantity		Inverter scroll hermetic compressor x 1		
	Operating Range		15% to 100%	15% to 100%	15% to 100%
	Lubricant		MEL46		
Refrigerant	Type		R410A		
External Finish			Pre-coated galvanized steel sheet <MUNSELL 3Y 7.8/1.1 or similar>		
Dimensions	Height	In.	71-5/8		
	Width	In.	48-7/8		
	Depth	In.	29-3/16		
Net Weight	lbs.	609	653	655	
		644	688	691	
Sound Pressure Level (Measured in Anechoic Room)		dB(A)	55.0/57.0	56.0/58.5	59.5/61.5
Sound Power Level (Measured in Anechoic Room)		dB(A)	74.0/76.0	75.0/77.5	79.5/80.5
Protection Devices	High Pressure		Over-current protection		
	Inverter Circuit (Compressor/Fan)		Over-current protection		
Refrigerant Pipe Dimensions	Liquid (High Pressure) (Brazed)	In.	3/8 Brazed	3/8 Brazed (1/2 Brazed, the farthest pipe length >= 90 m)	3/8 Brazed (1/2 Brazed, the farthest pipe length >= 40 m)
	Gas (Low Pressure) (Brazed)	In.	7/8 Brazed	7/8 Brazed	1-1/8 Brazed
Indoor Unit Connectable	Total capacity		50-130% of outdoor unit capacity		
	Model / Quantity		P05-P72/1-15	P05-P96/1-20	P05-P96/1-26
Guaranteed Operating Range *1	Cooling (Outdoor) *2		23-126°F (-5-52°C)		
	Heating (Outdoor) *3		-22-60°F (-30-15.5°C)		
Extended Operating Range *4	Heating (Outdoor)		-31-60°F (-35-15.5°C)		
Efficiency Ratings *5	EER (Ducted/Non-Ducted)		11.9 / 13.1	13.8 / 15.1	12.5 / 14.1
	IEER (Ducted/Non-Ducted)		21.1 / 27.2	19.8 / 26.7	19.7 / 24.5
	COP (Ducted/Non-Ducted)		4.03 / 4.39	4 / 4.35	3.76 / 4.26

NOTES:

Nominal cooling conditions (Test conditions are based on AHRI 1230) Indoor: 80°FDB./67°FWB. (26.7°CDB./19.4°CWB.), Outdoor: 95°FDB. (35°CDB.)

Nominal heating conditions (Test conditions are based on AHRI 1230) Indoor: 70°FDB. (21.1°CDB.), Outdoor: 47°FDB./43°FWB. (8.3°CDB./6.1°CWB.)

1. Harsh weather environments may demand performance enhancing equipment. Ask your Trane representative for more details about your region.

2. For details on extended cooling operation range down to -10° F DB, see Low Ambient Kit Submittal.

3. When applying product below -4°F, consult your design engineer for cold climate application best practices, including the use of a backup source for heating.

4. Unit will continue to operate in extended operating range, but capacity is not guaranteed.

5. Efficiency ratings are based on AHRI 1230 test method



SPECIFICATIONS: ▼
Y-SERIES (HYPER HEATING)

TUHYH*** (3/4)BN40AN

SPECIFICATION			MODEL NAMES		
VOLTAGES	208V /230V		TUHYH1443BN40AN	TUHYH1923BN40AN	TUHYH2403BN40AN
		With 2 TUHYH0723AN40AN	With 2 TUHYH0963AN40AN	With 2 TUHYH1203AN40AN	
	460V		TUHYH1444BN40AN	TUHYH1924BN40AN	TUHYH2404BN40AN
		With 2 TUHYH0724AN40AN	With 2 TUHYH0964AN40AN	With 2 TUHYH1204AN40AN	
Power Source			3-phase 3-wire 208-230 V ±10% 60 Hz		
			3-phase 3-wire 460 V ±10% 60 Hz		
Capacity (Nominal)	Cooling	BTUH	144,000	192,000	240,000
	Heating	BTUH	160,000	215,000	270,000
Electrical Supply	MCA	A	Refer to: TUHYH0723AN40AN	Refer to: TUHYH0963AN40AN	Refer to: TUHYH1203AN40AN
	MOP	A			
	SCCR	A	TUHYH0724AN40AN	TUHYH0964AN40AN	TUHYH1204AN40AN
	Recommended Fuse Size	A			
Fan	Type X Quantity				
	Airflow Rate	CFM			
	External Static Pressure				
Compressor	Type X Quantity				
	Operating Range		7.5% to 100%	7.5% to 100%	7.5% to 100%
	Lubricant		Refer to: TUHYH0723AN40AN	Refer to: TUHYH0963AN40AN	Refer to: TUHYH1203AN40AN
Refrigerant	Type		TUHYH0723AN40AN	TUHYH0963AN40AN	TUHYH1203AN40AN
External Finish					
Dimensions	Height	In.			
	Width	In.	TUHYH0724AN40AN	TUHYH0964AN40AN	TUHYH1204AN40AN
	Depth	In.			
Net Weight		lbs.			
Sound Pressure Level (Measured in Anechoic Room)		dB(A)	58.5/60.5	59.5/62.0	63.0/65.0
Sound Pressure Level (Measured in Anechoic Room)		dB(A)	77.5/79.5	78.5/81.0	83.0/84.0
Protection Devices	High Pressure		Over-current protection		
	Inverter Circuit (Compressor/Fan)		Over-current protection		
Refrigerant Pipe Dimensions	Liquid (High Pressure) (Brazed)	In.	1/2 Brazed	5/8 Brazed	5/8 Brazed
	Gas (Low Pressure) (Brazed)	In.	1-1/8 Brazed	1-1/8 Brazed	1-1/8 Brazed
Indoor Unit Connectable	Total capacity		50-130% of outdoor unit capacity		
	Model / Quantity		P05-P96/1-31		
Guaranteed Operating Range *1	Cooling (Outdoor) *2		23-126°F (-5-52°C)		
	Heating (Outdoor) *3		-22-60°F (-30-15.5°C)		
Extended Operating Range *4	Heating (Outdoor)		-31-60°F (-35-15.5°C)		
Efficiency Ratings *5	EER (Ducted/Non-Ducted)		10.8 / 12.1	12.8 / 14.1	11.5 / 12.4
	IEER (Ducted/Non-Ducted)		19.7 / 25.9	18.8 / 25.6	18.7 / 22
	COP (Ducted/Non-Ducted)		3.69 / 4.1	3.71 / 4.07	3.5 / 3.78

NOTES:
Nominal cooling conditions (Test conditions are based on AHRI 1230) Indoor: 80°FDB./67°FWB. (26.7°CDB./19.4°CWB.), Outdoor: 95°FDB. (35°CDB.)
Nominal heating conditions (Test conditions are based on AHRI 1230) Indoor: 70°FDB. (21.1°CDB.), Outdoor: 47°FDB./43°FWB. (8.3°CDB./6.1°CWB.)
Twinning kit is required for combining multiple individual outdoor units in the field for TUHYH*3(4)BN combined systems.
1. Harsh weather environments may demand performance enhancing equipment. Ask your

Trane representative for more details about your region.

- For details on extended cooling operation range down to -10° F DB, see Low Ambient Kit Submittal.
- When applying product below -4°F, consult your design engineer for cold climate application best practices, including the use of a backup source for heating.
- Unit will continue to operate in extended operating range, but capacity is not guaranteed.
- Efficiency ratings are based on AHRI 1230 test method



TUMYPAK42NA and H2i®**

SPECIFICATION			MODEL NAMES				
			TUMYP0361AK42(NA/BA)	TUMYP0481AK42(NA/BA)	TUMYP0601AK42(NA/BA)	TUMYH0361AK40NA	TUMYH0481AK40NA
Power Source			208/230V, 1-Phase, 60Hz				
Capacity *1	Cooling	BTUH	36,000	48,000	60,000	36,000	48,000
	Heating	BTUH	42,000	54,000	66,000	42,000	54,000
Electrical Supply	MCA	A	29		36	36	
	Maximum Overcurrent Protection (MOP)	A	44		45	44	
Recommended Fuse Size		A	30		40		
Short-circuit Current Rating (SCCR)		kA	5				
Fan	Type x Quantity		Propeller Fan x 2				
	Airflow Rate	CFM	3,885		4,879	3,885	
	Motor Output	kW	2.8	3.3	3.9	2.8	3.4
Compressor	Type		INVERTER-driven Scroll Hermetic				
	Operating Range	Cooling	29% to 100%	23% to 100%	28% to 100%	29% to 100%	23% to 100%
		Heating	24% to 100%	18% to 100%	18% to 100%	17% to 100%	16% to 100%
	Motor Output	kW	0.074 + 0.074 (two fan motors)		0.2 + 0.2 (two fan motors)	0.074 + 0.074 (two fan motors)	
	Lubricant		FV50S (2.3 liters)		FVC68D (2.3 liters)	FV50S (2.3 liters)	
Refrigerant			R410A				
External Finish			Galvanized Sheets (plus Powder Coating for -BS Model) Munsell 3Y 7.8/1.1				
Dimensions	Height	In.	52-11/16				
	Width	In.	41-11/32				
	Depth	In.	13 (+1)				
Net Weight		Pounds	267		295	267	
Sound Pressure Levels (As Measured in an Anechoic Room)		dB(A)	49/53	51/54	58/59	49/53	51/54
Protection Devices	High Pressure Protection		High Pressure Switch				
	Compressor		Discharge thermo protection, Over-current protection				
	Inverter Circuit		Over-heat protection, Over-current protection				
Refrigerant Pipe Dimensions	Liquid (High Pressure) (Flare)	In.	3/8				
	Gas (Low Pressure) (Flare)	In.	5/8		3/4	5/8	
Indoor Unit	Total Capacity		50 – 130% of Outdoor Unit Capacity				
	Quantity		P05-P36 / 1-9	P05-P54 / 1-12	P05-P72 / 1-12	P05-P36 / 1-9	P05-P54 / 1-12
Operating Temperature Range	Cooling		Outdoor: 5° to 115° F D.B. *3 *4				
	Heating		Outdoor: -13° to +59° F W.B.				
Efficiency Ratings *2							
EER (Ducted/Non-Ducted)			12.6 / 15.0	11.3 / 13.1	11.1 / 13.3	12.6 / 15.0	11.3 / 13.1
SEER (Ducted/Non-Ducted)			18.3 / 22.3	16.5 / 22.6	17.8 / 20.0	18.3 / 22.3	16.5 / 22.6
COP (Ducted/Non-Ducted)			3.7 / 4.0	3.3 / 4.0	3.7 / 4.1	3.7 / 4.0	3.3 / 4.0
HSPF (Ducted/Non-Ducted)			11.2 / 12.0	11.0 / 12.0	10.7 / 12.0	11.7 / 12.0	11.0 / 12.0

NOTES:

*1 Rating Conditions:

Cooling | Indoor: 80° F (26.7° C) DB/67° F (19.4° C) WB; Outdoor: 95° F (35° C) DB.

Heating | Indoor: 70° F (21.1° C) DB; Outdoor: 47° F (8.3° C) DB/43° F (6.1° C) WB.

*2 Efficiencies values based in AHRI 210/240 test method.

*3 When using Wind Baffles [WB-PA3], the minimum operating range is 5° F.

Without Wind Baffles, the minimum operating range is 23° F.

*4 When connecting TPKFYP006BM142B/P008HM142A,TPFFYP006/008/012CS140A or

TPFFYP006/008/012RE140A indoor units, the minimum operating range is 50° F.

-BA indicates Seacoast Protection option.

LIMITED WARRANTY | Seven-year warranty on compressor. One-year warranty on parts.

See our website for details on specific additional application installation coverage.

Specifications are subject to change.



SPECIFICATIONS: L-GENERATION WR2-SERIES

TQRYP***(3/4)AL141AN

SPECIFICATIONS			MODEL NAMES				
VOLTAGES			208/230V	TQRYP0723AL41AN	TQRYP0963AL41AN	TQRYP1203AL41AN	TQRYP1443AL41AN
			460V	TQRYP0724AL41AN	TQRYP0964AL41AN	TQRYP1204AL41AN	TQRYP1444AL41AN
Power Source			3-phase 3-wire 208-230 V ±10% 60 Hz				
			3-phase 3-wire 460 V ±10% 60 Hz				
Capacity (Nominal) *1	Cooling	BTUH	72,000	96,000	120,000	144,000	
	Heating	BTUH	69,000	92,000	114,000	137,000	
Electrical Supply	MCA	A	13/12	19/17	29/26	35/32	
			6	9	13	16	
	MOP	A	20/20	30/25	50/45	60/50	
			15	15	20	25	
Compressor	Type x Quantity		INVERTER-driven Scroll Hermetic x 1				
	Operating Range		24% to 100%	18% to 100%	14% to 100%	19% to 100%	
	Lubricant		MEL32				
Circulating Water	Water Flow Rate	GPM	25.4	25.4	25.4	31.7	
	Pressure Drop	Ft. (psi)	8 (3.48)	8 (3.48)	8 (3.48)	15 (6.38)	
	Max Water Pressure	psi (MPa)	290 (2)				
Refrigerant	Type		R410A				
External Finish			Galvanized steel sheets				
Dimensions	Height	In.	43-5/16			57-1/8	
	Width	In.	34-11/16				
	Depth	In.	21-11/16				
Net Weight	Pounds	382				481	
		406				508	
Sound Pressure Level (As Measured in an Anechoic Room)		dB(A)	46	48	54		
Protection Devices	High Pressure Protection		High pressure sensor, High pressure switch				
	Compressor		Over-heat protection, Over-current protection				
	Inverter		Over-heat protection				
Refrigerant Pipe Dimensions	Liquid (High Pressure) (Brazed)	In.	5/8	3/4		7/8	
	Gas (Low Pressure) (Brazed)	In.	3/4	7/8		1-1/8	
Indoor Unit Connectable	Total Capacity		50 to 150% of water-source unit capacity				
	Model/Quantity		P06-P96/1-18	P06-P96/1-24	P06-P96/1-30	P06-P96/1-36	
Operating Temperature Range	Cooling	W.B.	Indoor: 59 to 75° F				
	Heating	D.B.	Indoor: 50 to 113° F				
Inlet Water Temperature Range	Cooling		50 to 113° F				
	Heating		50 to 113° F				
Efficiency Ratings (Ducted/ Non-Ducted) *2	EER		16.7/20.1	15.2/18.7	13.4/15.6	12.1/15.4	
	IEER		24.2/28.1	25.0/30.4	23.2/29.0	19.5/23.1	
	COP		5.51/6.05	5.77/5.93	5.51/5.60	4.90/5.50	

NOTES:

*1 Rating Conditions:
Cooling | Indoor: 81° F (27° C) D.B./66° F (19° C) W.B.; Water Temperature: 86° F (30° C)
Heating | Indoor: 68° F (20° C) D.B.; Water Temperature: 68° F (20° C).

*2 Efficiency values based on AHRI 1230 test method.

Specifications are subject to change without notice.

LIMITED WARRANTY | Seven-year compressor and one year parts. Extended warranty of up to 10 years is available. See our website for details on specific additional application installation coverage.



QRYP*(3/4)AL41AN**

SPECIFICATIONS			MODEL NAMES				
VOLTAGE			208/230V	TQRYP1683AL41AN	TQRYP1923AL41AN	TQRYP2163AL41AN	TQRYP2403AL41AN
			460V	TQRYP1684AL41AN	TQRYP1924AL41AN	TQRYP2164AL41AN	TQRYP2404AL41AN
Power Source			3-phase 3-wire 208-230 V ±10% 60 Hz				
			3-phase 3-wire 460 V ±10% 60 Hz				
Capacity (Nominal) *1	Cooling	BTUH	168,000	192,000	216,000	240,000	
	Heating	BTUH	161,000	183,000	206,000	228,000	
Electrical Supply	MCA	A	44/39	54/49	69/63	79/71	
			20	25	31	36	
	MOP	A	70/70	90/80	110/110	125/125	
			35	40	50	60	
Compressor	Type x Quantity		INVERTER-driven Scroll Hermetic x 1				
	Operating Range		16% to 100%	14% to 100%	13% to 100%	12% to 100%	
	Lubricant		MEL32				
Circulating Water	Water Flow Rate	GPM	31.7	31.7	50.7	50.7	
	Pressure Drop	Ft. (psi)	15 (6.38)	15 (6.38)	15 (6.53)	15 (6.53)	
	Max Water Pressure	psi (MPa)	290 (2)				
Refrigerant	Type		R410A				
External Finish			Galvanized steel sheets				
Dimensions	Height	In.	57-1/8				
	Width	In.	34-11/16				
	Depth	In.	21-11/16				
Net Weight	Pounds	481	558				
		508	574				
Sound Pressure Level (As Measured in an Anechoic Room)		dB(A)	56	58			
Protection Devices	High Pressure Protection		High pressure sensor, High pressure switch				
	Compressor		Over-heat protection, Over-current protection				
	Inverter		Over-heat protection				
Refrigerant Pipe Dimensions	Liquid (High Pressure) (Brazed)	In.	7/8	7/8 (1-1/8 for the part that exceeds 65 m)			
	Gas (Low Pressure) (Brazed)	In.	1-1/8	1-3/8			
Indoor Unit Connectable	Total Capacity		50 to 150% of water-source unit capacity				
	Model/Quantity		P06-P96/1-42	P06-P96/1-48	P06-P96/2-50 (Connectable branch pipe number is max. 48.)	P06-P96/2-50 (Connectable branch pipe number is max. 48.)	
Operating Temperature Range	Cooling	W.B.	Indoor: 59 to 75° F				
	Heating	D.B.	Indoor: 50 to 113° F				
Inlet Water Temperature Range	Cooling		50 to 113° F				
	Heating		50 to 113° F				
Efficiency Ratings (Ducted/ Non-Ducted) *2	EER		11.9/13.5	11.5/12.4	11.2/10.9	10.8/11.0	
	IEER		18.0/21.8	18.4/21.7	19.0/21.2	18.8/21.2	
	COP		5.29/5.94	4.73/5.39	5.57/5.67	4.60/5.15	

NOTES:

*1 Rating Conditions: Cooling | Indoor: 81° F (27° C) D.B./66° F (19° C) W.B.;
 Water Temperature: 86° F (30° C) Heating | Indoor: 68° F (20° C) D.B.;
 Water Temperature: 68° F (20° C).

*2 Efficiency values based on AHRI 1230 test method.

Specifications are subject to change without notice.
 LIMITED WARRANTY | Seven-year compressor and one year parts. Extended warranty of up to 10 years is available. See our website for details on specific additional application installation coverage.



SPECIFICATIONS: L-GENERATION WR2-SERIES

TQRYP***(3/4)BL41AN

SPECIFICATIONS			MODEL NAMES				
VOLTAGES	208 /230V		TQRYP1443BL41AN	TQRYP1683BL41AN	TQRYP1923BL41AN	TQRYP2163BL41AN	TQRYP2403BL41AN
		With 2 TQRYP0723AL41AN	With 1 TQRYP0723AL41AN and 1 TQRYP0963AL41AN	With 2 TQRYP0963AL41AN	With 1 TQRYP0963AL41AN and 1 TQRYP1203AL41AN	With 2 TQRYP1203AL41AN	With 1 TQRYP1203AL41AN and 1 TQRYP2404BL41AN
	460V		TQRYP1444BL41AN	TQRYP1684BL41AN	TQRYP1924BL41AN	TQRYP2164BL41AN	TQRYP2404BL41AN
		With 2 TQRYP0724AL41AN	With 1 TQRYP0724AL41AN and 1 TQRYP0964AL41AN	With 2 TQRYP0964AL41AN	With 1 TQRYP0964AL41AN and 1 TQRYP1204AL41AN	With 2 TQRYP1204AL41AN	With 1 TQRYP1204AL41AN and 1 TQRYP2404BL41AN
Power Source			208/230V, 3-Phase, 60Hz				
			460V, 3-Phase, 60Hz				
Capacity (Nominal) *1	Cooling	BTUH	144,000	168,000	192,000	216,000	240,000
	Heating	BTUH	160,000	188,000	215,000	243,000	270,000
Compressor	Operating Range		12% to 100%	10% to 100%	9% to 100%	8% to 100%	7% to 100%
	Type x Quantity		Refer to:	Refer to:	Refer to:	Refer to:	Refer to:
	Lubricant		TQRYP0723AL41AN	TQRYP0723AL41AN	TQRYP0963AL41AN	TQRYP0963AL41AN	TQRYP1203AL41AN
Circulating Water	Water Flow Rate	GPM (L/s)	TQRYP0724AL41AN	TQRYP0963AL41AN	TQRYP0964AL41AN	TQRYP0964AL41AN	TQRYP1204AL41AN
	Pressure Drop	Ft. (psi)					
	Max Water Pressure	psi (MPa)					
Refrigerant	Type		TQRYP0724AL41AN	TQRYP0724AL41AN	TQRYP0964AL41AN	TQRYP0964AL41AN	TQRYP1204AL41AN
External Finish							
Dimensions	Height	In.					
	Width	In.					
	Depth	In.					
Net Weight	Pounds		49	50	51	55	57
Sound Pressure Level (As Measured in an Anechoic Room)	dB(A)		49	50	51	55	57
	Protection Devices	High Pressure Protection	High pressure sensor, High pressure switch				
		Compressor/Fan	Overheat protection,Thermal switch				
Inverter		Overheat and Overcurrent Protection					
Refrigerant Pipe Dimensions	Liquid (High Pressure) (Brazed)	In.	7/8			7/8 (1-1/8 for the part that exceeds 65 m)	
	Gas (Low Pressure) (Brazed)	In.	1-1/8				1-3/8
Indoor Unit Connectable	Total Capacity		50 to 150% of outdoor unit capacity				
	Model/Quantity		P06-P96/1-36	P06-P96/1-42	P06-P96/1-48	P06-P96/2-50 (Connectable branch pipe number is max. 48.)	P06-P96/2-50 (Connectable branch pipe number is max. 48.)
Inlet Water Temperature Range	Cooling	50 to 113° F					
	Heating	50 to 113° F					
Efficiency Ratings (Ducted/ Non-Ducted) *4	EER	15.1/18.6	14.8/17.1	14.4/16.2	13.5/14.9	12.5/13.8	
	IEER	22.5/26.1	23.6/25.8	24.4/26.4	23.5/25.9	22.4/25.7	
	COP	5.77/5.53	4.75/5.23	5.64/5.40	4.52/5.05	5.46/5.32	

NOTES:

*1 Rating Conditions:
Cooling | Indoor: 81° F (27° C) D.B./66° F (19° C) W.B.; Water Temperature: 86° F (30° C)
Heating | Indoor: 68° F (20° C) D.B.; Water Temperature: 68° F (20° C).

*2 Twinning kit is required for combining two individual outdoor units in the field for TQRYP*3(4)BL.

*3 Each individual outdoor unit requires a separate electrical connection. Reference electrical data for each individual outdoor unit.

*4 Efficiency values based on AHRI 1230 test method.

Specifications are subject to change without notice.

LIMITED WARRANTY | Seven-year compressor and one year parts. Extended warranty of up to 10 years is available. See our website for details on specific additional application installation coverage.



TQRYP (3/4)BL41AN**

SPECIFICATIONS			MODEL NAMES		
VOLTAGES	208/230V		TQRYP2883BL41AN	TQRYP3123BL41AN	TQRYP3363BL41AN
		With 2 TQRYP1443AL41AN	With 1 TQRYP0723AL41AN and 1 TQRYP0963AL41AN	With 2 TQRYP1683AL41AN	
	460V		TQRYP2884BL41AN	TQRYP3124BL41AN	TQRYP3364BL41AN
		With 2 TQRYP1444AL41AN	With 1 TQRYP0724AL41AN and 1 TQRYP0964AL41AN	With 2 TQRYP1684AL41AN	
Power Source			208/230V, 3-Phase, 60Hz		
			460V, 3-Phase, 60Hz		
Capacity (Nominal) *1	Cooling	BTUH	288,000	312,000	336,000
	Heating	BTUH	275,000	297,000	320,000
Compressor	Operating Range		9% to 100%	9% to 100%	8% to 100%
	Type x Quantity		Refer to:	Refer to:	Refer to:
	Lubricant		TQRYP2884BL41AN	TQRYP0723AL41AN TQRYP0963AL41AN	TQRYP1683AL41AN
Circulating Water	Water Flow Rate	GPM (L/s)	TQRYP1444AL41AN	TQRYP0724AL41AN TQRYP0964AL41AN	TQRYP1684AL41AN
	Pressure Drop	Ft. (psi)			
	Max Water Pressure	psi (MPa)			
Refrigerant	Type		TQRYP1444AL41AN	TQRYP0724AL41AN TQRYP0964AL41AN	TQRYP1684AL41AN
External Finish					
Dimensions	Height	In.			
	Width	In.			
	Depth	In.			
Net Weight	Pounds		57	58	59
Sound Pressure Level (As Measured in an Anechoic Room)			dB(A)		
Protection Devices	High Pressure Protection		High pressure sensor, High pressure switch		
	Compressor/Fan		Overheat protection/Thermal switch		
	Inverter		Overheat and Overcurrent Protection		
Refrigerant Pipe Dimensions	Liquid (High Pressure) (Brazed)	In.	1-1/8		
	Gas (Low Pressure) (Brazed)	In.	1-3/8		
Indoor Unit Connectable	Total Capacity		50 to 150% of outdoor unit capacity		
	Model/Quantity		P06-P96/2-50 (Connectable branch pipe number is max. 48.)	P06-P96/2-50 (Connectable branch pipe number is max. 48.)	P06-P96/2-50 (Connectable branch pipe number is max. 48.)
Inlet Water Temperature Range	Cooling	50 to 113° F			
	Heating	50 to 113° F			
Efficiency Ratings (Ducted/ Non-Ducted) *4	EER	11.4/13.7	11.2/13.0	11.1/12.3	
	IEER	18.5/20.6	17.6/20.4	16.8/20.1	
	COP	4.90/5.25	4.78/5.24	4.66/5.23	

NOTES:

- *1 Rating Conditions:
Cooling | Indoor: 81° F (27° C) D.B./66° F (19° C) W.B.;
Water Temperature: 86° F (30° C)

Heating | Indoor: 68° F (20° C) D.B.; Water Temperature: 68° F (20° C).
- *2 Twinning kit is required for combining two individual outdoor units in the field for TQRYP**3(4)BL.
- *3 Each individual outdoor unit requires a separate electrical connection. Reference electrical data for each individual outdoor unit.
- *4 Efficiency values based on AHRI 1230 test method. Specifications are subject to change without notice.

LIMITED WARRANTY | Seven-year compressor and one year parts. Extended warranty of up to 10 years is available. See our website for details on specific additional application installation coverage.



TQHYP** (3/4)AL41AN

SPECIFICATIONS			MODEL NAMES				
VOLTAGE			208/230V	TQHYP0723AL41AN	TQHYP0963AL41AN	TQHYP1203AL41AN	TQHYP1443AL41AN
			460V	TQHYP0724AL41AN	TQHYP0964AL41AN	TQHYP1204AL41AN	TQHYP1444AL41AN
Power Source			208/230V, 3-Phase, 60Hz				
			460V, 3-Phase, 60Hz				
Capacity (Nominal) *1	Cooling	BTUH	72,000	96,000	120,000	144,000	
	Heating	BTUH	69,000	92,000	114,000	137,000	
Electrical Supply	MCA	A	13/12	19/17	29/26	35/32	
			6	9	13	16	
	MOP	A	20/20	30/25	50/45	60/50	
			15	15	20	25	
Compressor	Type x Quantity	INVERTER-driven Scroll Hermetic x 1					
	Operating Range	24% to 100%	18% to 100%	14% to 100%	19% to 100%		
	Lubricant	MEL32					
Circulating Water	Water Flow Rate	GPM (L/s)	25.4	25.4	25.4	31.7	
	Pressure Drop	Ft. (psi)	8 (3.48)	8 (3.48)	8 (3.48)	15 (6.38)	
	Max Water Pressure	psi (MPa)	290 (2)				
Refrigerant	Type	R410A					
External Finish			Galvanized steel sheets				
Dimensions	Height	In.	43-5/16			57-1/8	
	Width	In.	34-11/16				
	Depth	In.	21-11/16				
Net Weight	Pounds	375	474				
		400	501				
Sound Pressure Level (As Measured in an Anechoic Room)		dB(A)	46	48	54		
Protection Devices	High Pressure Protection		High pressure sensor, High pressure switch				
	Compressor		Over-heat protection, Over-current protection				
	Inverter		Over-heat protection				
Refrigerant Pipe Dimensions	Liquid (High Pressure) (Brazed)	In.	3/8	3/8 (1/2, total length >= 90 m)		1/2	
	Gas (Low Pressure) (Brazed)	In.	3/4	7/8		1-1/8	
Indoor Unit Connectable	Total Capacity		50 to 150% of water-source unit capacity				
	Model/Quantity		P06-P96/1-15	P06-P96/1-20	P06-P96/1-26	P06-P96/1-31	
Operating Temperature Range	Cooling	W.B.	Indoor: 59 to 75° F				
	Heating	D.B.	Indoor: 50 to 113° F				
Inlet Water Temperature Range	Cooling		50 to 113° F				
	Heating		50 to 113° F				
Efficiency Ratings (Ducted/ Non-Ducted) *2	EER		17.4/20.7	15.3/19.4	13.5/15.9	12.1/15.6	
	IEER		24.2/28.1	25.0/30.4	23.2/29.0	19.5/23.1	
	COP		5.62/6.15	5.80/6.02	5.55/5.66	4.92/5.56	

NOTES:
 *1 Rating Conditions: Cooling | Indoor: 81° F (27° C) D.B./66° F (19° C) W.B.;
 Water Temperature: 86° F (30° C) Heating | Indoor: 68° F (20° C) D.B.;
 Water Temperature: 68° F (20° C).
 Specifications are subject to change without notice.
 LIMITED WARRANTY | Seven-year compressor and one year parts. Extended warranty of up to 10 years is available. See our website for details on specific additional application installation coverage.

*2 Efficiency values based on AHRI 1230 test method.



TQHYP (3/4)AL41AN**

SPECIFICATIONS			MODEL NAMES			
VOLTAGE	208/230V		TQHYP1683AL41AN	TQHYP1923AL41AN	TQHYP2163AL41AN	TQHYP2403AL41AN
	460V		TQHYP1684AL41AN	TQHYP1924AL41AN	TQHYP2164AL41AN	TQHYP2404AL41AN
Power Source			208/230V, 3-Phase, 60Hz			
			460V, 3-Phase, 60Hz			
Capacity (Nominal) *1	Cooling	BTUH	168,000	192,000	216,000	240,000
	Heating	BTUH	161,000	183,000	206,000	228,000
Electrical Supply	MCA	A	44/39	54/49	69/63	79/71
			20	25	31	36
	MOP	A	70/70	90/80	110/110	125/125
			35	40	50	60
Compressor	Type x Quantity		INVERTER-driven Scroll Hermetic x 1			
	Operating Range		16% to 100%	14% to 100%	13% to 100%	12% to 100%
	Lubricant		MEL32			
Circulating Water	Water Flow Rate	GPM (L/s)	31.7	31.7	50.7	50.7
	Pressure Drop	Ft. (psi)	15 (6.38)	15 (6.38)	15 (6.53)	15 (6.53)
	Max Water Pressure	psi (MPa)	290 (2)			
Refrigerant	Type		R410A			
External Finish			Galvanized steel sheets			
Dimensions	Height	In.	57-1/8			
	Width	In.	34-11/16			
	Depth	In.	21-11/16			
Net Weight	Pounds		474		552	
			501		567	
Sound Pressure Level (As Measured in an Anechoic Room)		dB(A)	56	58		
Protection Devices	High Pressure Protection		High pressure sensor, High pressure switch			
	Compressor		Over-heat protection, Over-current protection			
	Inverter		Over-heat protection			
Refrigerant Pipe Dimensions	Liquid (High Pressure) (Brazed)	In.	5/8			
	Gas (Low Pressure) (Brazed)	In.	1-1/8			
Indoor Unit Connectable	Total Capacity		50 to 150% of water-source unit capacity			
	Model/Quantity		P06-P96/1-36	P06-P96/1-41	P06-P96/2-46	P06-P96/2-50
Operating Temperature Range	Cooling	W.B.	Indoor: 59 to 75° F			
	Heating	D.B.	Indoor: 50 to 113° F			
Inlet Water Temperature Range	Cooling		50 to 113° F			
	Heating		50 to 113° F			
Efficiency Ratings (Ducted/ Non-Ducted) *2	EER		15.2/19.0	12.0/13.6	15.0/17.3	11.5/12.5
	IEER		22.5/26.1	18.0/21.8	23.6/25.8	18.4/21.7
	COP		5.32/6.01	4.76/5.43	5.61/5.72	4.62/5.19

NOTES:

*1 Rating Conditions:

Cooling | Indoor: 81° F (27° C) D.B./66° F (19° C) W.B.; Water Temperature: 86° F (30° C)

Heating | Indoor: 68° F (20° C) D.B.; Water Temperature: 68° F (20° C).

*2 Efficiency values based on AHRI 1230 test method.

Specifications are subject to change without notice.

LIMITED WARRANTY | Seven-year compressor and one year parts. Extended warranty of up to 10 years is available. See our website for details on specific additional application installation coverage.



TQHYP (3/4) BL41AN**

SPECIFICATIONS			MODEL NAMES				
VOLTAGE	208/230V		TQHYP1443BL41AN With 2 TQHYP0723AL41AN	TQHYP1683BL41AN With 1 TQHYP0723AL41AN and TQHYP0963AL41AN	TQHYP1923BL41AN With 2 TQHYP0963AL41AN	TQHYP2163BL41AN With 1 TQHYP0963AL41AN and 1 TQHYP1203AL41AN	TQHYP2403BL41AN With 2 TQHYP1203AL41AN
		460V	TQHYP1444BL41AN With 2 TQHYP0724AL41AN	TQHYP1684BL41AN With 1 TQHYP0724AL41AN and 1 TQHYP0964AL41AN	TQHYP1924BL41AN With 2 TQHYP0964AL41AN	TQHYP2164BL41AN With 1 TQHYP0964AL41AN and 1 TQHYP1204AL41AN	TQHYP2404BL41AN With 2 TQHYP1204AL41AN
	Power Source						
	208/230V, 3-Phase, 60Hz 460V, 3-Phase, 60Hz						
Capacity (Nominal) *1	Cooling	BTUH	144,000	168,000	192,000	216,000	240,000
	Heating	BTUH	160,000	188,000	215,000	243,000	270,000
Compressor	Operating Range		12% to 100%	10% to 100%	9% to 100%	8% to 100%	7% to 100%
	Type x Quantity		Refer to: TQHYP0723AL41AN	Refer to: TQHYP0723AL41AN TQHYP0963AL41AN	Refer to: TQHYP0963AL41AN	Refer to: TQHYP0963AL41AN TQHYP1203AL41AN	Refer to: TQHYP1203AL41AN
	Lubricant						
Circulating Water	Water Flow Rate	GPM (L/s)					
	Pressure Drop	Ft. (psi)					
	Max Water Pressure	psi (MPa)					
Refrigerant	Type		TQHYP0724AL41AN	TQHYP0724AL41AN TQHYP0964AL41AN	TQHYP0964AL41AN	TQHYP0964AL41AN TQHYP1204AL41AN	TQHYP1204AL41AN
External Finish							
Dimensions	Height	In.					
	Width	In.					
	Depth	In.					
Net Weight	Pounds		49	50	51	55	57
Sound Pressure Level (As Measured in an Anechoic Room)		dB(A)	49	50	51	55	57
Protection Devices	High Pressure Protection		High pressure sensor, High pressure switch				
	Compressor/Fan		Overheat protection/Thermal switch				
	Inverter		Overheat and Overcurrent Protection				
Refrigerant Pipe Dimensions	Liquid (High Pressure) (Brazed)	In.	1/2	5/8			
	Gas (Low Pressure) (Brazed)	In.	1-1/8				
Indoor Unit Connectable	Total Capacity		50 to 150% of outdoor unit capacity				
	Model/Quantity		P06-P96/1-31	P06-P96/1-36	P06-P96/1-41	P06-P96/2-46	P06-P96/2-50
Inlet Water Temperature Range	Cooling		50 to 113° F				
	Heating		50 to 113° F				
Efficiency Ratings (Ducted/ Non-Ducted) *4	EER		14.5/16.4	11.3/10.9	13.6/15.0	10.8/11.0	12.5/13.9
	IEER		24.4/26.4	19.0/21.2	23.5/25.9	18.8/21.2	22.4/25.7
	COP		5.80/5.57	4.77/5.26	5.68/5.43	4.54/5.08	5.49/5.35

NOTES:

- *1 Rating Conditions:
Cooling | Indoor: 81° F (27° C) D.B./66° F (19° C) W.B.; Water Temperature: 86° F (30° C)
Heating | Indoor: 68° F (20° C) D.B.; Water Temperature: 68° F (20° C).
- *2 Twinning kit is required for combining two individual outdoor units in the field for TQRY-P(Y)SLMUA1.
- *3 Each individual outdoor unit requires a separate electrical connection. Reference electrical data for each individual outdoor unit.

*4 Efficiency values based on AHRI 1230 test method.

Specifications are subject to change without notice.
LIMITED WARRANTY | Seven-year compressor and one year parts. Extended warranty of up to 10 years is available. See our website for details on specific additional application installation coverage.



TQHYP** (3/4)BL41AN

SPECIFICATIONS			MODEL NAMES				
VOLTAGES	208/230V		TQHYP2883BL41AN	TQHYP3123BL41AN	TQHYP3363BL41AN	TQHYP3603BL41AN	
		With 2 TQHYP1443AL41AN	With 1 TQHYP1443AL41AN and 1 TQHYP1683AL41AN	With 2 T QHYYP1683AL41AN	With 1 TQHYP1683AL41AN and 1 TQHYP1923AL41AN		
	460V		TQHYP2884BL41AN	TQHYP3124BL41AN	TQHYP3364BL41AN	TQHYP3604BL41AN	
		With 2 TQHYP1444AL41AN	With 1 TQHYP1444AL41AN and 1 TQHYP1684AL41AN	With 2 TQHYP1684AL41AN	With 1 TQHYP1684AL41AN and 1 TQHYP1924AL41AN		
Power Source			208/230V, 3-Phase, 60Hz 460V, 3-Phase, 60Hz				
Capacity (Nominal) *1	Cooling	BTUH	288,000	312,000	336,000	360,000	
	Heating	BTUH	323,000	350,000	378,000	405,000	
Compressor	Operating Range		9% to 100%	9% to 100%	8% to 100%	8% to 100%	
	Type x Quantity		Refer to:	Refer to:	Refer to:	Refer to:	
	Lubricant						
Circulating Water	Water Flow Rate	GPM (L/s)	TQHYP1443AL41AN	TQHYP1443AL41AN TQHYP1683AL41AN	TQHYP1683AL41AN	TQHYP1683AL41AN TQHYP1923AL41AN	
	Pressure Drop	Ft. (psi)					
	Max Water Pressure	psi (MPa)					
Refrigerant	Type		TQHYP1444AL41AN	TQHYP1444AL41AN TQHYP1684AL41AN	TQHYP1684AL41AN	TQHYP1684AL41AN TQHYP1924AL41AN	
External Finish							
Dimensions	Height	In.					
	Width	In.					
	Depth	In.					
Net Weight			Pounds				
Sound Pressure Level (As Measured in an Anechoic Room)			dB(A)	57	58	59	60
Protection Devices	High Pressure Protection		High pressure sensor, High pressure switch				
	Compressor/Fan		Overheat protection/Thermal switch				
	Inverter		Overheat and Overcurrent Protection				
Refrigerant Pipe Dimensions	Liquid (High Pressure) (Brazed)	In.	3/4				
	Gas (Low Pressure) (Brazed)	In.	1-3/8		1-5/8		
Indoor Unit Connectable	Total Capacity		50 to 150% of outdoor unit capacity				
	Model/Quantity		P06-P96/2-50	P06-P96/2-50	P06-P96/2-50	P06-P96/2-50	
Inlet Water Temperature Range	Cooling		50 to 113° F				
	Heating		50 to 113° F				
Efficiency Ratings (Ducted/ Non-Ducted) *4	EER		11.4/13.8	11.2/13.0	11.1/12.3	11.2/12.1	
	IEER		18.5/20.6	17.6/20.4	16.8/20.1	17.5/20.3	
	COP		4.92/5.27	4.80/5.26	4.67/5.25	4.64/5.14	

NOTES:

*1 Rating Conditions:
Cooling | Indoor: 81° F (27° C) D.B./66° F (19° C) W.B.; Water Temperature: 86° F (30° C)
Heating | Indoor: 68° F (20° C) D.B.; Water Temperature: 68° F (20° C).
*2 Twinning kit is required for combining two individual outdoor units in the field for TQHYP*3(4)BL.
*3 Each individual outdoor unit requires a separate electrical connection. Reference electrical data for each individual outdoor unit.

*4 Efficiency values based on AHRI 1230 test method.

Specifications are subject to change without notice.
LIMITED WARRANTY | Seven-year compressor and one year parts. Extended warranty of up to 10 years is available. See our website for details on specific additional application installation coverage.



TPWFYPAU/BU**

Model Name			TPWFYP036AU141A	TPWFYP072AU141A	TPWFYP036BU140A
Power Source			208/230V, 1-phase, 60Hz		
Cooling Capacity *1	BTUH		36,200	72,000	-
Heating Capacity *1	BTUH		39,900	79,800	39,900
Power	Cooling	kW	0.025 – 0.028		N/A
	Heating	kW	0.025 – 0.028		2.48
Current	Cooling	A	0.145 – 0.150		N/A
	Heating	A	0.145 – 0.150		12.30 /11.12
External Finish			Galvanized-steel Sheet		
Dimensions	Height	In.	31-1/2		
	Width	In.	17-3/4		
	Depth	In.	11-13/16		
Net Weight	Unit	Pounds	73	80	133
Operating Outdoor Temperature Range	Cooling		23° F to 115° F D.B. (TURY/TUHY/TURYH)		-
	Heating		23° F to 109° F D.B. (TUHYH)		-
			-4 F to 90 F W.B. (TURY/TUHY)		-4 ° F to 90° F W.B.
			-13 F to 60 F W.B. (TURYHP/TUHYH)		
Circulating Water Operation Volume Range	GPM (L/m)		4.8 – 9.4 (18-36)	7.9 – 18.9 (30-72)	2.6 – 9.6 (10-36)
Circulating Water Design Pressure	MPa (psi)		1 (145)		
Water Piping Dimensions	Inlet	In.	3/4 FPT	1 FPT	3/4 FPT
	Outlet	In.	3/4 FPT	1 FPT	3/4 FPT
Refrigerant Pipe Dimensions	Liquid (High Pressure) (Brazed)	In.	3/8	3/8	3/8
	Gas (Low Pressure) (Brazed)	In.	5/8	3/4	5/8
Drainpipe Dimensions (O.D.)	In.		1-1/4		
Sound Pressure Levels	dB(A)		29		44
Connectable Outdoor Units			TURYP072 - 288(3/4)AN40A(N/B) TURYH072 - 192(3/4)AN40A(N/B) TUHYHP072 - 360(3/4)AN40A(N/B) TURYP072 - 336(3/4)AN40A(N/B) TQRYHP072 - 336(3/4)AL41AN(N/B) TUHYHP072 - 336(3/4)AN40A(N/B) TQHYHP072 - 360(3/4)AL41AN(N/B) TQHYHP072 - 360(3/4)AL41AN(N/B)		TURYP072 - 288(3/4)AN40A(N/B) TURYH072 - 192(3/4)AN40A(N/B) TURYP072 - 336(3/4)AN40A(N/B) TQRYHP072 - 336(3/4)AL41AN(N/B)

NOTES:
 *1 Nominal heating conditions (TPWFYP conditions are indicated in the parentheses).

(W-Series)
 Outdoor Temp.: 47° F D.B./43° F W.B. (8.3° C D.B./6.1° C W.B.)
 Pipe length: 25 ft (7.6 m)
 Level difference: 0 ft (0 m)
 (Inlet water Temp.: 149° F (65° C) Water flow rate: 9.4 gpm (2.15 m³/h))

(WR2-Series)
 Circulating water Temp.: 70° F (21.1° C)
 Pipe length: 25 ft (7.6 m)
 Level difference: 0 ft (0 m)
 (Inlet water Temp.: 149° F (65° C) Water flow rate 9.2 gpm (2.15 m³/h))

Note: Consult Application Note 2014 — Designing with TPWFYP for additional design assistance.

Note: The design water pressure drop and flow. Note that the pressure drop doesn't include strainers.

Specifications are subject to change without notice.
LIMITED WARRANTY | Seven-year compressor and one year parts. Extended warranty of up to 10 years is available. See our website for details on specific additional application installation coverage.



TPKFYP*** (B,H,K)M142(A,B)

Model Name			TPFYF 006BM142B	TPKFYP 008HM142A	TPKFYP 012HM142A	TPKFYP 015HM142A	TPKFYP 018KM142A	TPKFYP 024KM142A	TPKFYP 030KM142A	
Power Source			208/230V, 1-Phase, 60Hz							
Cooling Capacity		BTUH *1	6,000	8,000	12,000	15,000	18,000	24,000	30,000	
Heating Capacity		BTUH *1	6,700	9,000	13,500	17,000	20,000	27,000	34,000	
Power Consumption	Cooling	W	8	30				70		
	Heating	W	30	30				70		
Current	Cooling	A	0.15	.30				0.50		
	Heating	A	0.15	.30				0.50		
External Finish		Munsell No.	1.0Y 9.2/0.2							
Dimensions	Height	In.	11-5/8					14-3/8		
	Width	In.	32-1/8	35-3/8				46-1/16		
	Depth	In.	8-7/8	9-13/16				11-5/8		
Net Weight	Unit	Pounds	22	29				46		
Heat Exchanger			Cross Fin (Aluminum Plate Fin and Copper Tube)							
Fan	Type x Quantity		Line Flow Fan x 1							
	Airflow Rate *2	CFM	170-180-200-210	320-370-413			320-370-425	570-920	710-920	
	Motor Type		Single-phase Induction Motor	Direct-driven DC Motor						
Air Filter			Polypropylene Honeycomb							
Refrigerant Pipe Dimensions	Liquid (High Pressure) (Flare)	In.	1/4					3/8		
	Gas (Low Pressure) (Flare)	In.	1/2					5/8		
Drain Pipe Dimension (I.D.)		In.	5/8							
Sound Pressure Levels *2		dB(A)	32-33-35-36	34-39-43			36-41-45	39-49	43-49	

NOTES:

*1 Cooling/Heating Capacity indicates the maximum value at operation under the following conditions:

Cooling | Indoor: 80° F (27° C) D.B./67° F (19° C) W.B.; Outdoor: 95° F (35° C) D.B.

Heating | Indoor: 70° F (21° C) D.B.; Outdoor: 45° F (7° C) D.B./43° F (6° C) W.B.

*2 Airflow Rate/Sound Pressure Levels are at Lo-Mid1-Mid2-Hi, Lo-Mid-Hi, or Lo-Hi.

Specifications are subject to change without notice.

LIMITED WARRANTY | Seven-year compressor and one year parts. Extended warranty of up to 10 years is available. See our website for details on specific additional application installation coverage.



SPECIFICATIONS: TPLFYP ▼
CEILING-CASSETTE INDOOR UNIT

TPLFYP*EM140(1)A**

Model Name			TPLFYP006EM140A	TPLFYP008EM140A	TPLFYP012EM140A	TPLFYP015EM140A	TPLFYP018EM141A
Power Source			208/230V, 1-Phase, 60Hz				
Cooling Capacity		BTUH *1	6,000	8,000	12,000	15,000	18,000
Heating Capacity		BTUH *1	6,700	9,000	13,500	17,000	20,000
Power Consumption	Cooling	W	20	30	30	30	40
	Heating	W	20	20	20	20	40
Current	Cooling	A	0.19	0.31	0.31	0.31	0.43
	Heating	A	0.14	0.26	0.26	0.26	0.38
External Finish Color (Munsell No.)			MUNSELL (6.4Y 8.9/0.4)				
Dimensions	Height	In.	10-3/16	10-3/16	10-3/16	10-3/16	11-3/4
	Width	In.	33-3/32				
	Depth	In.	33-3/32				
Net Weight *2	Unit/Panel	Pounds	46 / 11	46 / 11	46 / 11	46 / 11	55 / 11
Heat Exchanger			Cross Fin (Aluminum Plate Fin and Copper Tube)				
Fan	Type x Quantity		Turbo Fan x 1				
	Airflow Rate *3	CFM	300 - 424 - 459 - 494	494 - 530 - 565 - 600	494 - 530 - 565 - 600	530 - 547 - 565 - 600	636 - 671 - 742 - 812
	Motor Type		DC Motor				
	Motor Output	W	50	50	50	50	120
Air Filter			PP honeycomb (long life filter, anti-bacterial type)				
Refrigerant Pipe Dimensions	Liquid (High Pressure) (Flare)	In.	1/4				
	Gas (Low Pressure) (Flare)	In.	1/2				
Drain Pipe Dimension (O.D.)		In.	1-1/4				
Sound Pressure Levels (As Measured in an Anechoic Room)*3	Low-Mid1-Mid2-High	dB(A)	19 - 23 - 25 - 27	27 - 29 - 30 - 31	27 - 29 - 30 - 31	28 - 29 - 30 - 31	28 - 30 - 32 - 34

Model Name			TPLFYP024EM140A	TPLFYP030EM140A	TPLFYP036EM140A	TPLFYP048EM140A
Power Source			208/230V, 1-Phase, 60Hz			
Cooling Capacity		BTUH *1	24,000	30,000	36,000	48,000
Heating Capacity		BTUH *1	27,000	34,000	40,000	54,000
Power Consumption	Cooling	W	40	40	70	110
	Heating	W	40	40	70	110
Current	Cooling	A	0.43	0.45	0.73	1.01
	Heating	A	0.38	0.40	0.68	0.96
External Finish Color (Munsell No.)			MUNSELL (6.4Y 8.9/0.4)			
Dimensions	Height	In.	11-3/4			
	Width	In.	33-3/32			
	Depth	In.	33-3/32			
Net Weight *2	Unit/Panel	Pounds	55 / 11			
Heat Exchanger			Cross Fin (Aluminum Plate Fin and Copper Tube)			
Fan	Type x Quantity		Turbo Fan x 1			
	Airflow Rate *3	CFM	636 - 671 - 742 - 812	636 - 706 - 777 - 812	777 - 883 - 989 - 1,095	777 - 953 - 1,095 - 1,236
	Motor Type		DC Motor			
	Motor Output	W	120			
Air Filter			PP honeycomb (long life filter, anti-bacterial type)			
Refrigerant Pipe Dimensions	Liquid (High Pressure) (Flare)	In.	3/8			
	Gas (Low Pressure) (Flare)	In.	5/8			
Drain Pipe Dimension (O.D.)		In.	1-1/4			
Sound Pressure Levels (As Measured in an Anechoic Room)*3	Low-Mid1-Mid2-High	dB(A)	28 - 30 - 32 - 34	28 - 31 - 33 - 35	35 - 37 - 39 - 41	36 - 39 - 42 - 45

NOTES:

- *1 Cooling/Heating capacity indicates the maximum value at operation under the following conditions:
 Cooling | Indoor: 80° F (26.7° C) DB/67° F (19.4° C) WB; Outdoor: 95° F (35° C) DB.
 Heating | Indoor: 70° F (21° C) DB; Outdoor: 47° F (8° C) DB/43° F (6° C) WB.
- *2 Net weight is shown for unit/grille.
- *3 Airflow rate/sound pressure levels are at (Low-Mid1-Mid2-High).

Ventilation Air: Providing sufficient ventilation air is an important part of every building design ASHRAE Standard 62 provides the minimum ventilation air requirements. Also check local codes.

Specifications are subject to change without notice.

LIMITED WARRANTY | Seven-year compressor and one year parts. Extended warranty of up to 10 years is available. See our website for details on specific additional application installation coverage.



TPLFYP*FM140A**

Model Name			TPLFYP005FM140A	TPLFYP008FM140A	TPLFYP012FM140A	TPLFYP015FM140A	TPLFYP018FM140A
Power Source			208/230V, 1-phase, 60Hz				
Cooling Capacity		BTUH *1	5,000	8,000	12,000	15,000	18,000
Heating Capacity		BTUH *1	5,600	9,000	13,500	17,000	20,000
Power Consumption	Cooling	W	20	20	20	30	40
	Heating	W	20	20	20	30	40
Current	Cooling	A	0.19	0.22	0.23	0.28	0.40
	Heating	A	0.14	0.17	0.18	0.23	0.35
External Finish (Munsell No.)			Grille: White (6.4Y 8.9/0.4)				
Dimensions	Height	In.	8-3/16				
	Width	In.	22-7/16				
	Depth	In.	22-7/16				
Net Weight *2	Unit/Panel	Pounds	28.9/5.3	28.9/5.3	31.3/5.3		
Heat Exchanger			Cross Fin (Aluminum Plate Fin and Copper Tube)				
Fan	Type x Quantity		Turbo Fan x 1				
	Airflow Rate *3	CFM	230-265-280	230-280-315	245-280-335	265-315-390	315-390-460
	Motor Type		Single-phase Induction Motor				
Air Filter			Polypropylene Honeycomb				
Refrigerant Pipe Dimensions	Liquid (High Pressure) (Flare)	In.	1/4				
	Gas (Low Pressure) (Flare)	In.	1/2				
Condensate Lift Mechanism (Standard)		In.	19-11/16				
Drain Pipe Dimension (O.D.)		In.	1-1/4				
Sound Pressure Levels (As Measured in an Anechoic Room) *3	(Low-Mid-High)	dB(A)	26-28-30	26-30-33	26-30-34	28-33-39	33-39-43

NOTES:

- *1 Cooling/Heating capacity indicates the maximum value at operation under the following conditions:
Cooling | Indoor: 80° F (27° C) D.B./67° F (19° C) W.B.; Outdoor: 95° F (35° C) D.B.
Heating | Indoor: 70° F (21° C) D.B.; Outdoor: 47° F (8° C) D.B./43° F (6° C) W.B.
- *2 Net weight is shown for unit/grille.
- *3 Airflow rate/sound pressure levels are at (Low-Mid-High).

Ventilation Air: Providing sufficient ventilation air is an important part of every building design. ASHRAE Standard 62 provides the minimum ventilation air requirements. Also check local codes.

Specifications are subject to change without notice.
LIMITED WARRANTY | Seven-year compressor and one year parts. Extended warranty of up to 10 years is available. See our website for details on specific additional application installation coverage.



TPMFYF*BM140F**

Model Name		TPMFYF006BM140F	TPMFYF008BM140F	TPMFYF012BM140F	TPMFYF015BM140F	
Power Source		208/230V, 1-phase, 60Hz				
Cooling Capacity	BTUH *1	6,000	8,000	12,000	15,000	
Heating Capacity	BTUH *1	6,700	9,000	13,500	17,000	
Power Consumption	Cooling	W	40		50	
	Heating	W	40		50	
Current	Cooling	A	0.20		0.26	
	Heating	A	0.20		0.26	
External Finish Color (Munsell No.)		Grille: 6.4Y 8.9/0.4				
Dimensions	Height	In.	9-1/16			
	Width	In.	31-31/32			
	Depth	In.	15-9/16			
Net Weight	Unit	Pounds	31			
Heat Exchanger		Cross Fin				
Fan	Type x Quantity		Line flow fan x 1			
	Airflow Rate *2	CFM	230-254-283-307	258-283-304-328	272-307-343-378	
	Motor Type		DC Brushless Motor			
Air Filter		Polypropylene Honeycomb				
Refrigerant Pipe Dimensions	Liquid (High Pressure) (Flare)	In.	1/4			
	Gas (Low Pressure) (Flare)	In.	1/2			
Condensate Lift Mechanism (Standard)		In.	23-5/8			
Drain Pipe Dimension (O.D.)		In.	1			
Sound Pressure Levels (As Measured in an Anechoic Room) *2	(Low-Mid1-Mid2-High)	dB(A)	27-30-33-35	32-34-36-37	32-34-36-37	33-35-37-39

NOTES:

*1 Cooling/Heating capacity indicates the maximum value at operation under the following conditions:
 Cooling | Indoor: 80° F (27° C) D.B./67° F (19° C) W.B.; Outdoor: 95° F (35° C) D.B.
 Heating | Indoor: 70° F (21° C) D.B.; Outdoor: 47° F (8° C) DB/43° F (6° C) W.B.

*2 Airflow rate/sound levels are at (Low-Mid1-Mid2-High).

Ventilation Air: Providing sufficient ventilation air is an important part of every building design.

ASHRAE standard 62 provides the minimum ventilation air requirements. Also check local codes.

Specifications are subject to change without notice.
LIMITED WARRANTY | Seven-year compressor and one year parts. Extended warranty of up to 10 years is available. See our website for details on specific additional application installation coverage.



TPCFYP***KM140B

Model Name			TPCFYP015KM140B	TPCFYP024KM140B	TPCFYP030KM140B	TPCFYP036KM140B
Power Source			208/230V, 1 Phase, 60Hz			
Cooling Capacity		BTUH *1	15,000	24,000	30,000	36,000
Heating Capacity		BTUH *1	17,000	27,000	34,000	40,000
Power Consumption	Cooling	W	30	40	90	110
	Heating	W	30	40	90	110
Current	Cooling	A	0.35	0.41	0.83	0.97
	Heating	A	0.35	0.41	0.83	0.97
External Finish		Munsell No.	6.4Y 8.9/0.4			
Dimensions	Height	In.	9-1/16			
	Width	In.	37-13/16	50-3/8	63	
	Depth	In.	26-3/4			
Net Weight	Unit	Pounds	53	71	79	84
Heat Exchanger			Cross Fin (Aluminum Plate Fin and Copper Tube)			
Fan	Type x quantity		Sirocco Fan x 2	Sirocco Fan x 3	Sirocco Fan x 4	
	Airflow Rate *2	CFM	353-388-424-459	494-530-565-636	703-777-883-989	742-847-953-1,095
	Motor Type		Direct-driven DC Motor			
Air Filter			Polypropylene Honeycomb			
Refrigerant Pipe Dimensions	Liquid (High Pressure) (Flare)	In.	1/4	3/8		
	Gas (Low Pressure) (Flare)	In.	1/2	5/8		
Drain Pipe Dimension (O.D.)		In.	1			
Sound Pressure Levels *2	Lo-Mid1-Mid2-Hi	dB(A)	29-32-34-36	31-33-35-37	34-37-40-43	36-39-42-44

NOTES:

*1 Cooling/Heating Capacity indicates the maximum value at operation under the following conditions:
 Cooling | Indoor: 80° F (27° C) D.B./67° F (19° C) W.B.; Outdoor: 95° F (35° C) D.B.
 Heating | Indoor: 70° F (21° C) D.B.; Outdoor: 45° F (7° C) D.B./43° F (6° C) W.B.

*2 Airflow rate/sound pressure levels are at Low-Mid1-Mid2-Hi.

Ventilation Air: Providing sufficient ventilation air is an important part of every building design. ASHRAE Standard 62 provides the minimum air requirements. Also check local codes.

Specifications are subject to change without notice.
 LIMITED WARRANTY | Seven-year compressor and one year parts. Extended warranty of up to 10 years is available. See our website for details on specific additional application installation coverage.

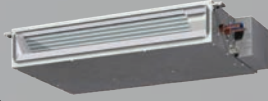

SPECIFICATIONS: TPEFY ▼

CEILING-CONCEALED INDOOR UNIT

TPEFY*MS140C**

Model Name			TPEFY006MS140C	TPEFY008MS140C	TPEFY012MS140C	TPEFY015MS140C	TPEFY018MS140C	TPEFY024MS140C	
Power Source			208/230V, 1-phase, 60Hz						
Cooling Capacity *2		BTUH	6,000	8,000	12,000	15,000	18,000	24,000	
Heating Capacity *2		BTUH	6,700	9,000	13,500	17,000	20,000	27,000	
Power Consumption	Cooling	W	50/50	60/60	70/70		90/90	120/120	
	Heating	W	30/30	40/40	50/50		70/70	100/100	
Current	Cooling	A	0.42/0.41	0.51/0.49	0.56/0.53	0.57/0.55	0.74/0.70	0.98/0.93	
	Heating	A	0.32/0.31	0.41/0.39	0.46/0.43	0.47/0.45	0.64/0.60	0.88/0.83	
External Finish			Galvanized Steel Sheets						
Dimensions	Height	In.	7-7/8						
	Width	In.	31-1/8			39		46-7/8	
	Depth	In.	27-9/16						
Net Weight	Unit	Pounds	42	46	54	62			
Heat Exchanger			Cross Fin (Aluminum Plate Fin and Copper Tube)						
Fan	Type x Quantity		Sirocco Fan x 2			Sirocco Fan x 3		Sirocco Fan x 4	
	Airflow Rate *3	CFM	176-212-247	194-247-317	211-282-370	282-335-388	353-441-529	423-565-706	
	External Static Pressure *4	In. W.G.	0.02-0.06-0.14-0.20						
	Motor Type		DC Brushless Motor						
Air Filter			Polypropylene Honeycomb Fabric (washable)						
Refrigerant Pipe Dimensions	Liquid (High Pressure) (Braze)	In.	1/4					3/8	
	Gas (Low Pressure) (Braze)	In.	1/2					5/8	
Condensate Lift Mechanism (standard)		In.	21-4/16						
Drain Pipe Dimensions (O.D.)		In.	1-1/4						
Sound Pressure Levels *3	Low-Mid-High	dB(A)	22-24-28	23-26-30	23-28-35	28-30-33	30-34-37	30-35-40	

NOTES:

- *1 Not compatible with TUHY/TURYP-TGMU or TQHY/TQRYT-TGMU units.
- *2 Cooling/Heating capacity indicates the maximum value at operation under the following conditions:
Cooling | Indoor: 80° F (27° C) D.B./67° F (19° C) W.B.; Outdoor: 95° F (35° C) D.B.
Heating | Indoor: 70° F (21° C) D.B.; Outdoor: 47° F (8° C) D.B./43° F (6° C) W.B.
- *3 Airflow rate/sound pressure levels are at (Low-Mid-High).
- *4 External static pressure is factory set to 0.06" W.G.

Ventilation Air: Providing sufficient ventilation air is an important part of every building design ASHRAE Standard 62 provides the minimum air requirements. Also check local codes.

Specifications are subject to change without notice.
LIMITED WARRANTY | Seven-year compressor and one year parts. Extended warranty of up to 10 years is available. See our website for details on specific additional application installation coverage.

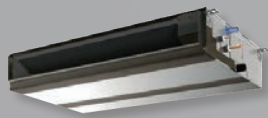

TPEFYP***MA143A

Model Name			TPEFYP006MA143A	TPEFYP008MA143A	TPEFYP012MA143A	TPEFYP015MA143A	TPEFYP018MA143A	TPEFYP024MA143A
Power Source			208/230V, 1-Phase, 60Hz					
Cooling Capacity		BTUH *1	6,000	8,000	12,000	15,000	18,000	24,000
Heating Capacity		BTUH *1	6,700	9,000	13,500	17,000	20,000	27,000
Power Consumption	Cooling	W	60		90		110	170
	Heating	W	40		70		90	150
Current	Cooling	A	0.56/0.52		0.66/0.62	0.67/0.63	0.77/0.73	1.31/1.27
	Heating	A	0.45/0.41		0.55/0.51	0.56/0.52	0.66/0.62	1.20/1.16
External Finish			Galvanized Steel Sheet					
Dimensions	Height	In.	9-7/8					
	Width	In.	27-9/16			35-7/16		43-5/16
	Depth	In.	28-7/8					
Net Weight	Unit	Pounds	49			58	67	
Heat Exchanger			Cross Fin (Aluminum plate fin and copper tube)					
Fan	Type x Quantity		Sirocco Fan x 1					Sirocco Fan x 2
	Airflow Rate *2	CFM	212-265-300		265-318-371	353-424-494	424-512-600	618-742-883
	External Static Pressure	In. W.G.	0.14-0.20-0.28-0.40-0.60					
	Motor Type		Direct-driven DC Brushless Motor					
Air Filter			Polypropylene Honeycomb					
Refrigerant Pipe Dimensions	Liquid (High Pressure) (Brazed)	In.	1/4					3/8
	Gas (Low Pressure) (Brazed)	In.	1/2					5/8
Drain Pipe Dimension (O.D.)		In.	1-1/4"					
Sound Pressure Levels	Lo-Mid-Hi	dB(A)	26-28-29		28-30-34		26-28-29	

Model Name			TPEFYP027MA143A	TPEFYP030MA143A	TPEFYP036MA143A	TPEFYP048MA143A	TPEFYP054MA143A	
Power Source			208/230V, 1-Phase, 60Hz					
Cooling Capacity		BTUH *1	27,000	30,000	36,000	48,000	54,000	
Heating Capacity		BTUH *1	30,000	34,000	40,000	54,000	60,000	
Power Consumption	Cooling	W	170		240	340	360	
	Heating	W	150		220	320	340	
Current	Cooling	A	1.31/1.27		1.50/1.46	2.08/2.04	2.24/2.2	
	Heating	A	1.20/1.16		1.39/1.35	1.97/1.93	2.13/2.09	
External Finish			Galvanized Steel Sheet					
Dimensions	Height	In.	9-7/8					
	Width	In.	43-5/16			55-1/8		63
	Depth	In.	28-7/8					
Net Weight	Unit	Pounds	67		86		93	
Heat Exchanger			Cross Fin (Aluminum plate fin and copper tube)					
Fan	Type x Quantity		Sirocco Fan x 2					
	Airflow Rate *2	CFM	618-742-883		812-989-1,165	989-1,201-1,412	1,042-1,254-1,483	
	External Static Pressure	In. W.G.	0.14-0.20-0.28-0.40-0.60					
	Extended Static Motor Type		Direct-driven DC Brushless Motor					
Air Filter			Polypropylene Honeycomb					
Refrigerant Pipe Dimensions	Liquid (High Pressure) (Brazed)	In.	3/8					
	Gas (Low Pressure) (Brazed)	In.	5/8					
Drain Pipe Dimension (O.D.)		In.	1-1/4"					
Sound Pressure Levels	Lo-Mid-Hi	dB(A)	28-30-34v		32-37-41	35-40-44	36-41-45	

NOTES:

*1 Cooling/Heating Capacity indicates the maximum value at operation under the following conditions:
 Cooling | Indoor: 80° F (27° C) D.B./67° F (19° C) W.B.; Outdoor 95° F (35° C) D.B.
 Heating | Indoor: 70° F (21° C) D.B.; Outdoor: 45° F (7° C) D.B./43° F (6° C) W.B.

*2 Airflow rate/sound pressure levels are at Low-Mid-Hi.

Ventilation Air: Providing sufficient ventilation air is an important part of very building design ASHRAE Standard 62 provides the minimum air requirements. Also check local codes.

Specifications are subject to change without notice.
 LIMITED WARRANTY | Seven-year compressor and one year parts. Extended warranty of up to 10 years is available. See our website for details on specific additional application installation coverage.



TPEFYP***MH142A

Model Name			TPEFYP015MH142A	TPEFYP018MH142A	TPEFYP024MH142A	TPEFYP027MH142A	TPEFYP030MH142A
Power Source			208/230V, 1-phase, 60Hz				
Cooling Capacity *1		BTUH	15,000	18,000	24,000	27,000	30,000
Heating Capacity *1		BTUH	17,000	20,000	27,000	30,000	34,000
Power Consumption	Cooling	W	270/280	270/280	330/320	390	450
	Heating	W	250/260	250/260	310/300	370	430
Current	Cooling	A	1.32/1.25	1.32/1.25	1.61/1.43	1.90/1.73	2.20/2.00
	Heating	A	1.21/1.14	1.21/1.14	1.50/1.32	1.79/1.62	2.09/1.89
External Finish			Unit: Galvanized Steel Plate				
Dimensions	Height	In.	15	15	15	15	15
	Width	In.	29-3/8	29-3/8	29-3/8	40-9/16	40-9/16
	Depth	In.	35-7/16	35-7/16	35-7/16	35-7/16	35-7/16
Net Weight	Unit	Pounds	98	98	100	124	124
Heat Exchanger			Cross Fin (Aluminum Plate Fin and Copper Tube)				
Fan	Type x Quantity		Sirocco Fan x 1	Sirocco Fan x 1	Sirocco Fan x 1	Sirocco Fan x 1	Sirocco Fan x 2
	Airflow Rate *2	CFM	353-494	353-494	477-671	547-777	636-883
	Ext. Static Pressure (208/230V)	In. W.G.	0.40-1.00/0.60-1.00				
	Motor Type		Single-phase Induction Motor				
Air Filter			Optional Part				
Refrigerant Pipe Dimensions	Liquid (High Pressure) (Flare)	In.	1/4	1/4	3/8	3/8	3/8
	Gas (Low Pressure) (Flare)	In.	1/2	1/2	5/8	5/8	5/8
Drain Pipe Dimension (O.D.)		In.	1-1/4	1-1/4	1-1/4	1-1/4	1-1/4
Sound Pressure Levels (Low-High) *2		dB(A) at 230V	39-45	39-45	40-46	38-44	38-43

Model Name			TPEFYP036MH142A	TPEFYP048MH142A	TPEFYP054MH142A	TPEFYP072MH142A	TPEFYP096MH142A	
Power Source			208/230V, 1-phase, 60Hz					
Cooling Capacity *1		BTUH	36,000	48,000	54,000	72,000	96,000	
Heating Capacity *1		BTUH	40,000	54,000	60,000	80,000	108,000	
Power Consumption	Cooling	W	620/610	620/610	630/620	63	82	
	Heating	W	600/590	600/590	610/600	63	82	
Current	Cooling	A	3.10/2.74	3.10/2.74	3.11/2.78	3.67/3.32	4.89/4.43	
	Heating	A	2.99/2.63	2.99/2.63	3.00/2.67	3.67/3.32	4.89/4.43	
External Finish			Unit: Galvanized Steel Plate					
Dimensions	Height	In.	15	15	15	18-9/16		
	Width	In.	47-1/16	47-1/16	47-1/16	49-1/4		
	Depth	In.	35-7/16	35-7/16	35-7/16	44-1/8		
Net Weight	Unit	Pounds	153	153	157	214	221	
Heat Exchanger			Cross Fin (Aluminum Plate Fin and Copper Tube)					
Fan	Type x Quantity		Sirocco Fan x 2	Sirocco Fan x 2	Sirocco Fan x 2	Sirocco Fan x 2	Sirocco Fan x 2	
	Airflow Rate *2	CFM	936-1,342	936-1,342	989-1,412	1,766-2,154-2,542	2,048-2,507-2,966	
	Ext. Static Pressure (208/230V)	In. W.G.	0.40-1.00/0.60-1.00				0.20-0.40-0.60-0.80-1.00	
	Motor Type		Single-phase Induction Motor				DC Motor	
Air Filter			Optional Part					
Refrigerant Pipe Dimensions	Liquid (High Pressure)	In.	3/8 (Flare)	3/8 (Flare)	3/8 (Flare)	3/8 (Brazed)	3/8 (Brazed)	
	Gas (Low Pressure)	In.	5/8 (Flare)	5/8 (Flare)	5/8 (Flare)	3/4 (Brazed)	7/8 (Brazed)	
Drain Pipe Dimension (O.D.)		In.	1-1/4	1-1/4	1-1/4	1-1/4	1-1/4	
Sound Levels *2 (Low-High or Low-Mid-High)		dB(A) at 230V	40-46	40-46	41-47	36-39-43	39-42-46	

NOTES:

*1 Cooling/Heating capacity indicates the maximum value at operation under the following conditions:

Cooling | Indoor: 80° F (27° C) D.B./67° F (19° C) W.B.; Outdoor: 95° F (35° C) D.B.
 Heating | Indoor: 70° F (21° C) D.B.; Outdoor: 47° F (8° C) D.B./43° F (6° C) W.B.

*2 Airflow rate/sound levels are at (Low-High or Low-Mid-High).

Ventilation Air: Providing sufficient ventilation air is an important part of every building design.

ASHRAE standard 62 provides the minimum ventilation air requirements.

Also check local codes.

Specifications are subject to change without notice.

LIMITED WARRANTY | Seven-year compressor and one year parts. Extended warranty of up to 10 years is available. See our website for details on specific additional application installation coverage.

TPFFYP*** (CS/RE)140A



Model			TPFFYP006CS140A	TPFFYP008CS140A	TPFFYP012CS140A	TPFFYP015CS140A	TPFFYP018CS140A	TPFFYP024CS140A	
Power Source			208/230V, 1 Phase, 60Hz						
Cooling Capacity		BTUH *1	6,000	8,000	12,000	15,000	18,000	24,000	
Heating Capacity		BTUH *1	6,700	9,000	13,500	17,000	20,000	27,000	
Power Consumption	Cooling	W	51/61	51/61	55/67	65/78	78/93	96/114	
	Heating	W	51/61	51/61	55/67	65/78	78/93	96/114	
Current	Cooling	A	0.25/0.27	0.25/0.27	0.27/0.30	0.32/0.35	0.38/0.42	0.47/0.51	
	Heating	A	0.25/0.27	0.25/0.27	0.27/0.30	0.32/0.35	0.38/0.42	0.47/0.51	
External Finish (Munsell No.)			Acrylic Painted (5Y 8/1)						
Dimensions	Height	In.	24-13/16	24-13/16	24-13/16	24-13/16	24-13/16	24-13/16	
	Width	In.	41-11/32	41-11/32	46-3/32	46-3/32	55-17/32	55-17/32	
	Depth	In.	8-11/16	8-11/16	8-11/16	8-11/16	8-11/16	8-11/16	
Net Weight	Unit	Pounds	67	67	71	73	84	89	
Heat Exchanger			Cross Fin (Aluminum Plate Fin and Copper Tube)						
Fan	Type x Quantity		Sirocco Fan x 1	Sirocco Fan x 1	Sirocco Fan x 2	Sirocco Fan x 2	Sirocco Fan x 2	Sirocco Fan x 2	
	Airflow Rate *2		CFM	194-229	194-229	247-317	300-388	353-459	353-494
	Motor Type		Single Phase Induction Motor						
	Motor Output		W	15	15	18	30	35	63
Air Filter			Standard Filter						
Refrigerant Pipe Dimension	Liquid (High Pressure) (Flare)	In.	1/4	1/4	1/4	1/4	1/4	3/8	
	Gas (Low Pressure) (Flare)	In.	1/2	1/2	1/2	1/2	1/2	5/8	
Drain Pipe Dimension			In. O.D. 1-3/32						
Sound Levels *2	(Low-High)	dB(A)	36-41	36-41	37-41	38-43	38-43	40-46	

NOTES:

*1 Cooling/Heating capacity indicates the maximum value at operation under the following conditions:
 Cooling | Indoor: 80° F (27° C) D.B./67° F (19° C) W.B. ; Outdoor: 95° F (35° C) D.B.
 Heating | Indoor: 70° F (21° C) D.B. ; Outdoor: 45° F (7° C) DB/43° F (6° C) W.B.

*2 Airflow rate/sound levels are at (Low-High)

Ventilation Air: Providing sufficient ventilation air is an important part of every building design
 ASHRAE standard 62 provides the minimum ventilation air requirements.
 Also check local codes.

Specifications are subject to change without notice.

LIMITED WARRANTY | Seven-year compressor and one year parts. Extended warranty of up to 10 years is available. See our website for details on specific additional application installation coverage.



Model			TPFFYP006RE140A	TPFFYP008RE140A	TPFFYP012RE140A	TPFFYP015RE140A	TPFFYP018RE140A	TPFFYP024RE140A	
Power Source			208/230V, 1 Phase, 60Hz						
Cooling Capacity		BTUH *1	6,000	8,000	12,000	15,000	18,000	24,000	
Heating Capacity		BTUH *1	6,700	9,000	13,500	17,000	20,000	27,000	
Power Consumption	Cooling	W	51/61	51/61	55/67	65/78	78/93	96/114	
	Heating	W	51/61	51/61	55/67	65/78	78/93	96/114	
Current	Cooling	A	0.25/0.27	0.25/0.27	0.27/0.30	0.32/0.35	0.38/0.42	0.47/0.51	
	Heating	A	0.25/0.27	0.25/0.27	0.27/0.30	0.32/0.35	0.38/0.42	0.47/0.51	
External Finish (Munsell No.)			Galvanized Sheet Metal						
Dimensions	Height	In.	25-3/16	25-3/16	25-3/16	25-3/16	25-3/16	25-3/16	
	Width	In.	34-29/32	34-29/32	39-5/8	39-5/8	49-1/16	49-1/16	
	Depth	In.	8-11/16	8-11/16	8-11/16	8-11/16	8-11/16	8-11/16	
Net Weight	Unit	Pounds	51	51	58	60	69	71	
Heat Exchanger			Cross Fin (Aluminum Plate Fin and Copper Tube)						
Fan	Type x Quantity		Sirocco Fan x 1	Sirocco Fan x 1	Sirocco Fan x 2	Sirocco Fan x 2	Sirocco Fan x 2	Sirocco Fan x 2	
	Airflow Rate *2		CFM	194-229	194-229	247-317	300-388	353-459	353-494
	Motor Type		Single Phase Induction Motor						
	Motor Output		kW	0.015	0.015	0.018	0.030	0.035	0.063
Air Filter			Standard Filter						
Refrigerant Pipe Dimension	Liquid (High Pressure) (Flare)	In.	1/4	1/4	1/4	1/4	1/4	3/8	
	Gas (Low Pressure) (Flare)	In.	1/2	1/2	1/2	1/2	1/2	5/8	
Drain Pipe Dimension			In. O.D. 1-3/32						
Sound Levels *2	(Low-High)	dB(A)	36-41	36-41	37-41	38-43	38-43	40-46	

NOTES:

*1 Cooling/Heating capacity indicates the maximum value at operation under the following conditions:
 Cooling | Indoor: 80° F (27° C) D.B./67° F (19° C) W.B. ; Outdoor: 95° F (35° C) D.B.
 Heating | Indoor: 70° F (21° C) D.B. ; Outdoor: 45° F (7° C) D.B./43° F (6° C) W.B.

*2 Airflow rate/sound levels are at (Low-High)

Ventilation Air: Providing sufficient ventilation air is an important part of every building design
 ASHRAE standard 62 provides the minimum ventilation air requirements. Also check local codes.
 Specifications are subject to change without notice.

LIMITED WARRANTY | Seven-year compressor and one year parts. Extended warranty of up to 10 years is available. See our website for details on specific additional application installation coverage.



TPVFYP***AM141A

Model Name			TPVFYP 012AM140A	TPVFYP 018AM140A	TPVFYP 024AM141A	TPVFYP 030AM141A	TPVFYP 036AM141A	TPVFYP 048AM141A	TPVFYP 054AM141A
Power Source			208/230V, 1-phase, 60Hz						
Cooling Capacity	BTUH *1		12,000	18,000	24,000	30,000	36,000	48,000	54,000
Heating Capacity	BTUH *1		13,500	20,000	27,000	34,000	40,000	54,000	60,000
Dimensions	Height	In.	50-1/4			54-1/4		59-1/2	
	Width	In.	17			21		25	
	Depth	In.	21-5/8						
Net Weight	Unit	Pounds	113			141		172	
Heat Exchanger			Cross fin (Aluminum fin and copper tube)						
Fan	Type x Qty.		Sirocco fan x 1						
	Airflow Rate *2	CFM	280 – 340 – 400	410 – 497 – 585	515 – 625 – 735	613 – 744 – 875	767 – 931 – 1,095	980 – 1,190 – 1,400	1,040 – 1,262 – 1,485
	External Static Pressure	In. W.G.	0.30 – 0.50 – 0.80 (selectable)						
	Motor Type		DC motor						
Filter			Polypropylene Honeycomb						
Refrigerant Pipe Dimensions	Liquid (High Pressure) (Braze)	In.	1/4			3/8			
	Gas (Low Pressure) (Braze)	In.	1/2			5/8			
Drain Pipe Dimensions		In.	3/4 FPT						
Sound Pressure Levels (As Measured in an Anechoic Room) *2	Pressure	dB(A)	27 – 31 – 35	28 – 32 – 36	30 – 34 – 38	32 – 36 – 40	35 – 39 – 43	35 – 39 – 43	36 – 40 – 44

NOTES:

*1 Cooling/Heating capacity indicates the maximum value at operation under the following conditions:
 Cooling | Indoor: 80° F (27° C) D.B./67° F (19° C) W.B.; Outdoor: 95° F (35° C) D.B.
 Heating | Indoor: 70° F (21° C) D.B.; Outdoor: 47° F (8° C) D.B./43° F (6° C) W.B.

*2 Airflow rate/sound pressure levels are at (Low-Med-High).

Ventilation Air: Providing sufficient ventilation air is an important part of every building design. ASHRAE standard 62 provides the minimum ventilation air requirements. Also check local codes.

Specifications are subject to change without notice.
 LIMITED WARRANTY | Seven-year compressor and one year parts. Extended warranty of up to 10 years is available. See our website for details on specific additional application installation coverage.

A modern office interior with large windows and plants. The scene is brightly lit, with a curved ceiling and a polished floor. Several potted plants are visible, and there are colorful chairs (red, orange, blue) and a dark table in the foreground. The background shows a multi-story building with a glass facade and a balcony with a railing.

VENTILATION SPECIFICATIONS

Lossnay® Energy Recovery Ventilators (ERVs)/DOAS



TLGHF***1RX501A

Model Name		TLGHF03001RX501A							
Power source		208/230V, 1-phase, 60Hz							
Ventilation mode		Lossnay ventilation				Bypass ventilation			
Speed		Extra high	High	Low	Extra Low	Extra high	High	Low	Extra Low
Current	A	1.33/1.35	1.12/1.18	0.81/0.86	0.32/0.36	1.33/1.35	1.12/1.18	0.81/0.86	0.32/0.36
Input	W	274/300	232/268	168/197	67/82	274/300	232/268	168/197	67/82
Air volume	CFM	300/300	260/300	203/235	91/112	300/300	260/300	203/235	91/112
External static pressure	In. W.G.	0.60/0.78	0.46/0.54	0.28/0.33	0.06/0.08	0.60/0.78	0.46/0.54	0.28/0.33	0.06/0.08
Temperature recovery efficiency (%)		65.5/65.5	67.5/65.5	71/69	81/79	-	-	-	-
Enthalpy recovery efficiency (%)	Heating	63/63	65/63	68/66	79/77	-	-	-	-
	Cooling	50/50	52/50	55/53	63/61	-	-	-	-
Sound Pressure (Measured at 1.5m under level the center of the unit)	dB(A)	34/37	30.5/33	25.5/27.5	18/18	35/37.5	31.5/34.5	25.5/28.5	18/18.5
Weight	Pounds	73							
Starting current		2.5A							
Filter Specification		Standard Filter Provided (MERV 6)							

Model Name		TLGHF04701RX501A							
Power source		208/230V, 1-phase, 60Hz							
Ventilation mode		Lossnay ventilation				Bypass ventilation			
Speed		Extra high	High	Low	Extra Low	Extra high	High	Low	Extra Low
Current	A	2.40/2.50	2.10/2.20	1.59/1.71	0.60/0.64	2.40/2.50	2.10/2.20	1.59/1.71	0.60/0.64
Input	W	485/538	425/490	330/393	120/145	485/538	425/490	330/393	120/145
Air volume	CFM	470/470	420/470	330/365	147/177	470/470	420/470	330/365	147/177
External static pressure	In. W.G.	0.80/0.96	0.54/0.66	0.33/0.40	0.07/0.09	0.80/0.96	0.54/0.66	0.33/0.40	0.07/0.09
Temperature recovery efficiency (%)		69/69	70.5/69	74/72	82/80	-	-	-	-
Enthalpy recovery efficiency (%)	Heating	64/64	66/64	70/68	80/78	-	-	-	-
	Cooling	51/51	53/51	58/55	69/67	-	-	-	-
Sound Pressure (Measured at 1.5m under level the center of the unit)	dB(A)	36/38	33/35.5	28.5/31	18/18.5	36/39	33/36	28.5/31.5	18/18
Weight	Pounds	119							
Starting current		4.5A							
Filter Specification		Standard Filter Provided (MERV 6)							

Specifications are subject to change without notice.

LIMITED WARRANTY | Seven-year compressor and one year parts. Extended warranty of up to 10 years is available. See our website for details on specific additional application installation coverage.

LGH-F***RX5-E1

Model		TLGHF06001RX501A							
Power source		208/230V, 1-phase, 60Hz							
Ventilation mode		Lossnay ventilation				Bypass ventilation			
Speed		Extra high	High	Low	Extra Low	Extra high	High	Low	Extra Low
Current	A	2.80/2.90	2.50/2.70	1.56/1.69	0.72/0.79	2.80/2.90	2.50/2.70	1.56/1.69	0.72/0.79
Input	W	577/637	517/605	324/387	146/180	577/637	517/605	324/387	146/180
Air volume	CFM	600/600	520/600	370/430	200/235	600/600	520/600	370/430	200/235
External static pressure	In. W.G.	0.56/0.80	0.48/0.48	0.24/0.24	0.07/0.07	0.56/0.80	0.48/0.48	0.24/0.24	0.07/0.07
Temperature recovery efficiency (%)		67/67	68/67	75/73	80/78	-	-	-	-
Enthalpy recovery efficiency (%)		Heating	64/64	65/64	71/68	79/77	-	-	-
		Cooling	50/50	53/50	59/56	68/67	-	-	-
Sound Pressure (Measured at 1.5m under level the center of the unit)	dB(A)	36/38	34/36.5	26.5/29	19/21	37/39	35/37.5	27/30	18.5/20
Weight	Pounds	132							
Starting current		5.0A							
Filter Specification		Standard Filter Provided (MERV 6)							

Model		TLGHF12001RX501A					
Power source		208/230V, 1-phase, 60Hz					
Ventilation mode		Lossnay ventilation			Bypass ventilation		
Speed		Extra high	High	Low	Extra high	High	Low
Current	A	5.7/5.8	5.0/5.3	3.1/3.4	5.8/5.8	5.1/5.4	3.1/3.4
Input	W	1185/1303	1040/1219	639/765	1185/1303	1040/1219	639/765
Air volume	CFM	1200/1200	1012/1200	695/824	1200/1200	1012/1200	695/824
External static pressure	In. W.G.	0.43/0.75	0.43/0.43	0.20/0.20	0.43/0.75	0.43/0.43	0.20/0.20
Temperature recovery efficiency (%)		67/67	68/67	75/73			
Enthalpy recovery efficiency (%)		Heating	64/64	65/64	71/68		
		Cooling	50/50	53/50	59/56		
Sound Pressure (Measured at 1.5m under level the center of the unit)	dB(A)	38/40.5	36/39	29/32	40/42.5	38/41	30.5/33.5
Weight	Pounds	265					
Starting current		10.0A					
Filter Specification		Standard Filter Provided (MERV 6)					

Specifications are subject to change without notice.

LIMITED WARRANTY | Seven-year compressor and one year parts. Extended warranty of up to 10 years is available. See our website for details on specific additional application installation coverage.

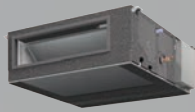

SPECIFICATIONS: DEDICATED
OUTDOOR AIR SYSTEMS

TPEFYP-AF

Model Name			TPEFYP120AF140A	TPEFYP120AR140A
Power Source			208/230V, 1 Phase, 60Hz	
Cooling Capacity	BTUH *1		112,000	112,000
Heating Capacity	BTUH *1		61,400	61,400
Reheat Capacity	BTUH		-	24,200
Power Consumption	Cooling	W	660/780	
	Heating	W	660/780	
Current	Cooling	A	3.19/3.45	
	Heating	A	3.19/3.45	
External Finish			Galvanized	
Dimensions	Height	In.	18-9/16	
	Width	In.	49-1/4	
	Depth	In.	55-1/8	
Net Weight	Unit	Pounds	287	309
Heat Exchanger			Cross Fin (Aluminum Plate Fin and Copper Tube)	
Fan	Type x quantity		Sirocco Fan x 2	
	Airflow Rate *2	CFM	1,200	
	External Static Pressure	In. WG	0.40-0.60-0.88 (208V)	0.28-0.48-0.80 (208V)
			0.64-0.80-1.04 (230V)	0.52-0.72-0.96 (230V)
Motor Type		Single-phase Induction Motor		
Air Filter			Field Supply	
Main Coil Refrigerant Pipe Dimensions	Liquid (High Pressure) (Flare)	In.	3/8	
	Gas (Low Pressure) (Flare)	In.	7/8	
Reheat Coil Refrigerant Pipe Dimensions	Liquid (High Pressure) (Flare)	In.	-	7/8
	Gas (Low Pressure) (Flare)	In.	-	3/8
Drain Pipe Dimension (O.D.)		In.	1-1/4 x 2	
Sound Pressure Level *3	Low-Mid-High	dB(A)	36-38-41 (208V)	
			39-41-43 (230V)	
Operating Temperature Range	Cooling		50° F WB to 95° F WB (109° F DB) (10° C WB to 35° C WB [43° C DB])	
	Heating		-4° F WB to +60° F WB (-20° C WB to +15.5° C WB)	
Connectable Outdoor Unit			TUHYP120TLMUA(-BS), TUHYP120YLMUA(-BS) TUHYP120TKMUA(-BS), TUHYP120YKMUA(-BS)	TURYP120TLMUA(-BS), TURYP120YLMUA(-BS) TURYP120TKMUA(-BS), TURYP120YKMUA(-BS)

NOTES:

*1 Cooling/Heating Capacity indicates the maximum value at operation under the following conditions:

Cooling | Entering Indoor Unit: 87° F (31° C) D.B./80° F (27° C) W.B.

Cooling | Outdoor Unit: 87° F (31° C) D.B.

Heating | Entering Indoor Unit: 32° F (0° C) D.B.

Heating | Outdoor Unit: 32° F (0° C) D.B./28° F (-2° C) W.B.

Ventilation Air: Providing sufficient ventilation air is an important part of very building design ASHRAE Standard 62 provides the minimum air requirements. Also check local codes.

Specifications are subject to change without notice.

LIMITED WARRANTY | Seven-year compressor and one year parts. Extended warranty of up to 10 years is available. See our website for details on specific additional application installation coverage.



TPEFYP*OA140A**

Model Name			TPEFYP036OA140A	TPEFYP048OA140A	TPEFYP072OA140A	TPEFYP096OA140A
Power Source			208/230V, 1-Phase, 60Hz			
Cooling Capacity		BTUH *1	36,000	48,000	72,000	96,000
Heating Capacity		BTUH *1	21,000	28,000	43,000	57,000
Power Consumption	Cooling	kW	0.130	0.180	0.220	0.320
	Heating	kW	0.140	0.200	0.240	0.330
Current	Cooling	A	1.25	1.59	1.86	2.56
	Heating	A	1.09	1.46	1.70	2.42
Temperature Range	Cooling *2	°F	63~118°F D.B.			
	Heating *3	°F	14~59°F D.B.			
External Finish			Galvanized steel sheet			
Dimensions	Height	In.	15	15	18-9/16	18-9/16
	Width	In.	47-1/16	47-1/16	49-1/4	49-1/4
	Depth	In.	35-7/16	35-7/16	44-1/8	44-1/8
Net Weight	Unit	Pounds	109	109	177	177
Heat Exchanger			Cross fin (Aluminum fin and copper tube)			
Fan	Type x Quantity		Sirocco fan x 1	Sirocco fan x 1	Sirocco fan x 2	Sirocco fan x 2
	Airflow Rate *4	CFM	350 - 400 - 450	500 - 550 - 600	700 - 800 - 900	1,000 - 1,100 - 1,200
	Motor Type		DC Motor			
	Motor Output	kW	0.244	0.244	0.375	0.375
Air Filter			Field Supply			
Refrigerant Pipe Dimensions	Liquid (High Pressure) (Braze)	In.	3/8			
	Gas (Low Pressure) (Braze)	In.	5/8	5/8	3/4	7/8
Drain Pipe Dimension (O.D.)		In.	O.D. 1-1/4 x2			
Sound Pressure Levels (As Measured in an Anechoic Room)*3	Low-Mid-High	dB(A)	35-38-40	38-40-41	34-38-42	39-41-44

NOTES

- Capacity indicates the maximum value at operation under the following condition.
Cooling: Indoor 91°F (32.7°C)DB/82°F (27.8°C)WB, Outdoor 91°F (32.7°C)DB.
The set temperature of the remote controller is 63°F (17.2°C).
Heating: Indoor 32°F (0°C)DB/27°F (-2.9°C)WB, Outdoor 32°F (0°C)DB/27°F (-2.9°C)WB.
The set temperature of the remote controller is 77°F (25°C).
 - Thermo-off (FAN-mode) automatically starts if the outdoor temperature is lower than 63°F (17.2°C)D.B.
The fan speed automatic runs at a very low speed if the outdoor temperature is greater than 109°F (42.8°C)D.B.
 - Thermo-off (FAN-mode) automatically starts if the outdoor temperature is higher than 59°F (15.0°C)D.B.
 - If the airflow rate is over the usable range, dew drops can be caused from the air outlet and the airflow rate is changed automatically because of the output down by the fan motor control. If the air flow rate is less than the usable range, condensation from the unit surface may occur.
- The maximum connectable indoor units to 1 outdoor unit are 110% (100% in case of heating below 23°F (-5°C)).
 - When fresh air intake type indoor units connect to an outdoor unit together with other types of indoor unit, the total capacity of fresh air intake type indoor units needs to be 30% or less of the connected outdoor unit capacity.
 - Un-conditioned outdoor air such as humid air or cold air blows to the indoor during thermo off operation.

Please be careful when positioning indoor unit air outlet grilles, ie take the necessary precautions for cold air, and also insulate rooms for dew condensation prevention as required.

- Fresh air intake type indoor units cannot be connected to TUMY and cannot be connected to an outdoor unit together with TPWFYF series.
- See data book and technical service manual for more details and system restrictions.



© 2019 Mitsubishi Electric Trane HVAC US. All rights reserved.

Mitsubishi Electric, Lossnay, and the three-diamond logo are trademarks of Mitsubishi Electric Corporation. CITY MULTI, kumo cloud and H2i are registered trademarks of Mitsubishi Electric US, Inc. Trane is a registered trademark of Ingersoll-Rand plc. All other product names mentioned herein are trademarks or registered trademarks of their respective owners.

ENERGY STAR and the ENERGY STAR mark are registered trademarks owned by the United States Environmental Protection Agency.

Use of the AHRI Certified™ mark indicates a manufacturer's participation in the certification program. For verification of certification for individual products, go to www.ahridirectory.org.

Specifications shown in this brochure are subject to change without notice. See complete warranty for terms, conditions and limitations. A copy is available from Mitsubishi Electric Trane HVAC US LLC.

SKU: ME-50-CMVRF | 10.2019 | Printed in the USA



For more information visit
Visit trane.com/ductless



Please recycle.