

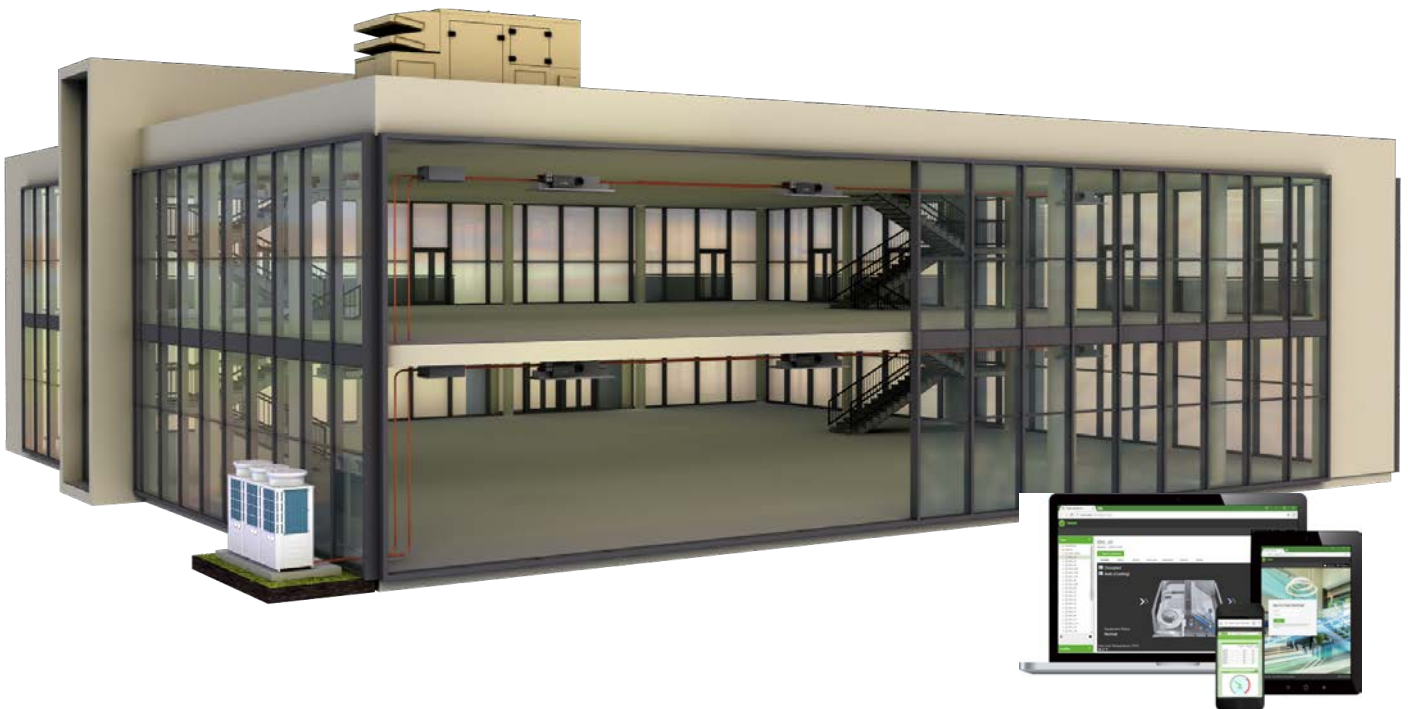

# System Catalog

Variable Refrigerant Flow Systems

An engineered system from Trane



APP-PRC007C-EN  
April 2022

# Trane® Variable Refrigerant Flow Systems

VRF System Overview  
page 3

System Decision Wheel  
page 4

System Components  
page 5

Indoor Units  
page 8

Operating Modes  
page 12

System Considerations  
page 14

Application  
Considerations  
page 16

Humidity Control  
page 24

Psychrometric Analyses  
page 30

Ventilation System  
page 38

System Control  
page 48

Energy Analysis  
page 56

Design Resources  
page 67

LEV Kit Selection  
page 70

Additional VRF  
Resources  
page 71

## Comprehensive solution with built-in expertise

Trane is uniquely positioned to offer a comprehensive variable refrigerant flow (VRF) system solution that engineers, contractors, and business owners can rely on now and for years to come. Through a joint venture, Mitsubishi Electric Trane HVAC US (METUS), Trane provides best-in-class VRF and ductless technology that is backed by the building expertise, support and service. Because Trane provides all product components in the VRF system, customers receive the best solution for each project—backed by a vast network of pre- and post-sales, engineering and support resources that are among the most accessible in the industry.

Once installed, Trane offers factory startup performed by a factory-trained technician, not a third-party representative. When systems are up and running, Trane can partner with you to provide service and maintenance, as needed, over time.

## What this means for customers

- System designs that meet the specifications and performance expectations of your commercial project
- Proper equipment sizing and selection
- Worry-free installation, set up and integration
- Ongoing service and support

Whether you are an engineer preparing a specification, a contractor seeking to find the right equipment to install, or a facility manager or business owner seeking top performing solutions, Trane offers support from teams dedicated to providing best-in-class solutions for our customers.

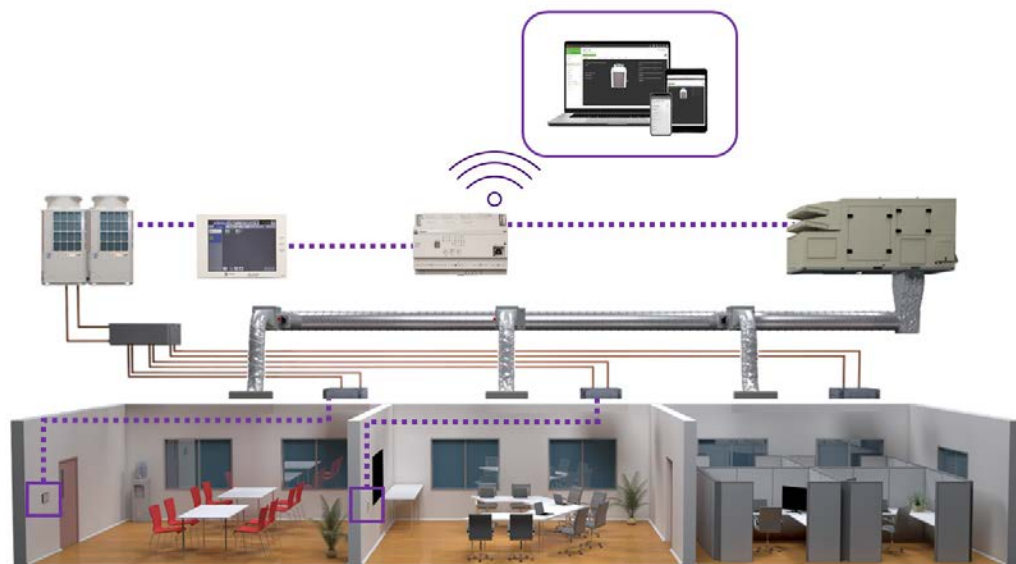

For more information, go to [www.trane.com/VRF](http://www.trane.com/VRF) to find the latest brochures, catalogs, and materials.

# VRF System Overview

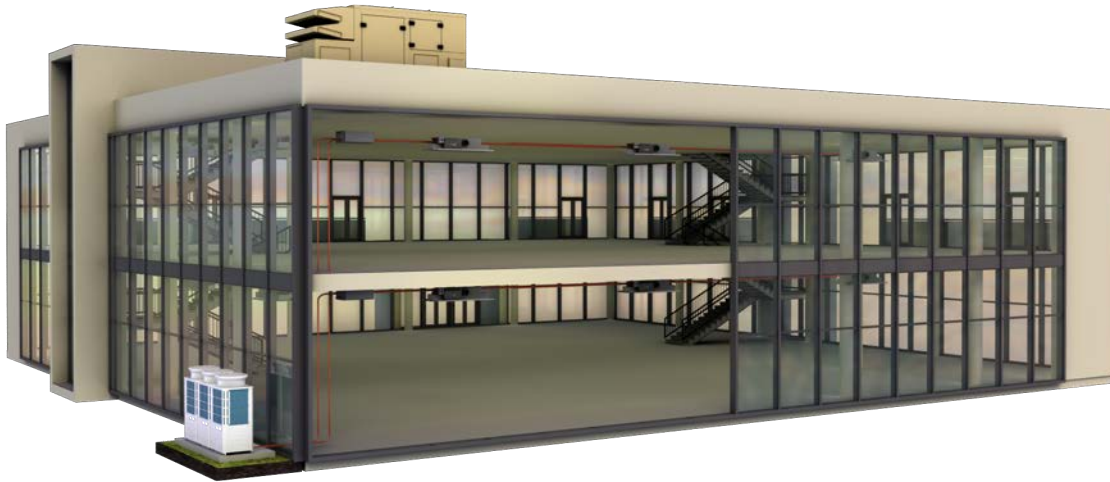

VRF is a popular choice for a variety of buildings because it can offer high energy efficiency, smaller footprints, and system flexibility. Additionally, VRF heat pumps and heat-recovery systems are popular strategic electrification solutions as part of the drive to decarbonize HVAC systems.

In a typical VRF system, each zone has one or more indoor units, which provide cooling and heating to maintain the desired zone temperature. As a result, a VRF system is considered a distributed HVAC system with cooling and heating equipment dispersed throughout the building.

These systems include the entire VRF system (terminal units, branch controllers, condensing units, and interconnecting piping), the ventilation systems, as well as the controls to ensure proper operation.

## Controls

The VRF system will have dedicated controls to coordinate all of the functions of the system. The VRF controls include wall-mounted controllers, indoor unit controllers, branch controllers, outdoor unit controllers and (optionally) a central controller. These individual controls are connected by a dedicated communication network.

The building may also have a building automation system (BAS) to coordinate the VRF and ventilation systems, as well as other systems in the building such as lighting, exhaust fans, and other HVAC systems in other parts of the building. A BAS can enhance a standard VRF control system by providing additional functionality for complete building control, monitoring, data collection, and remote access.

## Ventilation Systems

Typically, outdoor air required for ventilation is conditioned and delivered by a separate ventilation system. Most codes and standards require ventilation air be supplied to the occupied zones to ensure adequate indoor air quality and occupant satisfaction. A VRF system may employ a separate outdoor air system to condition and supply the code- or standard-required ventilation to each zone.

At a minimum, the ventilation system provides the outdoor air required for the spaces served. These systems can be designed to passively or actively condition the outdoor air before entering the building. When actively conditioning the outdoor air, the ventilation system can be designed to offset the outdoor air load or offset the outdoor air load and some, or all, of the space load.

# VRF System Decision Wheel

VRF system design does not need to be complicated. With just a few considerations, decisions can be made to ensure a successful system. These critical decisions can be visualized with the Decision Wheel shown below. This systems catalog will use the Decision Wheel as a guide to detail design considerations for a VRF system.

## System Type:

### *Heat Pump or Heat Recovery?*

One of the largest benefits of a VRF system is that the indoor units utilize coils which can heat or cool the zones. Heat pump system configurations can either completely cool or completely heat all the zones served. In a Heat Recovery system each individual zone can either heat or cool as needed. When simultaneously cooling and heating in a heat recovery system, energy can be transferred from one space to condition another.

## Humidity Control:

### *To what level will you manage humidity in your building?*

Humidity management is an often-overlooked decision. In many system designs, the ventilation equipment is sized to simply treat the outdoor air to a space neutral dew-point temperature at design. This would be an example of outdoor air treatment only. However, careful selection of both the terminal system at design- and part-load operation, as well as ventilation systems are necessary if space humidity is a concern.

## Ventilation System:

### *How will ventilation air be conditioned—energy recovery ventilator or dedicated outdoor air system?*

At a minimum, a filter and fan setup is required to supply ventilation air to a building. Many building energy codes also require exhaust-air energy recovery. As a result, a basic ventilation system might consist of an energy recovery ventilator (ERV). For additional air treatment—including humidity control—a dedicated outdoor air system (DOAS) would likely be required.

## System Control:

### *How will the system be controlled?*

Controls are necessary to operate the VRF and ventilation systems. In some applications, it might be acceptable to rely on the dedicated VRF control system to operate **Independent** of other systems in the building. In other cases, the control of the VRF system may need to be coordinated with other systems in the building, requiring an **Integrated** control system or BAS. See page 48 for a discussion of VRF control options.

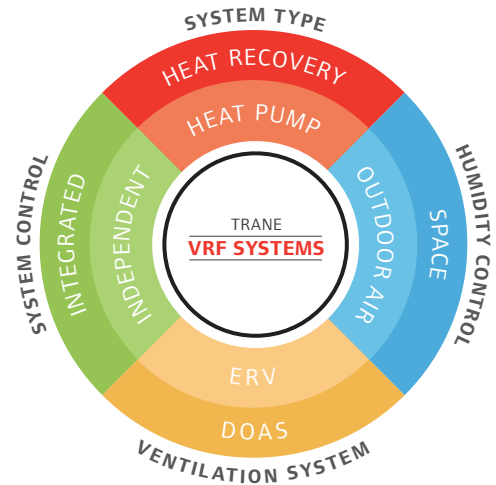

# VRF System Components

VRF is available as heat pump and heat recovery. It's common to see both **heat recovery** and **heat pump** systems on the same building, but their application is fundamentally different.

VRF systems might include many of the following components:

- Air and water-source VRF condensing units
- Ductless and ducted indoor units
- Linear Expansion Valve (LEV) kit  
(for use with Trane air-handling equipment)
- Outdoor Air Processing (OAP) units
- Refrigerant-to-water heat exchangers
- Branch controllers (for heat recovery systems)

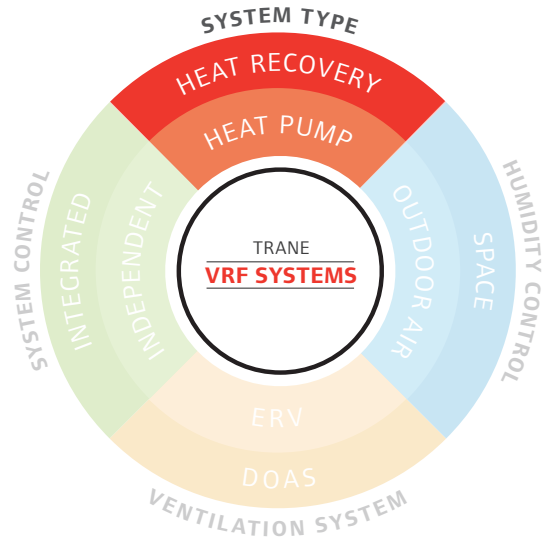

## VRF Condensing Units

VRF is a direct expansion (DX), multiple zone HVAC system. Using distributed DX piping, multiple indoor fan coils are connected to a single VRF condenser. These systems use linear expansion devices coupled with variable-speed condenser fans and variable-speed compressor technology to achieve high efficiency. VRF condensing units are available as air-source or water-source heat rejection.

Heat pump units are only capable of providing cooling or heating, exclusively. Because of this, zones served should have similar load variations and occupant requirements for heating and cooling. This avoids the risk of one zone needing heat while other zones require cooling (or vice versa). As a result, heat pump VRF should only be used in applications with zones that experience uniform load profiles or cooling-only applications.

Heat recovery provides the ability to provide simultaneous heating and cooling without regard to the system operation, or individual tenant demands. This is accomplished without the use of reheat. Heat recovery systems should always be used for applications with dissimilar or divergent temperature zones.



## Air-Source VRF Condensing Unit

Air-source VRF condensing units use a refrigerant-to-air heat exchanger, which allows the system to exchange heat with the ambient air. Trane® / Mitsubishi Electric offers several models:

- Smart Multi™ heat pump with optional low ambient hyper-heating.
- Y-series heat pump TUHY with optional low ambient hyper-heating.
- R2-Series heat recovery TURY with optional low ambient hyper-heating.



There are two styles of air-source VRF (AS-VRF) condensing units. Smaller units have a horizontal condenser fan, and are only available with 208-1-60 volt or single-phase electricity. For this reason, it is called “single-phase VRF” or just “single-phase.” This product is heat pump only, and limited from 3 to 5 tons.

Systems 6-tons and larger are commonly called “VRF.” These units use a vertical discharge fan, and are only available in three-phase electricity. Common voltages are 208/230-3-60 and 460-3-60. Larger tonnage systems can be created by combining up to three modules. When combining modules to create a larger system, Diamond System Builder® will size refrigerant piping for the installed combination. Per U.S. Department of Energy regulations, only discrete AHRI-tested and approved multiple module combinations are allowed.

### Cooling-only VRF

In North America, VRF is only offered as heat pump or heat recovery. There are many applications, which do not require heat pump units may be locked to “cooling only” to prevent unintentional activation of the heating function.

### Single-phase VRF energy ratings

Single-phase VRF falls under the Department of Energy’s residential guidelines. Unlike larger VRF which are rated with EER and IEER, this product is rated using SEER and HSPF energy ratings.

## Water-Source VRF Condensing Unit

Water-source VRF condensing units use a water-to-refrigerant heat exchanger. This allows the system to utilize water loops connected to devices, such as cooling towers, dry coolers, and boilers. One advantage for water-source VRF condensing units is their use in colder climatic conditions. As the units are installed indoors, maintenance staff, and workspaces are protected from the elements. During heating season the heat pump heats the space and cools a ground-source water loop. During peak winter hours a boiler may be used to supplement additional required heat. This effectively decouples the system from the outdoor conditions, and provides consistent heat performance.

The use of a water loop also permits ground coupling VRF and allows heat to be stored within the earth (see Ground-source VRF, page 21). For this reason water-source VRF is well suited for densely built municipalities where air-source equipment is not desired, equipment footprint is limited, or not allowed by local code. Trane® / Mitsubishi Electric offers several models:

- WY-series heat pump TQHY
- WR2-Series heat recovery TQRY



### Water-source VRF and brazed plate heat exchangers

Water-source VRF systems use stainless steel brazed plate heat exchangers which have tight tolerances. All municipal water supplies contain sediment that will eventually lodge in the heat exchanger, restricting water flow. As flow is reduced, there is risk of the water freezing and bursting the heat exchanger. The resulting water-contaminated refrigerant is destructive to the water-source system. To prevent this scenario, a simple solution is to use both 50 mesh or better washable strainers, and flow proving devices with all water-source VRF condensing systems.

### Water-source VRF and “double heat recovery”

Water-source units benefit from double heat recovery, which allows heat to be transferred between zones served on a single heat recovery VRF system and between multiple heat recovery condensing units connected by a single closed water loop.

Water-source condensing units do not require condensing fans as heat is rejected to the water loop. This reduces their footprint, and allows for installation in opportunistic spaces such as converted janitors closets. This also allows decentralization of the condensers, placing them closer to the indoor fan coil units. If ASHRAE® Standard 15 refrigerant concentration limits requirements are a concern, decentralized water-source units may provide an opportunity to reduce the refrigerant charge.

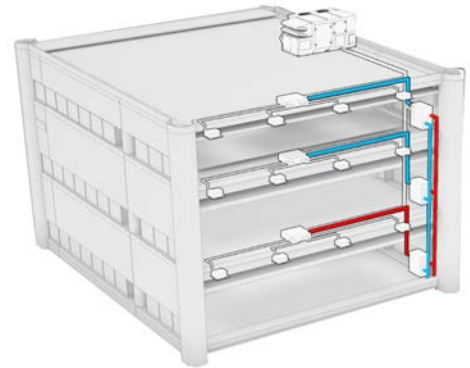

Water-source VRF condensing units are typically small enough to fit into elevators, enabling easier installation in basements, penthouses, or on individual floors. It may be possible to reuse existing boilers, cooling towers, and other hydronic components.

### Single-phase VRF versus mini-splits

Mini-split units are another ductless system that is commonly confused with VRF. This is due to the visual similarity of the condensing cabinets and indoor fan coils. Adding to the confusion, some mini-splits are capable of connecting to multiple indoor fan coil units.

Mini-splits do not use a distributed DX piping arrangement. Instead, the refrigerant lines, power source, and control wiring must “home run” directly back to the mini-split condensing unit, or a mini-split piping branch box. Further, the expansion device is located within the condensing unit, or a special manifold device. For this reason, there is only one approved refrigerant line-set per product size, and the maximum piping length is much shorter than similar VRF products.

Mini-splits are found in capacities from 0.5 to 5 tons. With high efficiencies, these units are useful for addressing smaller loads such as IT closets or other after-hour applications.

#### What's in a name?

The air-source condensing units are sometimes abbreviated as ODU, or “outdoor units.” This is to differentiate them on mechanical schedules from the “indoor” fan coils. However, water-source condensing units are designed for indoor installation. As air-source units are more common, it is common industry “slang” to refer to all VRF condensing units as outdoor units.

# Trane® / Mitsubishi Electric Indoor Units

Traditional split systems components include one heat pump condensing unit connected to one indoor air handler. VRF systems use multiple indoor units connected with one condensing unit. Single-phase systems may have as many as 12 indoor units connected to one condensing unit, and three-phase VRF may have as many as 50 indoor units connected to a single condensing unit.

VRF indoor units are available in two categories; ductless, and ducted. Ductless products include high wall units, cassettes, ceiling suspended units, and floor standing units. Ducted products include low, medium, and high static ducted fan coils, multi-position residential size air handlers, and LEV-kits combined with traditional built up air handlers.

## Ductless Indoor Units

### High-Wall Unit (0.5 to 2.5 tons)

TPKFY high wall units are mounted horizontally six feet or higher on a vertical surface. Supply air is discharged from the bottom, and returns to the top. To prevent air flow “bounce back” and short cycling, high wall units generally work better where there are no obstructions within ten feet. It is important to consult the installation guidelines, as installing “too high” may decrease performance. High walls are often used in multi-family, lobbies, and historical retrofits.



### Recessed Ceiling Cassette (0.75 to 4 tons)

TTPLFY recessed ceiling cassette units are also commonly called ceiling cassettes. These units are installed flush with the horizontal drop or finished ceiling surface, but are also used with exposed ceiling plans. Conditioned air is provided in up to four directions with a central return. The cassette chassis are field-convertible from four to as few as two discharges. The cassette discharge opening should be a minimum of five feet from vertical obstructions to prevent “dumping” airflow down a wall, along with drafts and moisture condensation. To promote uniform heating performance, the height of cassettes is generally limited to ten feet above the finished floor. Avoid installing cassettes too close to other cassettes, as this may lead to temperature conflict. These units are often used in office spaces, lobbies, classrooms, and conference rooms.



### Recessed One-Way Ceiling Cassette (0.5 to 1.25 tons)

TPMFY one-way ceiling cassettes are similar to a ceiling recessed unit, but are designed with a single supply air discharge. This unit is installed flush with horizontal or finished ceiling surfaces, and work best when installed offset to the side of a room. For best performance care must be taken to space the return of the unit no closer than three feet from any vertical surfaces. To prevent “dumping” airflow, the supply air should not be closer than five feet from a vertical obstruction. Care should be taken to avoid installing too close to other cassettes, which may lead to poor performance and temperature conflict. These units are often used in hallways, open office spaces, lobbies, classrooms, and conference rooms.





### Ceiling Suspended Units (1.25 to 3 tons)

TPCFY ceiling suspended units are mounted below horizontal hard surfaces that prevent installation of ceiling cassettes. For best performance, care must be taken to ensure adequate space for return air. Ceiling suspended units are commonly found in casinos, restaurants, open spaces, or oriented down long narrow spaces. These units generally work better where there are no obstructions within ten feet to the face of the unit.



### Floor-Mounted Units (0.5 to 2 tons)

TPFFY floor mounted or floor-standing units resemble traditional fan coil or cabinet heater style HVAC systems. These units are available as exposed or recessed styles with a top discharge. The bottom return cannot be obstructed. Common installations are classrooms, office space, corridors, and lobbies.



## Ducted Indoor Units

### Low Static Ducted Units (0.5 to 2 tons)

TPEFY low static ducted units are horizontal units that are easily concealed, but may also be exposed. These units sacrifice performance for a low profile construction and have short duct runs from three to six feet, with minimal filtration. These units may not have the static pressure capability to support an external filter rack. Common installations are hotel rooms installed over the bathroom, small office spaces, and exposed spot cooling without ductwork.



### Medium Static Ducted Units (0.5 to 4.5 tons)

TPEFY medium static ducted units are horizontal units that may be installed concealed or exposed. These units support external filter racks with MERV-rated filters, and the associated supply and return ductwork. Common installations include office spaces, classrooms, hotels, and assisted living facilities.



### High Static Ducted Units (1.25 to 8 tons)

High static ducted units are horizontal units that may be installed concealed or exposed. These units are the largest standard capacity VRF fan coils. They require external filter racks, with MERV rated filters. The high static pressure of these units is beneficial when using distributed supply and return ductwork serving multiple spaces. Common installations include office spaces, classrooms, and small auditoriums.

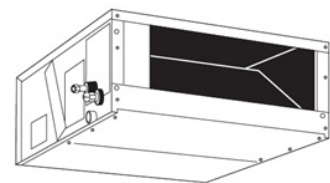

### Multi-Position Air-Handler (1 to 4.5 tons)

TPVFY multi-position air handlers resemble residential style air handlers.

These units may include electric resistance heaters. Installation options include up-flow, horizontal left, horizontal right, or down-flow configurations. Downflow installations may require a condensate management kit. Multi-position units are installed with ducted supply and return, and it is possible to "twin" units to serve larger zones. Ideal applications include residential, multi-tenant, hotels and attic installations.



## Additional Components

### Linear Expansion Valve (LEV) Kit

VRF systems are capable of integrating built up air handlers using LEV kit assemblies. This allows for higher airflows, higher static pressure, larger capacity, customized products, and DOAS configurations.

The kit is available in multiple tonnage sizes, and requires three components, a LEV, a LEV control box, and a LEV-kit rated heat pump coil. If larger capacities are required, the designer may combine multiple LEV kits and condensing units with a single air-handling unit. Using these kits allows installation of an air handling unit to be as far as 541 actual feet (623 equivalent feet) from the condensing unit.

When using LEV kit-equipped air handlers serving a high percentage of outside air, it is best to pair the system with a dedicated VRF heat pump condensing unit. If the outdoor air application requires a VRF heat recovery system, please consult the VRF LEV Kit Split System Selection Guide (VRF-APG003-EN).



### Outdoor Air Processing (OAP) units

The TPEFY-OA fan coil is designed for 100 percent outdoor air. It is often referred to as an “outdoor air processing (OAP) unit” or an “outdoor air unit (OAU).” Although OAP units function as a split DOAS, they are designed for simple projects that do not require large tonnages, or temperature and control flexibility. These units are also useful as they integrate with other indoor units using the same City Multi® M-Net controls system, and provide the owner with a simplified BAS system. They are best suited for tempering applications where precise temperature control and space humidity management is not a priority.



### Lossnay Energy Recovery Ventilator

The Lossnay energy-recovery ventilator (ERV) unit is available in six sizes from 300 to 1200 CFM. These units are ideal for smaller projects that don't require tight humidity control. These units may be used as standalone or interfaced with the native VRF controls.



### Heat Exchangers

TPWFY hex units are refrigerant-to-water heat exchangers available in two styles. The first is a hot-water, heating only unit with temperatures as high as 160°F. The second is an auxiliary unit that may produce either chilled water down to 41°F or hot water as warm as 131°F. Heat is exchanged to a chilled- or hot-water loop for use by other processes. Additional hydronic specialties such as pumps, storage tanks, and a 50-mesh or better washable strainer are required. Example applications include radiant floor heating, chilled/hot water air-handlers.



### Branch Controllers

All heat recovery control systems require a City Multi® Branch Controller®. It is connected between the outdoor unit and multiple indoor units, and is the intermediate heat transfer device that enables simultaneous heating and cooling. This device houses a series of diverting valves, gas/liquid separators, and subcoolers that distribute high or low-pressure refrigerant as needed between the indoor units. As the branch controller manages the refrigerant phase change, the need for a dedicated third suction line to the outdoor unit is eliminated.

Branch controllers may consist of a single device, or a main branch controller with up to ten sub-branch controllers. Use of sub-branch controllers allow decentralizing the location of components due to building architecture. Sub-branch controllers also expand the number of indoor units that may be used on a single system, and allow as many as 50 indoor units on a single system. When using a sub-branch controller, two pipes are used between the condensing unit and the main branch controller, and three pipes are required between the branch controller and the sub-branch controllers.

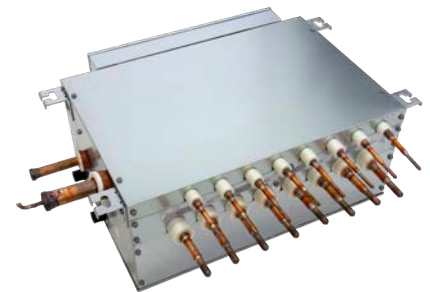

# VRF Operating Modes

Heat pump systems can operate in two distinct modes—cooling or heating—to maintain zone comfort. Heat pump systems cannot provide simultaneous heating and cooling. Heat recovery systems operate in four modes—cooling, cooling main, heating, and heating main—to provide simultaneous cooling and heating to those zones that need it.

## Cooling Only Mode

When a heat pump system is in cooling only mode, all active indoor units are calling for cooling. The heat pump condensing unit delivers subcooled liquid refrigerant to the linear expansion devices. After passing through the expansion devices, the liquid is evaporated as heat is absorbed within the indoor coil, and undergoes phase change to a superheated gas. The superheated gas must be returned to the heat pump condensing unit accumulator to repeat the cycle.

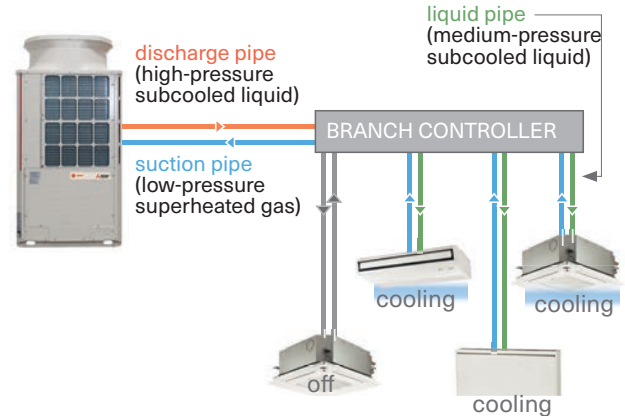

When a heat recovery system is in cooling only mode, all active indoor units are calling for cooling. The heat recovery condensing unit delivers subcooled liquid refrigerant to the branch controller. The branch controller provides additional subcooling and distributes the liquid to the linear expansion devices. After passing through the expansion devices, the liquid is evaporated as heat is absorbed by the refrigerant within the indoor coil and undergoes phase change to a superheated gas. The superheated gas must return to the heat recovery condensing unit accumulator through the branch controller to repeat the cycle.

## Cooling Main Mode

When a heat recovery system is in cooling main mode, the majority of indoor units by capacity are calling for cooling, with an active minority of indoor units requiring heat. The heat recovery condensing unit delivers a high pressure liquid/gas refrigerant mixture to a branch controller. The branch controller separates the hot gas and liquid refrigerant using a gas liquid separator. Hot gas is sent to the units calling for heating allowing heat to be “rejected” to the space and providing additional subcooling to the liquid refrigerant from the gas liquid separator. Subcooled liquid is then returned to the branch controller where it is mixed with subcooled liquid at the gas liquid separator. It is then provided to indoor units calling for cooling where it is evaporated as refrigerant absorbs space heat within the indoor coil and undergoes phase change to a superheated gas. The superheated gas is returned to the branch controller and mixed with subcooled liquid from the heating coils. The resultant two-phase mixture is returned to the heat recovery condensing unit accumulator to repeat the cycle.

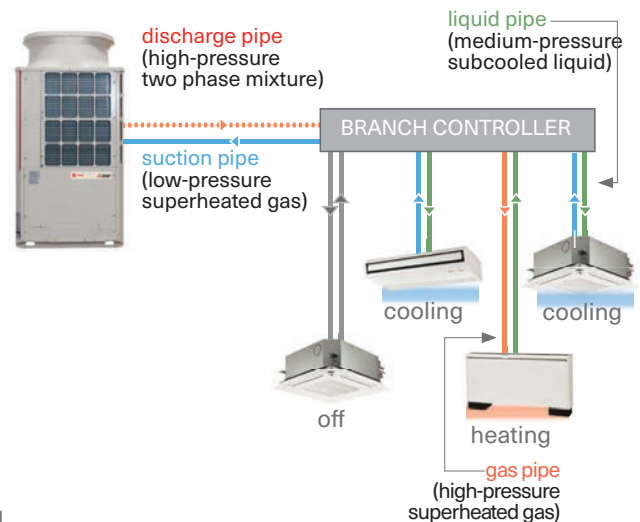

## Heating Main Mode

When a heat recovery system is in heating main mode, the majority of indoor units by capacity are calling for heating, and with an active minority of indoor units also calling for cooling. The heat recovery condenser unit delivers a high-pressure two-phase hot gas to a branch controller. The branch controller separates the hot gas and liquid refrigerant using a gas liquid separator. Hot gas is sent to the units calling for heating allowing heat to be “rejected” to the space and it is condensed to a liquid and subcooled. This liquid then returns to the branch controller where it provides additional subcooling to the liquid from the gas liquid separator. This liquid is provided to indoor units calling for cool where it is evaporated as refrigerant absorbs space heat. The resulting low pressure superheated gas returns to the branch controller and is mixed with excess subcooled liquid from the heating coils. The resultant two-phase mixture is returned to the heat recovery condensing unit accumulator to repeat the cycle.

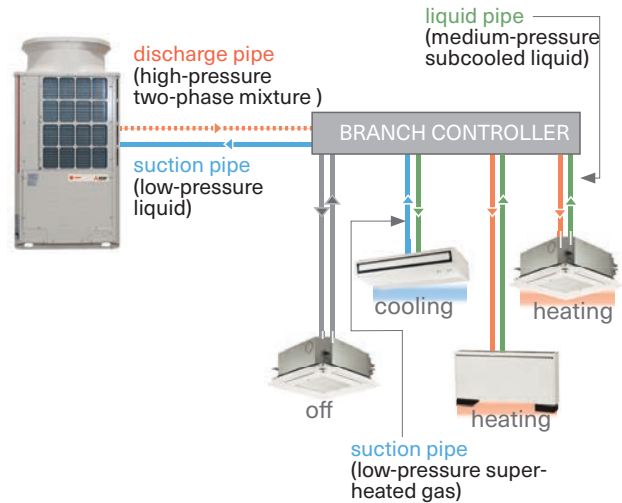

## Heating Only Mode

When a heat pump system is in heating mode, all active indoor units are calling for heating. The heat pump condensing unit delivers a superheated high pressure hot gas to the indoor units allowing heat to be “rejected” to the space. Hot gas passes through the indoor coil and is condensed to a subcooled liquid. This liquid is sent to the heat pump condensing unit accumulator, to repeat the cycle.

When a heat recovery system is in heating only mode, all active indoor units are calling for heat. The heat recovery condensing unit delivers a superheated high pressure hot gas to a branch controller. Hot gas is then sent to the units calling for heating allowing heat to be “rejected” to the space and it is condensed to a subcooled liquid. This subcooled liquid returns to the branch controller where it passes to the heat recovery condensing accumulator unit to repeat the cycle.

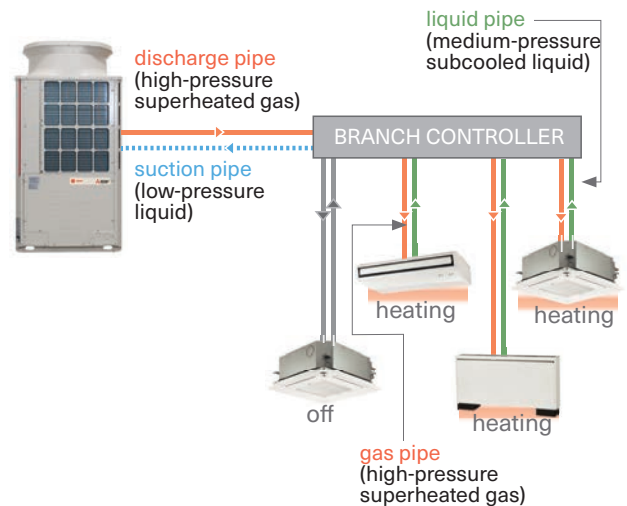

# System Considerations

## Heat Recovery

Using the four previously described sequences, the heat recovery unit is able to simultaneously heat and cool multiple zones without reheat, and independent of the operation of other indoor units. Branch controllers are required for heat recovery systems, and enable the transfer of energy between zones connected to it. If the controller is connected to one or more sub-branch controllers, then the exchange of energy also occurs between the connected controllers.

As the building loads shift from cooling-dominant to heating-dominant or vice versa, the heat recovery condensing unit shifts operation accordingly. This allows the system to provide a high degree of individual comfort. If an application has multiple divergent zones, the application requires a heat recovery system.

## Heat Pump

Heat pump systems are designed for to serve homogeneous temperature zones. Branch controllers are not used with heat pump systems which limits these condensers to either cooling-only mode, or heating-only mode. (For designers who intend to use heat pumps on divergent or mixed mode operation please see side bar Heat Pump “Trap”).

## Scheduled Changeover

The easiest heat pump changeover strategy is to set the mode of operation based on a time-of-day schedule. The winter, and summer months are simple, and are set to heating, and cooling respectively. Setting the schedule for shoulder

seasons can pose a challenge. During shoulder seasons, it is common to require heat in the morning, and cooling in the afternoon. The space becomes extremely uncomfortable if the mode is not manually overridden. This strategy is strongly discouraged.

## Averaging/Voting Changeover

With an averaging changeover, the system polls the indoor units to determine the deviation from space temperature versus setpoint. A heat or cool mode is set based on this calculation. An alternative approach is to use a voting method in which the VRF system satisfies the majority demand before shifting to the minority. Both of these strategies often result in large temperature swings resulting in improperly conditioned zones. Additional concerns are the averaging and voting systems do not address the users individual needs. These strategies should not be applied to individual zones that require user-commanded heating and cooling such as dormitories, auditoriums, banquet halls, hotels, nursing homes, corner offices or information technology spaces. Instead these zones should be moved to their own systems, or the designer should consider using heat recovery.

## Representative Group Changeover

It is possible to set an individual indoor unit as mode master, and the remaining indoor units are set as mode followers. The mode master and followers are grouped into similar representative zones, and each group is served by its own condensing unit. When the mode leader requires changeover, it directs the mode followers to change their operation. The mode followers units will not changeover on

### Heat Pump “Trap”

It may be tempting to reduce first costs by using a heat pump system instead of heat recovery. Heat recovery systems provide zone-specific air conditioning. Heat pump systems can only operate in a single mode at a single time. There are several options to specify how heat pump systems change modes. Regardless of the approach, experience shows using heat pumps in lieu of heat recovery results in low tenant satisfaction.

### Mixed Systems

It is very common for designers to use heat pump units and heat recovery systems for the same project. Schools are a common example. When designing the school, the library, cafeteria, lobby, corridors and auditoriums each have a dedicated heat pump. However, the classrooms, offices, and workspaces often require simultaneous heating and cooling.

their own, so it's critical that tenants can easily locate the mode leader controller. It's also possible to control multiple indoor units with a single controller. This simpler approach reduces confusion regarding which unit is the "mode leader." Review with the product manufacturer during design, as not all manufacturers support this functionality.

This approach should not be applied to multiple zones with divergent thermal loads as it can create conflict between tenants. For this reason, it should never be applied to dormitories, hotels, nursing homes, individual offices, or individual zones that require user-commanded heating and cooling. Designers should consider serving these zones with heat recovery.

## Outdoor Air Changeover

It is possible to change the mode of the system based on the outdoor air temperature. When the outside ambient temperature exceeds the setpoint, the mode shifts to cooling. When the outdoor air dry-bulb temperature falls below this setpoint, the mode shifts to heating. This strategy while simple, often requires more complex controls and is incompatible with zones that have high internal cooling loads, such as call centers, banquet halls, auditoriums, and information technology spaces.

As with representative group changeover, this approach should also be avoided for applications with varying temperature zones such as dormitories, hotels, nursing homes, office space, or individual zones that require user commanded heating and cooling where zones would be best served by heat recovery

## Designing for Core and Shell

When designing for core and shell, the installing contractor and design team are often required to make educated guesses as to the future tenant buildout. Each new tenant has unique and unforeseen needs. A City Multi® two-pipe, heat recovery VRF system is a strategy that can be used to simplify the buildout, and reduce installation risk.

Many heat pump changeover strategies require installation of additional BAS hardware, front-end access, and custom programming. See page 48 for more information on controls.

A single City Multi branch controller may support up to 16 independent zones. The installing contractor is able to locate the branch controller with up to 16 branches in a central location. If needed, the system may be expanded with up to 11 sub-branch controllers. Installation can be further simplified by using pre-insulated flexible line sets from the branch controllers to the indoor units, with field installed service isolation valves at the branch controller. The initial installation will require a minimum of 50 percent combination ratio. During the early stages of the project, these are also used to maintain the minimum space temperature of the core and shell. If the initial buildout schedule is less than 50 percent combination ratio it's necessary to use multiple smaller units that comply with this requirement For more information on combination ratios, see page 16.

As the buildout progresses, simply relocate the existing indoor units, or add new branch lines and/or controllers as needed. However, in some installations performance or equipment challenges present themselves after a portion of the building is occupied. With some three-pipe systems, these changes may require removing, and reinstalling previously installed pipe. If the City Multi system does not require a sub branch controller, or the distance from the indoor unit to the sub branch controller is less than 196 feet, then changing the location and length of indoor units has no impact on previously installed pipe. Use of Diamond System Builder® during design can also mitigate this risk.

## Suitable VRF Applications

Common applications include schools, office buildings, government facilities, museums, historic retrofits, cultural facilities, multi-family structures, hotels, hospitality, churches, dormitories, nursing homes, tenant buildouts, high-end single-family dwellings, high performance buildings, health care, and more. The use of LEV kits with air handlers expands the application options to include large, open spaces, such as sanctuaries, gymnasiums, and auditoriums.

It is important to recognize VRF is not always the right fit for every application. Examples of applications where VRF might not make sense include laboratories with large amounts of makeup air or projects that require precise humidity or temperature control.

# Application Considerations

## Refrigerant Safety

Refrigerant safety is imperative for VRF systems because the quantity of refrigerant used is often greater than other terminal systems, such as conventional splits and rooftops.

ASHRAE® provides two standards, which describe properties of various refrigerants (Standard 34 “Designation and Safety Classification of Refrigerants”) and how refrigerants should be applied in various systems (Standard 15 “Safety Standard for Refrigeration Systems”). Often local jurisdictions adopt these standards into codes and ordinances making them required.

**Standard 34** defines a unique refrigerant concentration limit (RCL) for each refrigerant based upon its toxicity, flammability, and oxygen deprivation characteristics. The standard uses a letter system to show toxicity and a number to designate flammability. Designers must determine the RCL value for the refrigerant being used in the system.

**Standard 15** draws refrigerant safety classification and quantity limits from ASHRAE Standard 34. Similar to packaged DX systems and water source heat pumps, VRF has the potential to leak refrigerant to the occupied space. This requires VRF to follow ASHRAE Standard 15’s high probability rules. The standard includes unique requirements for institutional and industrial occupancies and limitations on placing components that contain refrigerant near corridors, stairwells, and means of egress.

The VRF system is evaluated as if the entire refrigerant charge would be released into the smallest room. The dilution volume of the room is computed then the concentration level of the entire leaked refrigerant charge is determined. If the resulting value is less than the refrigerant’s RCL value, the system is in compliance with Standard 15. If the RCL limit is exceeded, the designer must make changes such as select multiple units

When designing for core and shell never install a second branch controller or heat recovery device without one active indoor unit. Further, at startup the system combination ratio must be greater than 50 percent. Oil may become trapped in the dead leg, and unable to return to the condensing unit. Over time, this may lead to premature failure of system components.

with smaller refrigerant charges, use separate units for small spaces, or increase dilution by combining small spaces. This process is repeated for the next smallest room and continued until the calculated value exceeds the minimum RCL.

## Combination Ratio

When designing VRF projects it is critical to use a combination ratio to verify compliance with a manufacturer’s design rules and risk tolerance. This combination ratio metric expresses the nominal tonnage of the indoor units, versus the nominal tonnage of the condensing units. This metric is proportional to building load diversity. All manufacturers require a minimum 50 percent ratio, but maximum allowed varies dramatically. Diamond System Builder® generates combination ratios based on system design.

When sizing indoor units, the designer simply calculates the worst case or “peak load,” for heating and cooling each space then selects the indoor unit(s) that most closely matches both the peak load(s), and the architect’s considerations.

Due to diversity of the space, individual zones often experience peak operation during different times of the day. To account for this diversity, the designer calculates the design heating or cooling day “block load.” The block load is used to size the condensing unit, and is often less than the sum of all indoor peak loads.

A school is useful as a simplified example. The day begins with the sun on the east exposure with all students in classrooms. As the students go about their day, they move to different classrooms, the library, the cafeteria, and gymnasium. As the students move, each zone will experience periods of reduced occupancy. Throughout the day, the position of the sun also shifts—ending the day on the western exposure. In this example, each indoor unit experiences its peak load at unique time, compared to the other indoor terminal units. This is not an issue because the outdoor unit is sized for the block load, which provides enough capacity to the terminal units to ensure all spaces are conditioned.



VRF systems may have combination ratios less than 100 percent. An example of a low combination ratio is a core and shell project in the early stages of buildout, before tenant fit out.

Combination ratio should never be confused with capacity or safety factors. It is a mistake to expect additional capacity due to a high combination ratio. The condensing unit will only perform to its nameplate rating. On the hottest or coldest day of the year, a 10-ton system will only produce 10 tons.

### Combination Ratio Example

Consider an example with many indoor units. The indoor summed design peak capacity is 24 tons. A 20-ton condensing unit will be installed to serve the block load. The combination ratio is the indoor peak capacity divided by the block capacity, or 24 divided by 20, which results in a combination ratio of 120 percent.

Diamond System Builder® calculates this value in real-time, with a minimum value of 50 percent and a maximum value of 150 percent. Because the calculated combination ratio falls between the minimum and maximum values, this design is compliant.

## Cold Weather Operation

### Defrost

As the outdoor temperature approaches freezing while the air-source VRF condensing unit is in heating mode, or mainly heating mode, the outdoor coil will develop frost. This will initiate a defrost sequence. During defrost, the system is no longer producing heat to the interior, the system will modulate or stop the indoor fan to prevent cold drafts. For most installations, the tenants will not notice or recognize the temporary heat interruption.

If the ventilation requires continuous fan operation, it is possible to continue fan operation during defrost cycle. If this occurs, a best practice is to temper the return air to 60°F or warmer. When not possible, the BAS should automatically engage an auxiliary heat source.

Rotational defrost places one module in defrost, while leaving the remaining heat recovery modules in heat. If using a single module with a split condenser coil, that unit may also use rotational defrost. When configured, the indoor fans continue to run at low speed. This option may not be available for heat pump systems, and is not preferred for cold climates.

### Low Ambient/Cold Climate Heat Pumps

In order to meet climate initiatives some municipalities are adopting building codes that require the electrification of heat. The DOE Office of Energy Efficiency and Renewable Energy website states, “For many homeowners across the U.S., cold climate air-source heat pumps (ASHPs) can be a cost-effective option for improving home comfort while delivering energy and cost savings...”

VRF systems operate in heating mode down to as low as -22°F. All DX air-source heating systems experience decreased performance as the outdoor air dry-bulb temperature decreases. To address this, VRF manufacturers have developed “high heat” systems, which are optimized for heating-dominant applications. These “high heat” systems use variable speed technology along with flash injection to produce a very high percentage of nameplate heating capacity at low outdoor air dry-bulb temperatures. As the majority of the continental United States experiences heating design conditions warmer than -13°F, it may be possible to address the entire heating load without the use of boilers, electric resistance heat, or fossil fuels.

In installations where the expected dry-bulb temperature is colder than -13°F, it's possible to satisfy the heating load with the use of supplemental heat. The sequence of operation will call for the VRF heat pump as first stage heat. If the VRF system is unable to satisfy the demand an auxiliary second stage of heat is enabled.

## Air-Source VRF in a Mechanical Room

It may be desirable to locate air-source VRF condensing units within a penthouse or mechanical room for a variety of reasons, including building height considerations, sight lines, and sheltering equipment or maintenance staff.

The condenser heat must be exhausted from the mechanical space, which is typically accomplished by introducing outdoor air through an intake louver and discharging the exhaust air with ductwork. The condenser fans have a maximum external static pressure which is critical to the air distribution design. Additional concerns may include rain water management, freeze mitigation, damper construction, and louver design. For this reason the designer should contact the manufacturer for supplemental instructions, and consultations



## Low Ambient Cooling

Trane® / Mitsubishi Electric air-source products are rated for cooling down to 23°F. Heat recovery systems may achieve partial cooling loads down to -4°F. The heat recovery cooling capacity then becomes dependent on the heating operation. If the unit is heat pump or heat recovery operating in cooling or cooling main below 23°F, the use of low ambient hood and wind baffles help ensure operation to as low as -10°F.

The low ambient hood contains dampers that modulate condenser airflow. This maintains critical temperature and pressure requirements, which extend the cooling run hours. The wind baffles are installed to protect the active condenser coils from cold gusting wind. With these modifications, continuous cooling performance and restart are possible with very cold outdoor air conditions.

## Isolation Valves

Proactive steps are required to facilitate maintenance for VRF distributed DX piping systems. To ensure continuous operation during system maintenance and repair, the installer should provide isolation service valves throughout the system. In a heat recovery system, the common valve location is on the leaving side of the City Multi® Branch Controller. By placing the valve in this location, it is possible to isolate one indoor unit while leaving the remaining systems active. If the installation is a heat pump system, the correct valve location is immediately after a piping branch connection.

It is critical that these valves do not impart a pressure drop for the liquid refrigerant, as this may cause the refrigerant to prematurely “flash.” Instead, select a “full port” valve that is listed for the appropriate refrigerant. Further, the valve should have a service port to allow evacuation, and charging of the segregated pipe.

When installing these valves, it is tempting to locate the valve close to the indoor units. This practice is discouraged. It creates a section of “dead leg” pipe where oil may accumulate. If this condition were to exist for an extended period, it may lead to premature equipment failure.



## Refrigerant Piping

Each component within a VRF system, including the condensing unit, indoor units, and branch controllers, are connected by a series of refrigerant pipes.

VRF systems have the capacity for long line runs, and high lift. Single-phase systems may operate multiple units as far as 492 feet from the condensing unit. Three phase VRF systems may operate multiple units as far as 541 feet from the condensing unit. The three phase outdoor unit may have pipe risers as high as 295 feet below the condensing unit or 196 feet above the condensing units.

By using VRF indoor units, or LEV kits with built up air handlers, it is possible to address the zones that are otherwise inaccessible due to the location of the condensing unit. Examples of long line possibilities include large campuses such as universities, malls, hospitals, manufacturing, or other similar applications.

When designing for long lines with nonstandard VRF equipment, such as air handlers utilizing an LEV kit, the designer must consult the manufacturer's LEV kit guidelines. Following these written guidelines ensures adequate oil return, prevents overwhelming the condensing unit refrigerant accumulator, and ensures performance as predicted by design tools.

The designer should carefully consider the location and installation of refrigerant piping to ensure compliance with local codes and standards. These often include but may not be limited to the International Mechanical Code and ASHRAE® Standard 15 "Safety Standard for Refrigeration Systems."

### Distributed Piping Arrangements

VRF Systems use distributed refrigerant piping to serve multiple individual zones. As each project has different requirements, each project requires a custom piping layout. This custom layout may be extensive with over 3,000 feet of piping for a single system. To simplify design, and eliminate guesswork, the designer should use Diamond System Builder®. This tool will size the pipe, determine the volume of additional refrigerant, and ensure the installed piping lengths comply with minimum and maximum guidelines. Failure to use the design tool often results in poor performance, and premature equipment failure.

## Pressure and Vacuum Testing

VRF systems may contain in excess of 3,000 feet of connected pipe. To facilitate these large layouts, it is critical the system is moisture free and tightly constructed. This is demonstrated using pressure and vacuum testing of the field-erected piping prior to charging with refrigerant. All VRF manufacturers require demonstrating and documenting this test for warranty validation.

ASHRAE Guideline 41, "Design, Installation, and Commissioning of Variable Refrigerant Flow Systems," has developed an industry-wide consensus guideline for testing system integrity. The ASHRAE procedure calls for the installer to demonstrate and document the as-built installation is capable of holding a positive pressure of 600 psi or greater for 24 hours, and a negative pressure to 200 microns absolute for an additional 24 hours. During the demonstration, the positive pressure must not fluctuate more than 40 psi, and the negative pressure must not fluctuate more than 50 microns. If either of these thresholds are exceeded, the installer triple nitrogen purges the system, and repeats until demonstration and documentation of a successful test.

This test is also critical for VRF refrigerant safety. VRF systems use a distributed direct expansion arrangement. There is risk for systems serving small, enclosed spaces. While it is not possible to eliminate all leakage, following the Guideline 41 procedure is proven to be an effective leak risk mitigation strategy. This procedure when combined with ASHRAE Standard 15 requirements has enabled consultants to design safe compliant VRF installations.

Outdoor air, delivered to meet the ventilation requirement, is often at an unsuitable temperature and/or humidity condition to be delivered directly to the occupied zones and therefore requires some conditioning. Designers have a variety of choices with different levels of impact to the zone temperature and humidity conditions. VRF indoor unit sizing and operation are also impacted.

Designers may choose to supply conditioned outdoor air at a predetermined supply air dew point temperature, such as 55°F, or they may determine the supply air temperature based upon the zone humidity level desired.

## Acoustics

Sound levels for VRF systems can be lower compared to traditional split systems due to the use of variable-speed, low-sound fans, and variable speed compressors. Using variable speed technology allows for reductions at both full- and part-load conditions.

To address after hours noise ordinances City Multi® VRF systems offer a low noise feature. Depending on the unit, this feature allows the operator to control, and reduce the fan and compressor speed by multiple steps. The system will cancel the mode if critical temperature or pressure criteria are exceeded.

Ductless indoor units benefit from having small ECM direct drive fan motors. The customer has a choice to set a fixed constant speed, or using an algorithm to modulate from low, medium, high based on the delta difference between the space set point, and actual space temperature. If allowed to modulate, the fans typically spend the majority of run hours in the medium or low fan speed setting. This creates a very quiet environment, and may necessitate field-installed white noise generators.

### Three-pipe systems

While three-pipe systems have similar sequences, they do not have a vapor liquid separator in the heat recovery device. This requires all phase change to occur at the condensing unit. This also requires three pipes to transport refrigerant between the heat recovery device, and the condensing unit. The three pipes are for the hot gas line, a liquid line, and a low-pressure gas line.

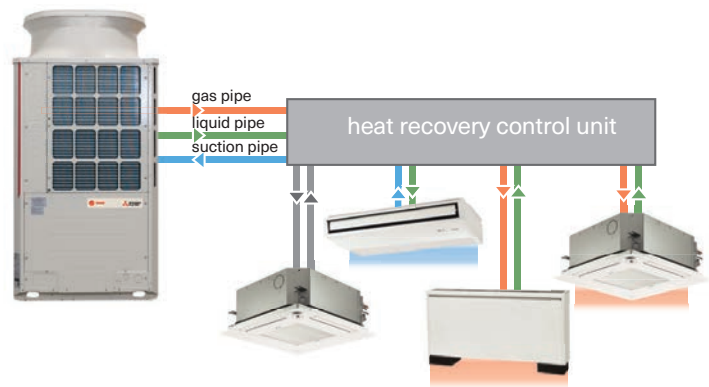

## Ground-source VRF

Ground-source systems take advantage of the earth's heat capacitance and heat transfer capability using the soil or surface water as the heat rejecter and heat adder.

With the advent of water-source-compressor units, ground-source VRF systems become a viable and attractive system option. It combines the best feature of ground-source and VRF systems.

Ground-source heat pump systems offer the potential for operating-cost savings when compared to a traditional cooling-tower-and-boiler system. To determine economic viability the installation costs for this system must be considered. In general, the largest portion of the installation cost is due to the ground-source heat exchanger. Installation requires excavation, trenching, or boring.

In a full ground-source-heat pump system, no cooling tower is necessary. From an architectural perspective, this allows all the heat from the building to be rejected without any visible sign of a cooling system. In addition, if the heat pumps can satisfy all building heating requirements, no boiler is necessary saving floor space.

However, sometimes the first cost of a full ground-source system is prohibitive or there is not adequate space available for the geo-source heat exchanger installation. In such cases, a hybrid system which reduces the size of the geo-source heat exchanger and includes a fluid cooler for additional heat rejection and/or a boiler as an additional heat source can reduce system first cost with little or no impact on annual operating cost resulting in much lower first cost and lower life-cycle cost. Because most commercial buildings are "cooling dominant" a ground-source sized for the heating load of the system with an auxiliary fluid cooler for additional heat rejection results in the optimum life-cycle cost.

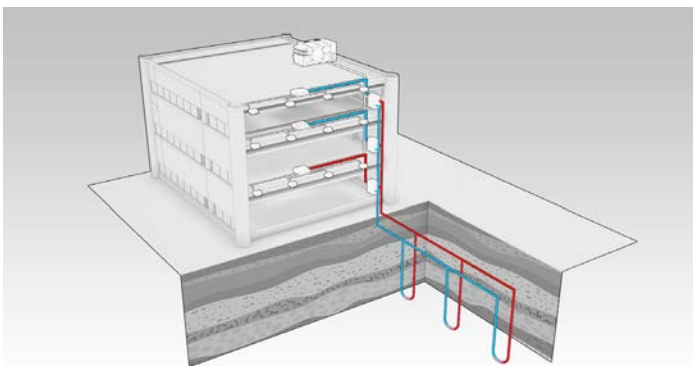

## Auxiliary Heat

Auxiliary heat may be used to supplement the VRF heat. Examples of common auxiliary heating include electric resistance heat installed within the zone or as a duct heater and baseboard hot water heat within the zone.

Designers may choose to include supplemental auxiliary heat for a variety of reasons, including:

- To serve as a backup heating system
- To take advantage of onsite heat or hot water
- Ensure adequate building heating capacity when the outdoor air dry-bulb is below the VRF system's minimum operational temperature

If the VRF system uses duct heaters for auxiliary heat, there are some special design considerations. Be cautious of staged heaters. As the VRF fan coil modulates between low, medium, and high fan speeds the discharge air temperature will also modulate. If the staged electric heater is sized for low fan speed, the discharge air temperature will fall when the ducted unit is in medium or high speed. This may feel cool, and uncomfortable to the tenants, resulting in comfort complaints.

If the staged electric heater is sized for high speed, when the fan coil is operating on low or medium speed it is possible to overheat the space, and duct work. This may lead to hot and dry complaints. Further, if the temperature continues to rise to an unacceptable level this may trigger the duct heaters high temperature safeties, and disabling heat.

A better option is to use SCR controlled duct heaters units. This allows the unit to be set a constant discharge air temperature. As the airflow modulates, the SCR controller will vary the performance to maintain setpoint. This strategy provides superior tenant comfort, and reduces nuisance complaints.

There are many applications that have a preexisting source of hydronic or steam heat. It may be desirable to use this "low cost" resource as first stage heat, and the VRF heat pump as second stage. This is possible with using the TAC-US444CN-1 VRF to third-party interface with a third party thermostat.

## Zoning

Heat recovery VRF allows divergent operation—where some zones may be heated while others may be simultaneously cooled. When this occurs, the heat recovery VRF system supplies hot gas to the heating unit, which will condense the gas to a liquid. The liquid refrigerant is then sent to the branch controller where it is subcooled and made available to the units, that require cooling. This ability to transfer energy is measured as the simultaneous heating and cooling efficiency (SCHE) rating, and is defined by AHRI Standard 1230. Higher ratings indicate better system energy transfer.

It is possible to optimize a heat recovery design by combining divergent zones on the same system. Consider an example where an application serves both eastern and western exposures. In the morning, it is common for the shaded western exposure to require heat, while the sun-exposed eastern exposure requires cooling. When combined on a single system, it is possible to transfer energy between these divergent zones.

Another common example is an application with offices around the exterior perimeter and a larger cooling-dominant interior space. If the designer uses VRF, it is possible to divide the cooling-dominant space into multiple smaller sub-zones. Each sub-zone is then combined with an exterior zone. The benefit

is the exterior zone is heating dominant during the winter months, and will transfer energy with its associated interior zone. Using this strategy may also promote diversity in the design.

As with any design, there are multiple considerations. In the previous example, the designer combined multiple zones to promote SCHE functionality, the tradeoff is longer pipe runs. This may increase the installation cost. An alternative strategy combines each of the exterior zones in a northwest and southeast strategy. It is still possible to take advantage of the diversity of the solar loads when using heat recovery VRF. Further if the interior zone is a single large homogenous space it is possible to segregate this to one zone as a heat pump system. This simplifies design and cost.

An important note, the previous example insists the interior zone is a single homogenous zones, i.e.: large call center, library, cafeteria, and open office area. If the interior zone consists of multiple small offices or conference rooms, there is still significant divergence between the individual spaces. Many years of VRF experience has shown using heat pump systems for divergent spaces is a misapplication, and rarely has satisfactory outcomes.

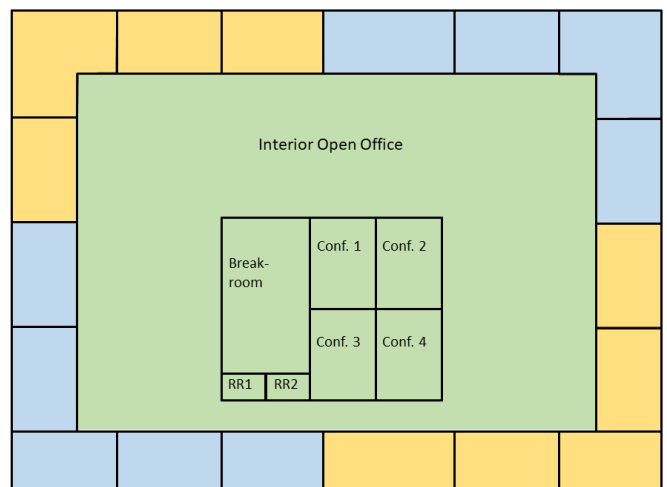
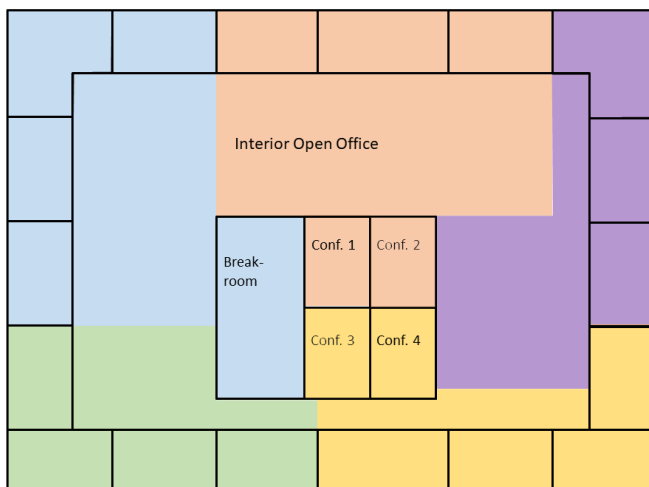

## Economizing with VRF

Economizing may be required by the local energy code or standard. ASHRAE's Standard 90.1 and ICC's IECC require a free cooling economizer (air or water) to be used when the individual fan-cooling unit (indoor unit) system surpasses 54,000 Btu/hr or 4.5 tons. VRF indoor units are generally smaller than this threshold and are often exempt.

Airside economizing with terminal units is challenging as the ventilation duct work must be sized to deliver for both the 100 percent design supply airflow, and the minimum ventilation airflow. When the unit capacity exceeds 4.5 tons, an alternative strategy may be to use blower coils or central station air handlers with VRF LEV kits. This allows the use of economizer mixing boxes, and simplifies the design.

ASHRAE® Standard 90.1 and IECC offers another exception based on condensing unit efficiency. If a VRF indoor unit surpasses the size threshold and the condensing unit exceeds the minimum efficiency requirement by the prescribed percentage improvement, then the economizer may be eliminated. This percentage varies by climate zone.

Economizing with a DOAS will likely not satisfy the current standard and code requirements for air economizing because ventilation distribution systems are typically not designed to provide 100 percent of the design supply air quantity as outdoor air for cooling. Trane Horizon® DOAS can provide ventilation free cooling, where the design ventilation airflow is provided without mechanical cooling during cold and mild weather. This cool or cold supply air meets the ventilation requirements while also offsetting some or all of the zone cooling loads, allowing the VRF terminals to cycle on or off, or operate at reduced loads.

## Installer Training

To ensure system longevity and performance, it is critical to follow the manufacturer's published installation instructions. Trane® and Mitsubishi Electric Trane US, LLC has created one of the largest nationwide VRF training networks to educate the installer. Installers who complete factory training qualify for extended warranties of up to ten years. Prior to installation, the design team should specify that the installing contractor has provided proof of installation certification.

# Humidity Control

Outdoor air, delivered to meet the ventilation requirement, is often at an unsuitable temperature and/or humidity condition to be delivered directly to the occupied zones and therefore requires some conditioning. Designers have a variety of choices with different levels of impact to the zone temperature and humidity conditions. VRF indoor unit sizing and operation are also impacted.

Designers may choose to supply conditioned outdoor air at a predetermined supply air dew point temperature, such as 55°F, or they may determine the supply air temperature based upon the zone humidity level desired.

## Ventilation Options

Designers have several options to provide ventilation air to the occupied spaces, including:

### Supply unconditioned outdoor air to the VRF indoor units.

In this configuration, outdoor air is ducted to each VRF indoor unit or the VRF indoor unit features an outdoor air opening and damper arrangement to allow some outdoor air to be mixed with the recirculated air.

If untreated outdoor air is ducted straight into the occupied zone, it may become a significant source of sensible and latent load during hot and humid days. This will increase zone sensible and latent loads, which results in the need for a larger VRF indoor unit. Zone humidity may rise to unacceptable levels when humid outdoor air is supplied to the zone without treatment.

If untreated outdoor air is ducted to the VRF unit, the indoor unit must be sized to offset the additional sensible and latent loads. In addition to this, attention must be paid to outdoor air duct sizing to ensure adequate ventilation air can reach the indoor unit.

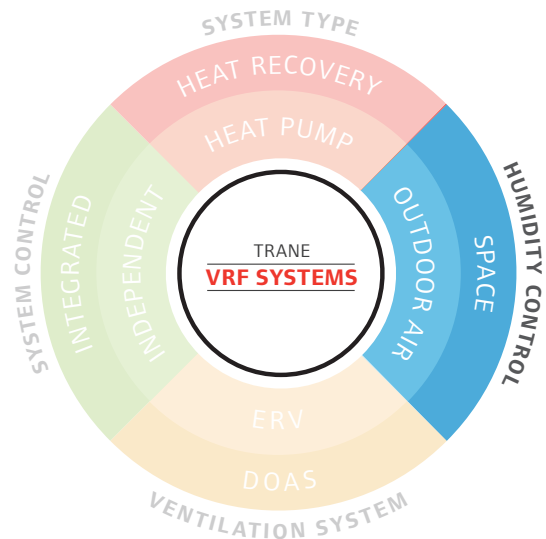

**Use an energy recovery ventilator (ERV) to condition the outdoor air.** Energy recovery ventilators (ERVs) are packaged heat recovery devices, which transfer heat between two airstreams. A variety of energy recovery technologies are used, some of which transfer sensible and latent heat between airstream. When used to precondition outdoor air, heat and moisture are transferred between the outgoing exhaust air stream and incoming outdoor air stream. During the cooling season, heat and humidity are transferred from the outdoor airstream to the cooler, drier exhaust air stream, reducing the dry-bulb temperature and humidity ratio of the entering outdoor air. During the heating season, heat and humidity are transferred from the exhaust air stream to the outdoor air stream, increasing the dry-bulb temperature and humidity ratio of the entering outdoor air.

Sensible-only devices include fixed plate heat exchangers, heat pipes, and coil-runaround loops. Total energy recovery devices, which transfer both sensible and latent heat, include total energy wheels and membrane-style fixed plate heat exchangers.



To ensure airflow through both sides of the heat exchanger, a fan may be used. As a result, ERVs often have two fans to move incoming outdoor air and exhaust air through the device.

ERVs have limited control of outdoor air pretreatment. Some models include capacity control, but they are not able to maintain desired leaving air conditions throughout the entire operating envelope, like a dedicated outdoor air system.

**Use a dedicated outdoor air system (DOAS) to condition the outdoor air.** Dedicated outdoor air systems (DOAS) are systems that cool, dehumidify, and heat the outdoor airstream independently of the recirculated airstream. These devices allow the ventilation loads to be decoupled from the other building heat loads, such as internal and envelope loads. A DOAS sufficiently dehumidifies and tempers the outdoor air to meet both the latent load and the ventilation requirements for all spaces served by the system. Separating the building's cooling load makes it easier to effectively ventilate and dehumidify occupied spaces. A DOAS can be designed to deliver conditioned outdoor air directly to each occupied space or to the individual VRF terminals serving those spaces.

DOAS may be equipped with energy recovery devices. Heat transfer is accomplished as the exhaust and outdoor air streams pass through the energy recovery device. Heat transfer may be sensible-recovery only, meaning only the dry-bulb temperature is affected by heat exchange, or total recovery, in which both sensible heat and moisture are transferred between the two air streams.

Lossnay ERV



Trane dedicated outdoor air systems



# Humidity Control Strategies

## Space Humidity Control

In most applications, in most climates, the DOAS is sized to dehumidify the outdoor air to remove the latent load from the entering outdoor air, and is often then dehumidified a little further. In this case, the resulting dew point of the conditioned air is drier than the space, dry enough that this quantity of outdoor air also removes most, or all, of the space latent loads. In an outdoor humidity control application, the dedicated outdoor air system is controlled to maintain a supply air dew-point temperature at a pre-determined value, such as 55°F.

## Outdoor Air Humidity Control

In some cases, the local VRF terminals may also help to dehumidify the space when the sensible-cooling load is high, yielding an indoor humidity that is drier than the maximum upper limit. As a rule of thumb, size the dedicated outdoor air unit so that it offsets both the ventilation load and the space latent loads at the peak outdoor-enthalpy condition. A system that controls humidity based upon space conditions maintains space humidity at all loads. This is accomplished by resetting the dedicated outdoor air system supply air dew-point temperature to maintain the desired space humidity setpoint. To size equipment, the designer must analyze the space loads at full- and part-load conditions to determine the required control setpoint.

Designers can select DOAS to supply warm, neutral air, or cool, dry air to the zone. The resulting zone conditions and terminal unit size are affected by the DOAS supply air dry-bulb temperature and dew-point temperature. A colder supply air condition from the DOAS partially offsets the space sensible cooling loads, allowing the VRF terminal units to be sized smaller.

### Designing a dedicated outdoor air system

A seven-step process to select a dedicated outdoor air system and corresponding leaving air conditions is outlined within Trane's "Dedicated Outdoor Air Systems" application guide (SYS-APG001\*-EN).

The process includes selecting the correct outdoor air design conditions, identifying design zone humidity conditions, and evaluating space latent loads to determine the required dew point temperature for the conditioned outdoor air.

The free Application Guide can be accessed at [www.trane.com/Horizon](http://www.trane.com/Horizon).

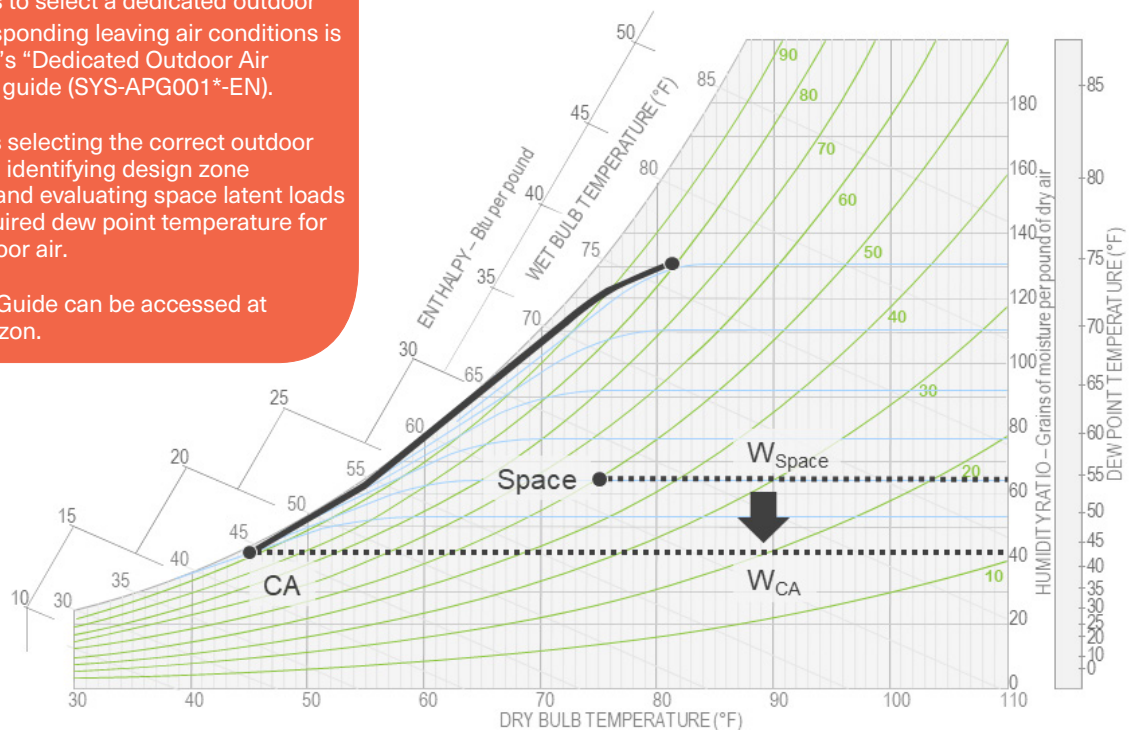

## Cold or Neutral Air?

The DOAS should dehumidify outdoor air so that it is drier than the zone. A by-product of dehumidifying outdoor air is cooling (OA to DH), but many designers choose to reheat the dehumidified air to a “neutral” dry-bulb temperature (DH to CA) closer to the zone setpoint. While delivering the dehumidified air at neutral temperature can simplify controls, it also wastes sensible cooling provided by the DOAS.

If the DOAS supplies air directly to each zone or to the supply-side of a VRF indoor unit, the dehumidified outdoor can be delivered “cold” rather than reheated to “neutral” by the DOAS. The cool supply air offsets some of the zone sensible cooling load, often allowing the indoor unit to be downsized and sized for less airflow and cooling capacity.

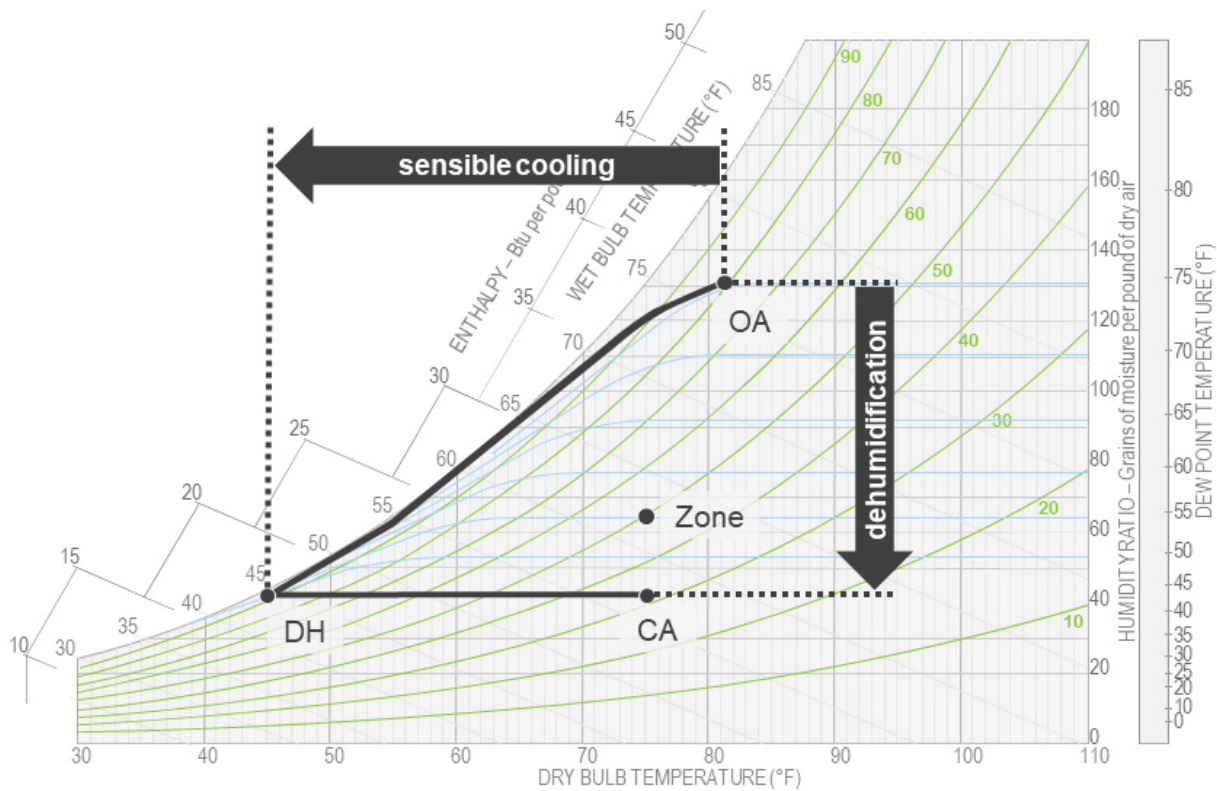

### Maximum leaving air temperature limited in recent building energy standards and codes

The committee responsible for writing ANSI®/ASHRAE®/Standard 90.1-2016 added a prescriptive requirement (Section 6.5.2.6) limiting the maximum supply air temperature for a DOAS when operating with zone heating and cooling systems, such as VRF. The requirement prohibits the use of reheat or heat recovery “to warm the supply air above 60°F when representative building loads or outdoor air temperature indicate that the majority of zones require cooling.” The 2018 International Energy Conservation Code® includes a similar requirement.

## Using Cold Supply Air

**The use of cold supply air provides some advantages, when compared to neutral-temperature air:**

**Requires less overall cooling capacity.** The required capacity of the DOAS unit is the same, regardless of whether the dehumidified air is reheated by hot-gas reheat to room neutral or not, but the required cooling capacity of each local unit is less in a cold-air system when compared to a neutral-air system.

**Requires less overall cooling energy for much of the year.** VRF indoor units use less energy to provide cooling at each local unit when the DOAS supplies cold conditioned air. A neutral-air system wastes the sensible cooling benefit by reheating the cold, dehumidified air.

**Requires less overall fan airflow and, therefore, less fan energy.** For zones that require seasonal cooling and heating, the design supply airflow delivered by the VRF indoor unit is less in a cold-air system when compared to a neutral-air system, which results in less fan energy consumption. For zones that require year-round cooling, the local VRF indoor unit may not be downsized as much, because it may be sized based upon the warmest DOAS supply air temperature expected.

**There are situations when a DOAS will need to reheat the dehumidified conditioned air:**

**To avoid overcooling at part-load conditions.**

Delivering cold conditioned air, at dry-bulb temperatures colder than the zone temperature, offsets some of the zone sensible cooling load. As this sensible load decreases due to changes in outdoor conditions, solar heat gain, and internal loads, it's possible that the cold, conditioned outdoor air may provide more sensible cooling than is required, which results in overcooling the zone. There are several strategies that can be used to avoid overcooling including:

- the use of DOAS heat/reheat to temper the conditioned air
- the use of discharge air temperature reset to increase the DOAS supply air dry-bulb temperature
- the use of demand-controlled ventilation to reduce the quantity of outdoor air delivered to the zone
- the use of VRF indoor unit heating
- the use of auxiliary zone heating

**In applications where zone sensible cooling loads differ greatly at any given time.** When the DOAS

serves zones where sensible cooling loads can vary dramatically between the different zones served, such as hotel guest rooms and dormitories, delivering cold conditioned air may result in frequent overcooling for some zones. For these applications, it may be simpler to reheat the conditioned outdoor air to a neutral temperature because the benefit of cold air delivery occurs less frequently.

In zones where the sensible cooling load is high during daytime hours, such as classrooms and offices, the use of cold air provides more benefit. The conditioned air may be reheated as zone loads decrease, if demand controlled ventilation is not employed to reduce outdoor air volume as zone population decreases.

**In applications that require lower-than-normal dew point temperatures.** Very low dew-point temperatures may be required in certain applications. The DOAS must create very cold air to sufficiently remove the latent load and meet the dew-point temperature requirement. The resulting dry-bulb temperature of the air leaving the cooling coil may be colder than the designer is comfortable—below 45°F, for example. The dehumidified outdoor air could be reheated to a warmer dry-bulb temperature that remains cooler than the zone—55°F, for example.

**To avoid condensation when conditioned outdoor air** is delivered to the ceiling plenum. If cold air is supplied by the DOAS to a ceiling plenum, near one or more terminal units, it is allowed to mix with recirculated air in the plenum. The conditioned air may need to be reheated above the expected dew-point temperature of the surrounding air within the plenum. If infiltration is expected within the plenum due to wind effects, exhaust fan operation, or the DOAS not operating, condensation may form as humid, untreated outdoor air leaks through the envelope.

## Reduce or Eliminate DOAS Reheat

Consider delivering conditioned outdoor air to the zones cold, and not reheated to room-neutral conditions whenever possible. Delivering cold air to the zones offsets some sensible cooling loads, while also offsetting latent loads. This allows VRF equipment to be downsized. Using reheat wastes energy if cooling is needed within the zone. There are cases when reheat is needed to temper the conditioned outdoor air, such as:

- Some or all zones are at very low sensible cooling loads requiring warmer DOAS supply air (to prevent overcooling the zones)
- Majority of zones are in heating mode

To reduce or eliminate the need for reheat, consider one or several of the following strategies:

**Discharge air temperature reset.** During periods of mild weather or when the majority of VRF terminals are heating, the discharge air temperature of the DOAS is reset upward to reduce the amount of sensible cooling provided by the outdoor air. To ensure adequate dehumidification on a humid day, reheat could be used to sensibly heat the air from the supply air dew-point temperature setpoint to a warmer supply air dry-bulb temperature.

**Air-to-air energy recovery.** Air-to-air energy recovery devices can be used to reclaim heat from the exhaust air stream and reheat the dehumidified supply air, downstream of the cooling coil, before being supplied to the zones. Sensible-only devices include fixed plate heat exchangers, heat-pipes, and coil-runaround loops.

# Psychrometric Analyses

## Impact of Different Supply-Air Conditions at Cooling Design and Full Load

The table below shows four DOAS supply-air conditions evaluated with psychrometric analyses. The impact of these conditions upon the ERV/DOAS, VRF indoor unit sizing, and the resulting zone humidity at varying space loads is shown.

Consider an example of a 1000-ft<sup>2</sup> conference room in an office building in Atlanta, Georgia. Design occupancy is 25 people. Conference rooms typically have low outdoor airflow rates per person compared to other space types and as a result, pose large dehumidification challenges.

To ventilate the conference room, the ERV/DOAS will deliver 185 cfm of outdoor air directly into the zone. The conference room cooling setpoint is 75°F, with a desired humidity level of 50 percent relative humidity, which equates to a humidity ratio of 67.3 gr/lb. Using a whole building load and energy analysis software programs such as TRACE® 3D Plus, a design sensible cooling load of 11,800 Btu/hr and design latent load of 3,900 Btu/hr has been computed. A VRF terminal supply-air temperature of 57°F has been selected to ensure the supply air humidity ratio is less than the desired zone humidity ratio, which allows the indoor unit to provide some dehumidification.

Impact of ERV and DOAS Supply-Air Conditions on Conference Room Humidity at Full- and Part-Load Conditions<sup>(1)</sup>

	ERV			DOAS		
ERV/DOAS Supply-air conditions	81.7°F DBT (81.7°F DBT/63.4°F DPT/91.3 gr/lb)	77.2°F DBT (77.2°F DBT/70.3°F DPT/116.5 gr/lb)	77.2°F DBT (77.2°F DBT/71.2°F DPT/119.7 gr/lb)	70°F DBT (70.0°F DBT/66.5 DPT/101.6 gr/lb)		
Space loads (sensible/latent, Btu/hr)	11,800 3,900	7,800 3,900	6,125 3,900	11,800 3,900	7,800 3,900	6,125 3,900
Space SHR	0.752	0.667	0.611	0.752	0.667	0.611
Space load offset by ventilation system <sup>(2)</sup> (sensible/latent, Btu/hr)	-1,345 -1,953	-442 -3,140	-442 -2,553	1,004 -2,578	1,004 -1,889	1,004 -1,060
Loads offset by VRF terminal unit (sensible/latent, Btu/hr) <sup>(3)</sup>	13,145 5,853	8,242 7,040	6,567 6,453	10,796 6,478	6,796 5,789	5,121 4,960
VRF terminal airflow, cfm <sup>(4)</sup>	673	505	505	553	415	415
Resulting space relative humidity <sup>(5)</sup>	56.7%	67.7%	73.3%	62.0%	68.6%	73.3%

<sup>(1)</sup> Cooling design weather: ASHRAE® 0.4% design cooling weather: 94.0°F dry-bulb temperature/74.2°F wet-bulb temperature at an altitude of 1,057 feet. Part-load weather: ASHRAE 0.4 percent design dehumidification weather (74.3°F DPT/81.3°F MCDDBT) to account for worst-case outdoor air humidity.

<sup>(2)</sup> A negative value indicates load is added to the zone because the outdoor air has not been cooled and/or dehumidified to a supply condition below the desired space conditions.

<sup>(3)</sup> Values used in this example are illustrative and may not reflect actual equipment performance.

<sup>(4)</sup> For this analysis, the two-speed terminal unit operates at minimum speed at part load conditions, which is 75 percent of design airflow.

<sup>(5)</sup> The desired zone relative humidity at design is 50 percent. Space relative humidity above 65 percent are shaded in red, values between 65 and 55 percent shaded in yellow, and under 55 percent shaded in green.

## Impact of Different Supply-Air Conditions at Part Load

When it is hot outside, the ventilation sensible cooling load often exceeds the latent load. When it is cooler but humid outside, the latent load often exceeds the sensible cooling load. Sensible and latent ventilation loads do not peak at the same time. For these reasons, the DOAS should be evaluated at both cooling and dehumidification design conditions.

The same conference room is analyzed at part-load with 0.4 percent design dehumidification weather conditions. The Atlanta, Georgia design dehumidification dew-point temperature is 74.3°F with a mean coincident dry-bulb temperature of 81.3°F.

To analyze part-load conditions, the internal and lighting loads have been reduced so the sensible load is less than

design. The design sensible load for this space is 11,800 Btu/hr. At the first part-load condition, the space sensible load was reduced to 7,800 Btu/hr, resulting in a space sensible heat ratio (SHR) of 0.667. At the second part-load condition, the space sensible load was reduced to 6,125 Btu/hr, resulting in a SHR of 0.611. (This value was chosen to represent the people design load, which includes the corresponding design latent load.) In this analysis, the DOAS has been appropriately sized to always provide the required supply-air conditions.

As the space sensible load decreases, the VRF terminal performs less dehumidification because it is controlled to maintain space temperature (sensible load, only).

55°F DBT (55.0°F DBT/54.4 DPT/65.5 gr/lb)			50°F DBT (50.0°F DBT/49.5 DPT/54.5 gr/lb)			45°F DBT (45.0°F DBT/44.5 DPT/45.0 gr/lb)			
11,800	7,800	6,125	11,800	7,800	6,125	11,800	7,800	6,125	
3,900	3,900	3,900	3,900	3,900	3,900	3,900	3,900	3,900	
0.752	0.667	0.611	0.752	0.667	0.611	0.752	0.667	0.611	
4,015	4,015	4,015	5,018	5,018	5,018	6,022	6,022	6,022	
945	2,323	3,064	2,017	2,923	3,574	2,829	3,676	3,676	
7,785	3,785	2,110	6,782	2,782	1,107	5,778	1,778	103	
2,955	1,577	836	1,883	977	326	1,071	224	224	
399	299	299	347	260	260	296	222	222	
54.2%	62.0%	66.2%	52.1%	57.5%	61.2%	49.8%	54.8%	54.8%	

## ERV at full load

The ERV cools and dehumidifies the outdoor air as it passes through the air-to-air heat exchanger (OA to CA). Because there is no mechanical cooling system, as found in the DOAS, the leaving-air conditions are dependent upon the outdoor air conditions. At the ASHRAE® 0.4 percent cooling design conditions (OA), the leaving-air conditions are computed to be 81.7°F dry-bulb temperature and 91.3 gr/lb (CA). These conditions are above the desired space dry-bulb temperature and humidity conditions, which results in sensible and latent loads added to the space by the ERV. These loads must be offset by the VRF indoor unit, and is reflected in the indoor unit design capacity and airflow. Conditioned outdoor air (CA) mixes with conditioned recirculated air from the VRF system (CC) to make the mixed air condition (MA). After a psychrometric analysis of the entire system, the zone relative humidity arrived at 55.3 percent at design (compared to the desired target of 50 percent).

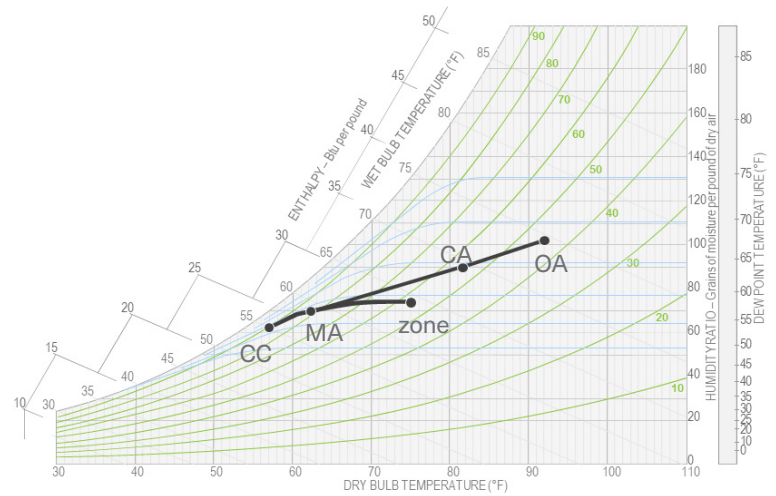

- OA: outdoor air
- CA: conditioned outdoor air from ERV or DOAS
- Zone: space conditions
- CC: VRF terminal unit supply air
- MA: mixed air condition resulting from the mixing of conditioned ERV/DOAS air (CA) and VRF terminal unit supply air (CC).



## ERV at part load

At part load, the ERV is analyzed using ASHRAE® 0.4 percent design dehumidification weather conditions. Because there is no mechanical cooling system, the leaving air conditions are computed to be 77.2°F dry-bulb temperature and 116.5 or 119.7 gr/lb for the two part-load cases.

These conditions are above the target space dry-bulb temperature and humidity ratio, which results in sensible and latent loads added to the space by the ERV. These loads must be offset by the indoor unit. At the part-load condition where the SHR is 0.667, the resulting space humidity is 67.7 percent. As the SHR becomes “steeper” at 0.611, and space sensible load approaches the latent loads the terminal provides less dehumidification and the result is a higher space relative humidity at 73.3 percent.

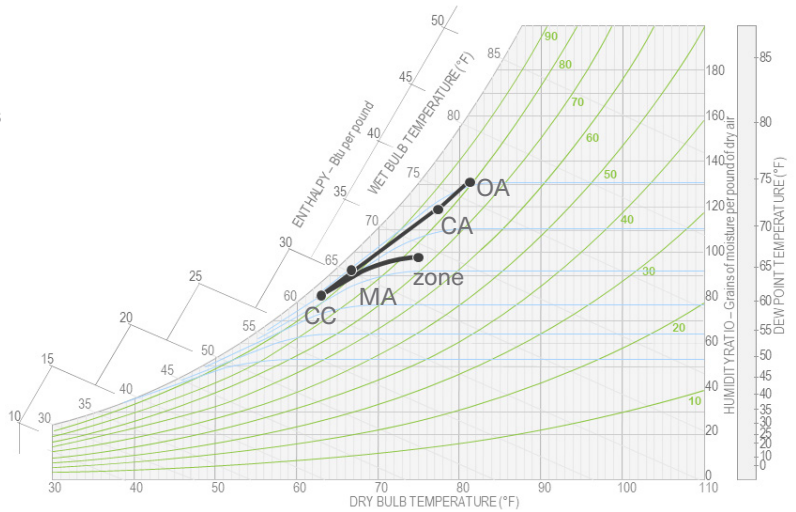
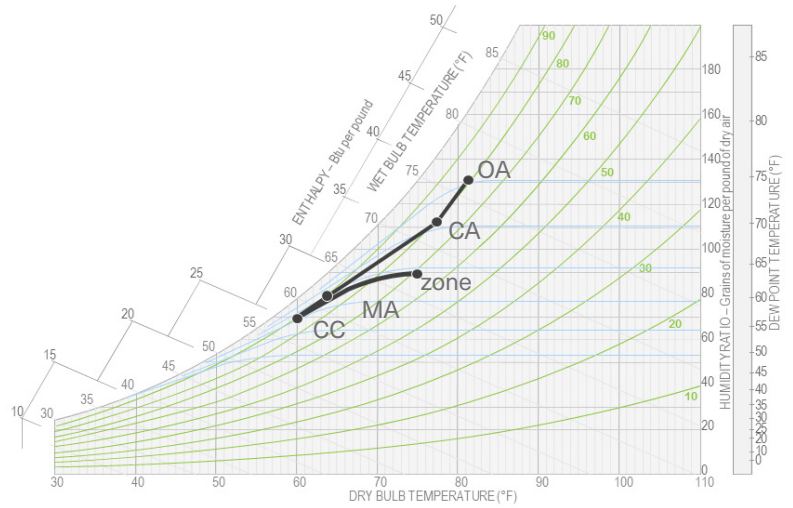

## DOAS

Moving left to right in the table on pages 30 and 31, the DOAS supplies colder, drier air, resulting in more dehumidification and coincidental cooling. That is, the colder DOAS supply-air dry-bulb temperature offsets more of the zone sensible cooling load, allowing the VRF indoor unit to be a smaller size. This also allows the indoor unit fan to be downsized.

The DOAS can maintain the desired zone humidity when the designer selects a supply-air condition that is sufficiently dry. For example, just cooling the conditioned air to 70°F dry bulb in the first scenario results in air supplied at 101.6 gr/lb. This adds latent load to the zone, as it is well above the desired zone humidity level. In comparison, dehumidifying the conditioned air to a drier

condition, such as 55°F dry bulb and 65.5 gr/lb (54.4°F dew point) offsets some zone latent load, but not enough to reach the desired zone humidity condition of 67.3 gr/lb (50 percent relative humidity at 75°F). Supplying air at an even drier condition, such as 45°F DBT and 45.0 gr/lb (44.5°F dew point), allows the conditioned air volume to offset the zone latent load and maintain the desired zone humidity level.

As shown in the table below, progressively colder and drier DOAS supply air conditions yield smaller VRF indoor unit capacity requirements and airflows, because the conditioned air is offsetting more of the zone sensible and latent loads. The use of smaller VRF terminals may even reduce the required refrigerant pipe sizes and charge.

Impact of DOAS Supply-Air Conditions on Terminal Size

	ERV	DOAS			
		70.0°F DBT (70.0°F DBT/66.5 DPT/101.6 gr/lb)	55.0°F DBT (55.0°F DBT/54.4 DPT/65.5 gr/lb)	50.0°F DBT (50.0°F DBT/49.5 DPT/54.5 gr/lb)	45.0°F DBT (45.0°F DBT/44.5 DPT/45.0 gr/lb)
VRF indoor unit design capacity, tons	1.6	1.4	0.9	0.7	0.6
VRF indoor unit design airflow, cfm	673	553	399	347	296

## DOAS at Full Load

**70°F dry-bulb temperature/66.5°F dew-point temperature.** Outdoor air enters the DOAS and is cooled to 70°F dry bulb/66.5°F dew point. The change in humidity ratio is nearly negligible, indicating very little dehumidification of the outdoor air occurs. Moreover, because the humidity ratio of the conditioned outdoor air is higher than the desired zone humidity ratio, latent load is added to the zone. With these DOAS supply-air conditions, the VRF indoor unit must be sized to offset 1.4 tons of cooling load at 553 cfm. Throughout operation, the VRF indoor unit will likely have to provide the majority of the dehumidification, resulting in frequent high zone humidity levels. After a psychrometric analysis of the entire system at design conditions, the zone relative humidity arrived at 62.0 percent at design (compared to the desired target of 50 percent).

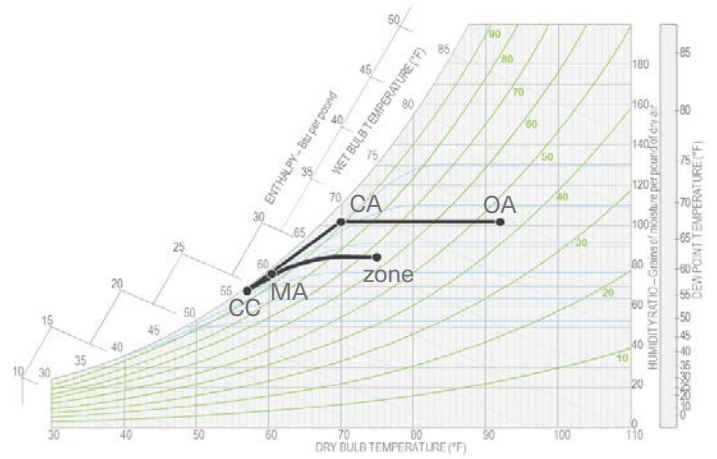

**55°F dry-bulb temperature/54.4°F dew-point temperature.** Outdoor air enters the DOAS and is cooled and dehumidified to 55°F dry bulb/54.4°F dew point. Unlike the previous scenario, the DOAS provides some dehumidification to offset the zone latent loads. With these DOAS supply-air conditions, the VRF terminal must be sized to offset 0.9 tons of cooling load at 399 cfm. After psychrometric analysis of the entire system, the zone relative humidity arrived at 54.2 percent at design conditions (compared to the desired target of 50 percent).

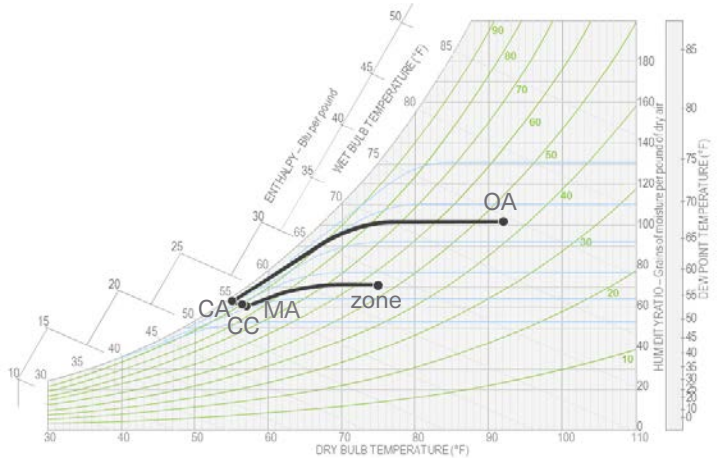

**50°F dry-bulb temperature/49.5°F dew-point temperature.** Outdoor air enters the DOAS and is cooled and dehumidified to 50°F DBT/49.5°F DPT. With these DOAS supply-air conditions, the VRF terminal must be sized to offset 0.7 tons of cooling load at 347 cfm. After psychrometric analysis of the entire system, the zone relative humidity arrived at 52.1 percent at design conditions (compared to the desired target of 50 percent).

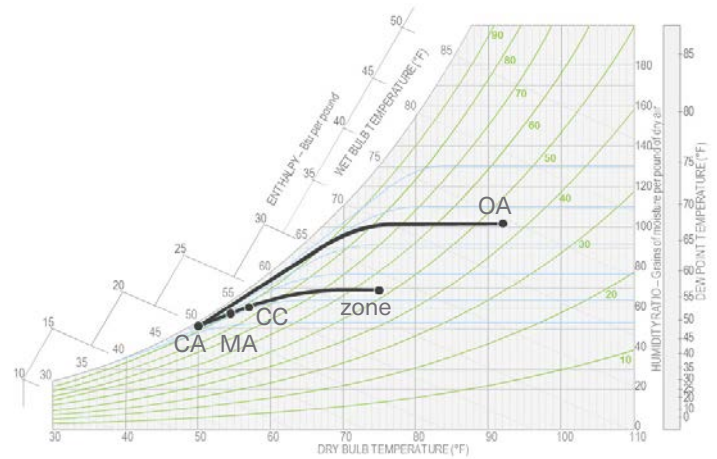

**45°F dry-bulb temperature/44.5°F dew-point temperature.** Outdoor air enters the DOAS and is cooled and dehumidified to 45°F DBT/44.5°F DPT. With these DOAS supply air conditions, the VRF terminal must be sized to offset 0.6 tons of cooling load at 296 cfm. After psychrometric analysis of the entire system, the zone relative humidity arrived at 49.8 percent at design conditions (compared to the desired target of 50 percent).

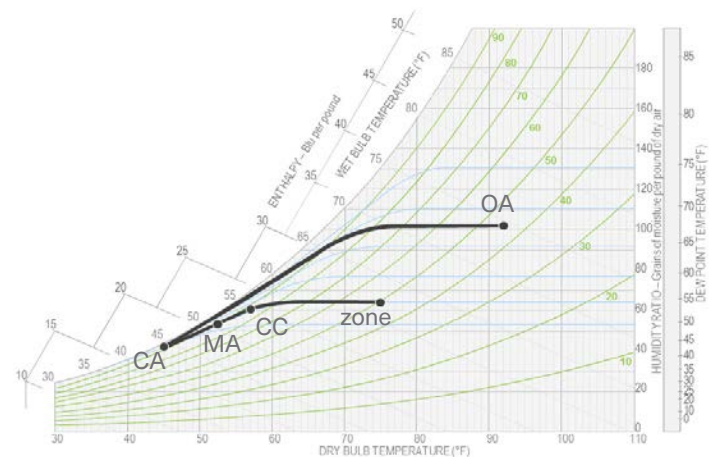

## DOAS at Part Load

Similarly, at part-load conditions, the resulting space relative humidity level rises above the design target of 50 percent. As the SHR becomes “steeper” and space sensible load approaches the latent load, the VRF terminal provides less dehumidification, which results in higher space relative humidity levels.

DOAS: 70°F supply air: Part load 0.667 SHR

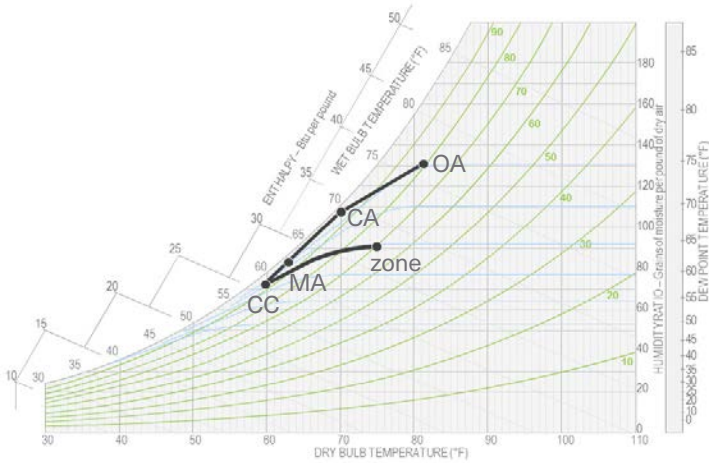

DOAS: 70°F supply air: Part load 0.611 SHR

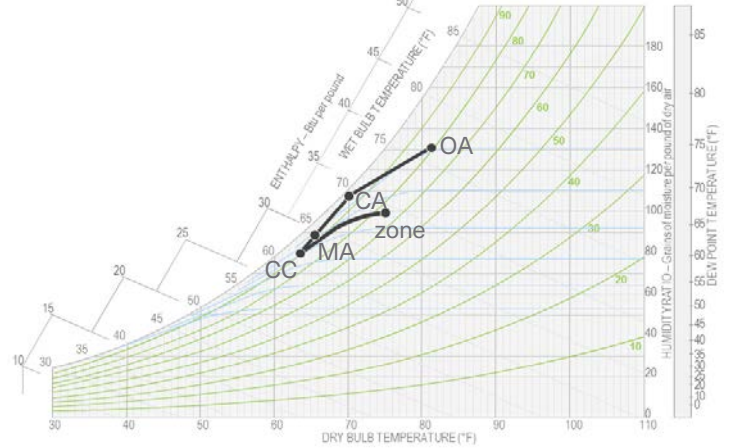

DOAS: 55°F supply air: Part load 0.667 SHR

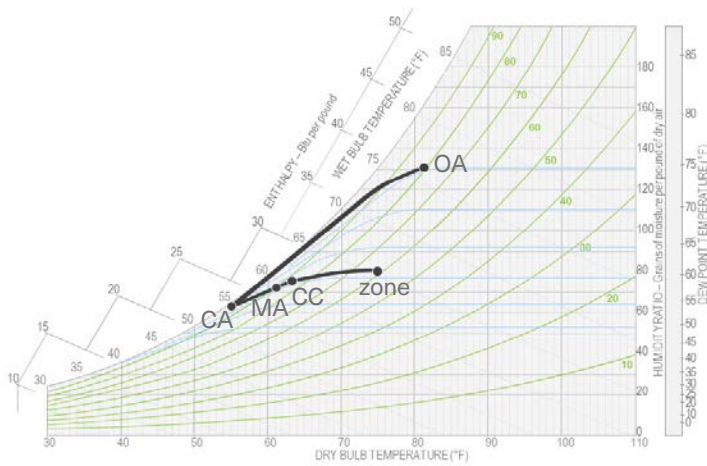

DOAS: 55°F supply air: Part load 0.611 SHR

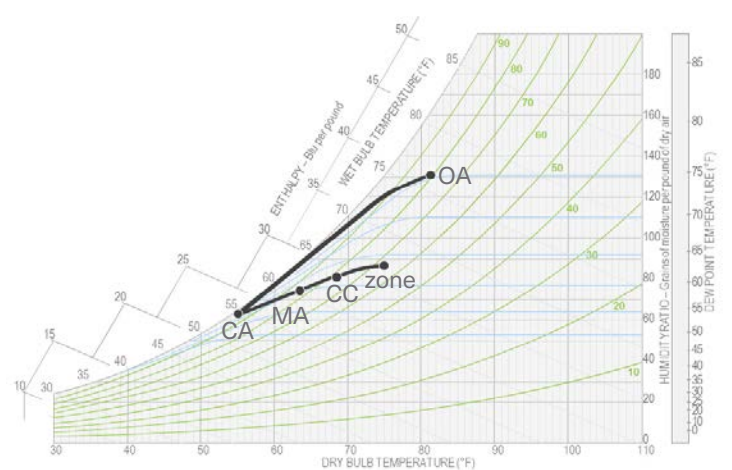

DOAS: 50.0°F supply air: Part load 0.667 SHR

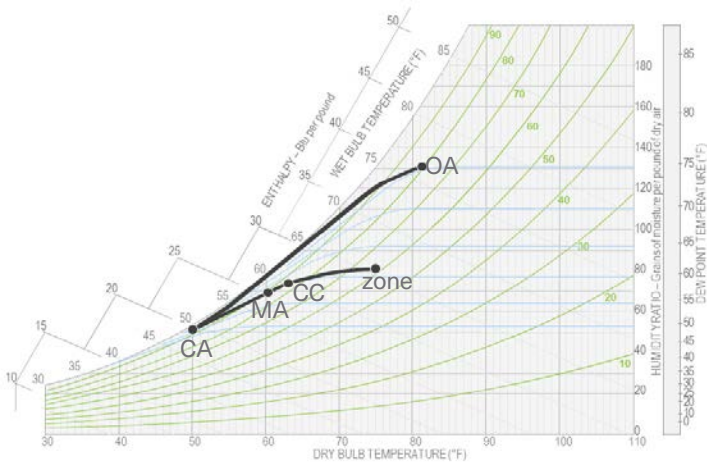

DOAS: 50°F supply air: Part load 0.611 SHR

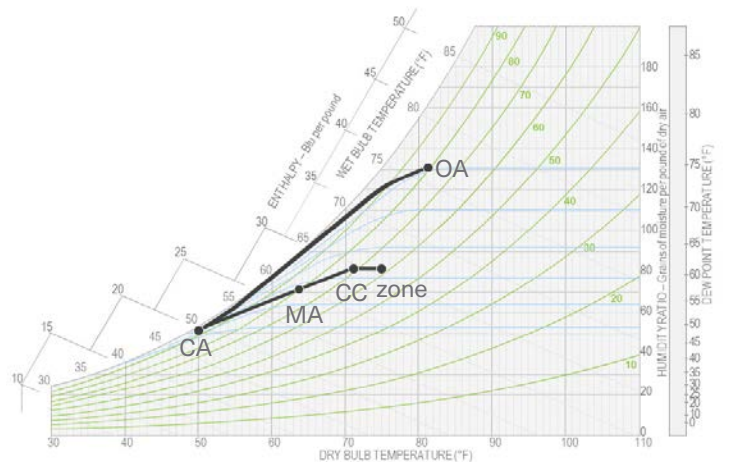

At the 45°F supply-air condition, the DOAS provides the majority of space sensible cooling and dehumidification. As space sensible loads decrease, the VRF terminal supply-air temperature can be increased and/or the VRF indoor unit can be cycled on and off (depending on outdoor air delivery configuration—see “Ventilation Delivery” on page 45 for additional discussion). Because the DOAS offsets nearly the entire space latent load, the resulting space relative humidity level surpasses the design target of 50 percent by a smaller margin compared to “warmer” DOAS supply-air conditions.

**DOAS: 45°F supply air: Part load 0.667 SHR**

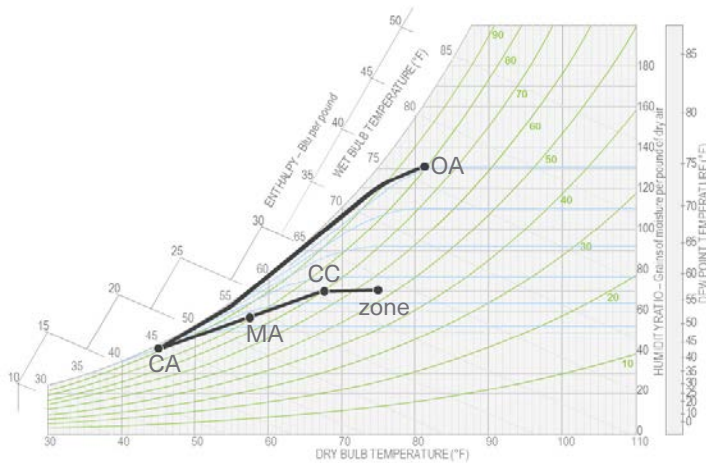

**DOAS: 45°F supply air: Part load 0.611 SHR**

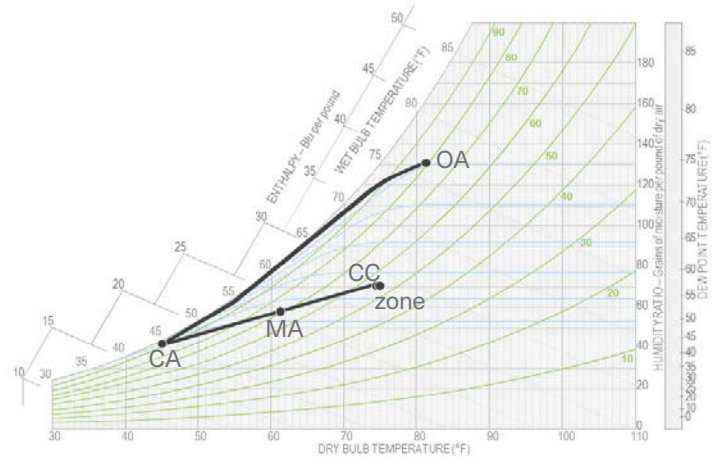

### Oversupplying ventilation air

For those zones that are experiencing high humidity, consider supplying more than the minimum ventilation required. The additional dehumidified ventilation air will offset more of the space latent load, resulting in lower space humidity levels.

# Ventilation System

Ventilation equipment is available in a wide variety of options. In most cases, equipment can be classified into one of the following categories:

- **Energy Recovery Ventilator (ERV)**
- **Dedicated Outdoor Air System (DOAS)**

There are also a wide variety of considerations for ventilation equipment, including:

**Location: indoors or outside.** Equipment may be located inside a building or outside, perhaps on the roof. The location of ventilation equipment impacts a variety of other considerations, such as:

- Equipment insulation
- Building structure design to support rooftop-mounted equipment
- Need for low ambient operating equipment in cold climates
- Condensate management systems

**Energy recovery device.** There are a variety of energy recovery devices available. Some devices are designed to only transfer sensible heat, while others transfer sensible and latent heat. Common examples include energy wheels and fixed membrane cores.

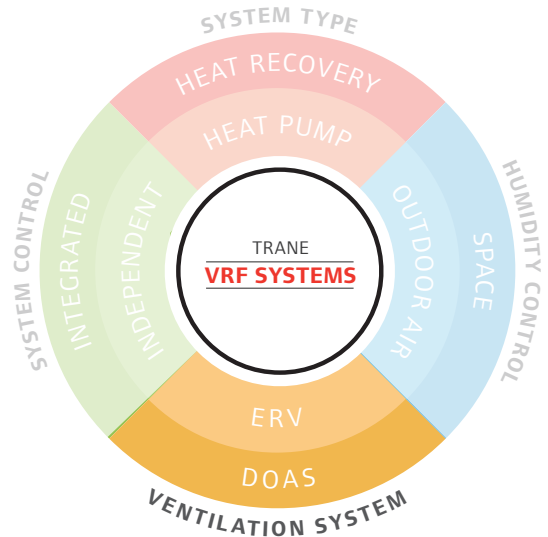

**Supplemental heat.** In cold climates, the outdoor air will likely need to be heated before distribution to the occupied zones. There are a variety of heating sources available, including heat pump, hot water, electric heat, natural gas, or steam. Energy recovery devices can also be used to pre-heat cold outdoor air using recovered heat from the exhaust air stream.

**Demand controlled ventilation (DCV).** The use of demand controlled ventilation allows the BAS to modulate the flow of ventilation air as zone population changes. If the outdoor air intake is varied throughout operation, a variable speed supply fan must be supplied. Building exhaust and pressure systems must also be designed accordingly. For more information on DCV, see page 47.

## Energy Recovery Ventilators

An energy recovery ventilator (ERV) includes an energy recovery device, a fan, and filters. An ERV provides passive treatment of the outdoor air because there is no mechanical cooling present. Some ERVs are designed to only transfer sensible heat, while others transfer sensible and latent heat. Examples include sensible-only and total-energy wheels and fixed membrane heat exchangers.

An ERV includes two distinct air paths: an exhaust air path and an outdoor air path. During the cooling season, the air-to-air heat exchanger is used to precool the outdoor air. Heat and moisture are transferred from the hot, humid outdoor air to the cooler, drier exhaust air stream. In the heating season, ERVs use the air-to-air heat exchanger to preheat the air. Heat is transferred from the warm exhaust air to the cooler outdoor air stream.

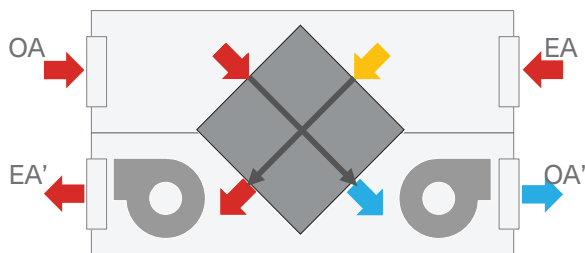

This allows the ERV to partially cool in the summer and partially heat the outdoor air in the winter. For mild weather operation, ERVs will often include an air bypass when energy recovery is not needed.

Without mechanical cooling, an ERV will not dehumidify and cooling capability is limited. Thus, an ERV is best suited for milder climates where mechanical cooling and dehumidification may not be needed.

Consider the Lossnay® model for ventilation needs up to 1200 cfm and the Performance Climate Changer® CSAA model for ventilation requirements from 1200 to over 20,000 cfm.



Model	Equipment Location	Exhaust Air Energy Recovery	Supplemental Heat	Demand-Controlled Ventilation
Lossnay®	inside	core	none	yes
CSAA	inside or outside	any	any	yes

Model	Airflow capability (CFM)	
Lossnay	1200	
CSAA	1200	20,000+

Model	Static pressure capability (in.w.g.)	
Lossnay	0.75	
CSAA		8

## Dedicated Outdoor Air Systems

A dedicated outdoor air system (DOAS) achieves active outdoor air conditioning with the addition of mechanical cooling and heating, which serve to cool, dehumidify, and heat outdoor air. This conditioned ventilation air is then supplied to the occupied spaces.

Mechanical cooling and dehumidification can be provided by a direct expansion cooling coil or chilled-water cooling coil. It's common to find a direct expansion DOAS in installations that lack a chilled water system.

Dedicated outdoor air units are designed to handle 100 percent outdoor air but some can be supplied with a recirculating air damper. This damper, used in combination with the outdoor air damper, can be used to ensure the DOAS conditions recirculated air during unoccupied or morning warm-up/cool-down modes.

DOAS units with DX coils are available as a packaged solution, or a split solution. Split systems typically install an air handler inside the building and have a connected condensing unit outside.

Packaged systems can be supplied with factory-installed refrigerant piping and hot gas reheat systems, eliminating the need for field installation. As a result, packaged DOAS units are an ideal choice for applications that require DX-recovered heat

The tables that follow include two additional columns to differentiate DOAS equipment:

### Space humidity management:

- **No:** outdoor air is dehumidified to a dew point temperature that is higher than (or equal to) the desired space dew point. In this case, space humidity can vary at part-load operation. This strategy may be used to achieve minimum compliance with codes or standards that require a maximum humidity level at design conditions.
- **Yes:** Capability exists to manage space humidity at all operating conditions, which means the outdoor air is dehumidified to a dew point temperature that is lower than the desired space dew point. With this strategy, some of the space latent loads may be offset by the ventilation system.
- **Yes with CDQ™:** Capability exists to manage space humidity below the “dew point barrier” using a Cool, Dry, Quiet (CDQ®) wheel. See sidebar, below.

### DX recovered reheat:

- **Hot gas reheat (HGRH)** or recovered heat from the terminal system. Used to heat the supply air to prevent overcooling the zone.

DOAS units containing a DX coil are available in either a packaged solution or a split solution, the latter with the option to mount the air-handling portion inside or outside of the building.

### CDQ™

The Performance Climate Changer® CSAA unit is available with an additional dehumidification capability known as Trane Cool, Dry Quiet™ or CDQ. An air handler equipped with CDQ uses a type III desiccant wheel to lower the supply air dew point temperature below the saturated dew point limit of the cooling coil. It achieves this reduction by adsorbing moisture from the air downstream of the coil, and rejecting that moisture upstream of the coil. The cooling coil still performs all the dehumidification work, with the CDQ wheel creating an opportunity to lower the dew point temperature below the supply air dew point at saturation—something known as the “dew point barrier.”

A type III desiccant wheel is separate and distinct from an energy recovery wheel. A unit that includes both an energy wheel and a CDQ wheel is known as a “dual-wheel” unit.

For more information on CDQ, see Trane brochure CDQ-SLB001-EN or *Engineers Newsletter* ADM-APN016-EN.



# Horizon™ Dedicated Outdoor Air System



The Horizon™ product line is a complete DOAS solution capable of space humidity management with optional DX-recovered reheat and optional exhaust air energy recovery. The Horizon™ product line has the airflow

and pressure capability needed to meet a variety of ventilation requirements. If additional airflow or pressure capability is needed, consider a custom DX solution or a DOAS split system.

Model	Equipment Location	Exhaust Air Energy Recovery	Supplemental Heat	Space Humidity Management	DX Recovered Reheat	Demand-Controlled Ventilation
Horizon™	outside	wheel	any (excl. steam)	yes	yes	yes

Model	Airflow capability (CFM)	
Horizon™	500	20,000

Model	Pressure capability (in.w.g.)	
Horizon™	4.00	

## Trane® Mixed Air Unit

The Mixed Air Unit product line is a DOAS solution capable of limited space humidity management. Optional DX-recovered reheat and optional exhaust air energy recovery are available. The Mixed Air Unit product line has the airflow and pressure capability to meet small and medium ventilation requirements. Consider Horizon™ DOAS, a custom DX solution, or a DOAS split system if space humidity management is required, or if greater airflow or pressure capabilities are needed.



Model	Equipment Location	Exhaust Air Energy Recovery	Supplemental Heat	Space Humidity Management	DX Recovered Reheat	Demand-Controlled Ventilation
Mixed Air Unit	outside	wheel	electric gas	no	yes	yes

Model	Airflow capability (CFM)	
Mixed Air Unit	4,000	6,000

Model	Pressure Capacity (in. w.g.)
Mixed Air Unit	electric or gas heat - 2.0 inches w.g. no heat - 4.0 inches w.g.

## Split DOAS

A split DOAS combines a wide variety of air handler options with condensing units. The use of air handlers provides numerous options for casing construction types, fan types, fan quantities to address redundancy needs, air-to-air heat recovery options, air cleaning options, acoustical options, and many more. A split DOAS may be chosen for a variety of reasons, including:

- Offers a larger variety of air handling options, including the ability to locate the AHU indoors
- Offers higher airflow and static pressure capabilities
- In some cases, DOAS and terminal units can be served by the same condensing units, enabling heat recovery between the DOAS and terminal system

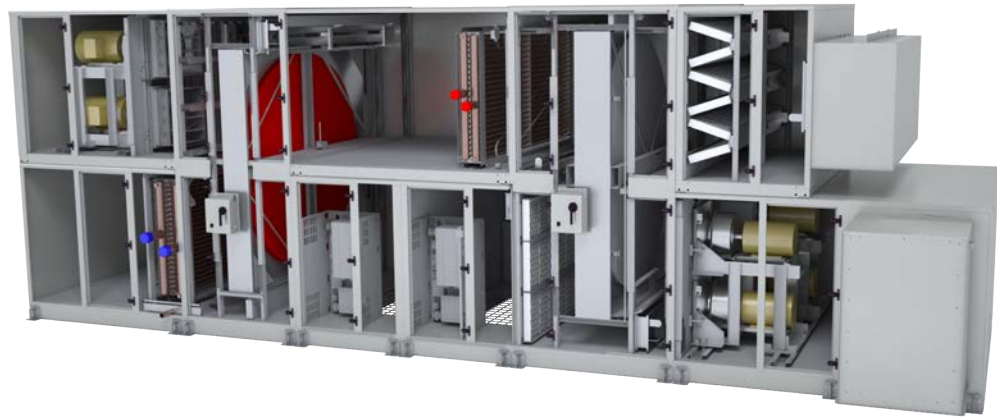

The TPEFY-OA outdoor air processing (OAP) unit is designed to handle 100% outdoor air and has the ability to operate within a limited temperature range with limited controls. The unit can integrate with other indoor units including simple integration with the native City Multi® BAS system. It is best suited for zone-level ventilation tempering when precise temperature control and space humidity management are not a priority.

The Trane Blower Coil Air Handler (BCXD) and Performance Climate Changer® models UCCA and CSAA offer increasing flexibility for a wide variety of building needs. For the most flexibility, consider a Trane custom air handler.

Model	Equipment Location	Exhaust Air Energy Recovery	Supplemental Heat	Space Humidity Management	DX Recovered Reheat	Demand-Controlled Ventilation
TPEFY-OA	inside	none	none	no	*	no
BCXD	inside	none	any (excl. gas)	no	no	yes
UCCA	inside or out	none	any (excl. gas)	yes	no	yes
CSAA	inside or out	wheel or core	any	yes + CDQ®	*	yes

\*Contact factory for recovered reheat options available on the TPEFY-OA (1200 CFM only) or CSAA product lines

Model	Airflow (CFM)	
TPEFY-OA	1200	
BCXD	2400	
UCCA	1200	15,000
CSAA	1200	20,000+

Model	Static pressure capability (in.w.g.)	
TPEFY-OA	1.00	
BCXD	2.50	
UCCA		6.00
CSAA		8.00

\*BCXD, UCCA, and CSAA products assume nominal CFM at 400 FPM

\*\*CSAA limited to 80 tons (unit size 30) in Trane Select Assist, contact factory for larger applications

Special considerations should be given when split DOAS and terminal units share common condensing units. To avoid any operating mode conflicts, the correct outdoor unit must be chosen for the application.

#### Which outdoor unit to select depending on whether the outdoor units are:

- **Dedicated for the ventilation system:** Y-series (heat pump), unless recovered reheat. Contact factory for more information.
- **Shared with the terminal system:** R2-series (heat recovery)

A split DOAS should typically use its own condensing unit primarily due to the cooling and heat capacity needed to treat the outdoor air. In smaller applications, however, the condensing unit may be shared with the terminal units. When outdoor units are shared, the load from the DOAS unit(s) may not be greater than 30 percent of the total connected system (ventilation load plus terminal load). In addition, the combination ratio is limited to 110 percent or less.

See page 64 for more information on split DOAS considerations with an LEV kit.

## Other Ventilation Options

In addition to the dedicated ventilation equipment discussed, there are a number of split, mixed-air options. In this case, the ventilation and terminal systems are the same. Equipment in this category would include fan coils or air handlers that have mixing capabilities, as well as unit ventilators.

### Unit Ventilator

Unit ventilators are commonly applied in classroom environments, but they could be an option for any building where an outside wall is available for the ventilation air opening. A unit ventilator is capable of providing airside economizing during mild weather.



## Ventilation Delivery

There are several different methods to deliver ventilation air from the dedicated outdoor air system (DOAS) to the zone occupants. These methods include delivering unconditioned outdoor air direct to the terminal unit, delivering conditioned outdoor air direct to the terminal unit, and delivering conditioned outdoor air direct to the zone. All are commonly used and have their own inherent advantages and drawbacks.

### Unconditioned Outdoor Air Direct to the Terminal Unit

In this configuration, sometimes called the “direct ventilation method,” outdoor air is ducted directly to a terminal unit. This unconditioned outdoor air mixes with return air then conditioned using the VRF terminal unit’s coil. The ventilation air is not preconditioned, and requires the VRF indoor units to offset all dehumidification, cooling, and heating loads. In addition to the indoor unit, additional filtration and duct booster fans are often required. The direct method should only be considered for dry climates, and/or applications requiring minimal ventilation air.

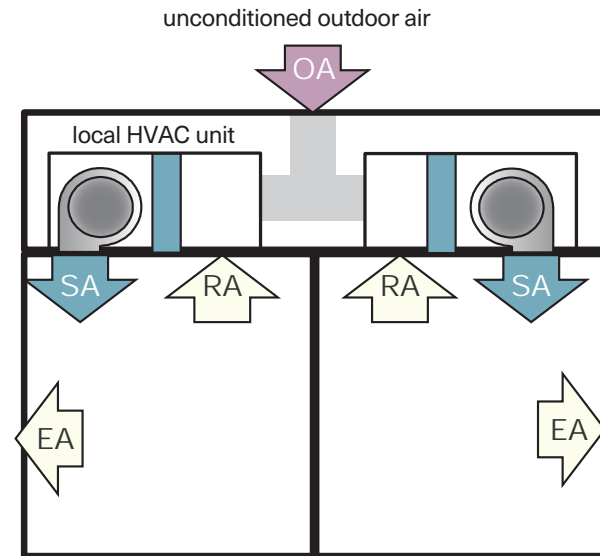

### Advantages

- Simple, inexpensive method to provide ventilation to each zone.

### Limitations

- VRF indoor units have limited dehumidification, cooling, and heating capabilities
- May require inline booster fan to ensure ventilation air delivery to indoor unit
- May require airflow modulation device (louvers, variable speed booster fan with controls) or VAV box to ensure outdoor air delivery as indoor unit fan speed changes
- Measurement and balancing is more difficult than if outdoor air delivered directly to zone
- May need to increase outdoor air quantity in heating mode ( $E_z < 1.0$ ) to comply with ASHRAE® Standard 62.1 ventilation requirements.
- Requires field-fabrication to connect outdoor air duct
- VRF terminal fan must operate continuously to provide outdoor air during scheduled occupancy

And, unlike traditional DOAS, this system minimizes fan and ventilation conditioning energy when only some zones require ventilation. A traditional dedicated outdoor air system may operate at full speed whenever the building is minimally occupied as there are no dampers to prevent ventilating unoccupied zones.

## Conditioned Outdoor Air Direct to the Terminal Unit

An alternative configuration, sometimes called the “integrated ventilation method,” delivers preconditioned and filtered outdoor air directly to the intake of each VRF indoor unit, using Lossnay energy recovery ventilator, Trane TPEFY® VRF outdoor air processing unit, Horizon® DOAS, or Performance Climate Changer® air handler.

Conditioned outdoor air is ducted directly to the return side of each VRF indoor unit where it mixes with return air and is then further conditioned by the VRF unit and discharged directly to the space. This approach is typically used when VRF terminals are installed in the ceiling plenum or in a closet near the space.

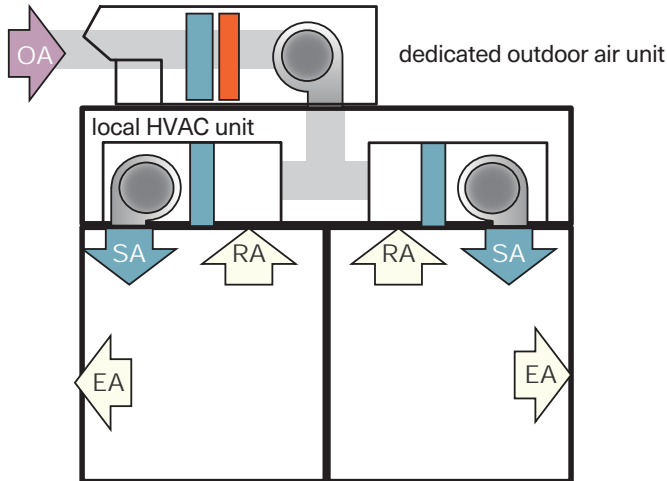

### Advantages

- Helps ensure required outdoor airflow reaches each zone (ducted directly to each VRF terminal)
- Avoids cost and space to install additional ductwork and separate diffusers
- Easier to ensure that outdoor air is adequately dispersed throughout zone because it is distributed by VRF terminal fan

### Limitations

- Measurement and balancing is more difficult than if outdoor air delivered directly to zone
- May require field-fabricated plenum to connect outdoor air duct
- May need to increase outdoor air quantity in heating mode ( $E_z < 1.0$ ) to comply with ASHRAE® Standard 62.1 ventilation requirements
- VRF terminal fan must operate continuously to provide outdoor air during scheduled occupancy
- VRF terminal fan must operate if dedicated outdoor air system operates during unoccupied period

A common rule of thumb is to size DOAS units for 55°F supply air dew-point temperature. When processing ventilation air, a psychrometric review often shows this is not always adequate and a lower dew point temperature is required. Often the required dew-point temperature may be as low as 45°F.

## Conditioned Outdoor Air Direct to the Zone

In this configuration, sometimes called the “decoupled ventilation method,” the DOAS delivers conditioned outdoor air directly to each zone through a separate air delivery system.

The VRF indoor unit only conditions recirculated air from the zone. This method provides for 100 percent conditioning of the pre-filtered ventilation air, which is dehumidified to an appropriate dew-point temperature to offset zone latent loads (see “Humidity Control: Ventilation Options,” page 24. This allows the DOAS to offset both the ventilation and zone latent needs. Further, if reheat is not used, the DOAS may offset a portion of the space sensible loads, also resulting in smaller VRF components.

## Advantages

- Easier to ensure code/standard-required outdoor airflow reaches each zone (separate diffusers)
- Opportunity to cycle VRF terminal fan because outdoor air is not distributed through it
- Allows dedicated outdoor air system to operate during unoccupied periods without needing to operate VRF terminal fans
- Opportunity to downsize local equipment (if outdoor air delivered at a cold temperature)

## Limitations

- Requires installation of additional ductwork and separate diffusers
- May require multiple diffusers to ensure that outdoor air is adequately dispersed throughout the zone

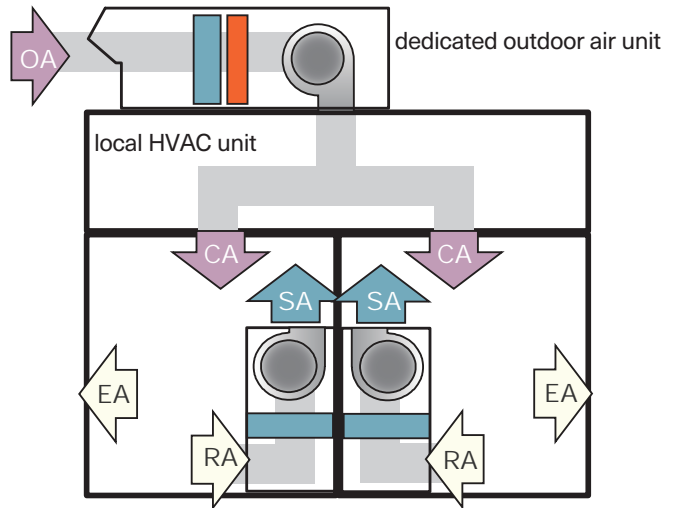

## Demand Controlled Ventilation

ASHRAE® Standard 62.1 allows designers to reset the intake airflow in response to variations in zone population, called demand controlled ventilation (DCV). This allows the HVAC system to respond to actual need, or demand” for ventilation by adjusting the outdoor air intake rate. As a result, DCV can be used to reduce operational costs at times when building occupancy is less than design.

To provide demand controlled ventilation, pressure independent dampers (such as VAV terminal units with airflow measurement) may be used. The VAV boxes are placed within the ventilation ductwork to ensure each zone receives the correct amount of outdoor air. Fan pressure optimization, a control scheme that resets the DOAS supply fan pressure based on the position of these VAV dampers, may also be employed to reduce DOAS fan energy consumption.

There are several methods to determine ventilation demand, including:

- **Occupancy schedules.** Use occupancy schedules to specify the current population for a given zone based upon time of the day within the building automation system.
- **Occupancy sensors.** Sensors which detect the presence of people and can (optionally) count the number of occupants in the zone at a given time.
- **Carbon dioxide (CO<sub>2</sub>) sensors.** Sensors which monitor the concentration of CO<sub>2</sub> continuously produced by zone occupants and diluted by the outdoor air.

To provide DCV, the ventilation system must be capable of modulating the quantity of ventilation delivered to each zone.

A pressure-independent VAV damper might be used to regulate the flow of outdoor air.

The DOAS must be equipped with a variable speed fan and controller to maintain a duct static pressure setpoint. This allows the DOAS to pressurize the ventilation duct system and each pressure-independent VAV box modulates its VAV damper to deliver the correct amount of outdoor air, based upon current space demand.

In a VRF system equipped with a DOAS, delivering a fixed (constant) quantity of outdoor air may be desired because the ventilation air serves two purposes: providing outdoor air to dilute contaminants and providing dehumidified air to maintain zone humidity. In this case, the DCV sequence can be overridden (increasing the flow rate of cool, dehumidified air) if additional dehumidification is needed.

# System Control

Trane Variable Refrigerant Flow systems include several options to ensure proper system control:

- **Independent system control** - Uses dedicated VRF controls to manage only the VRF system. This is a pre-engineered, easy-to-install solution, that includes wall-mounted controllers, indoor and outdoor unit controls, branch controllers, and central controller options.
- **Integrated system control** - Integrates the VRF controls into a higher-level BAS system. This can provide coordination with ventilation systems and other HVAC or building systems. It can also provide additional features including graphical user interfaces, advanced control strategies, monitoring, data collection, remote access, and tenant services.

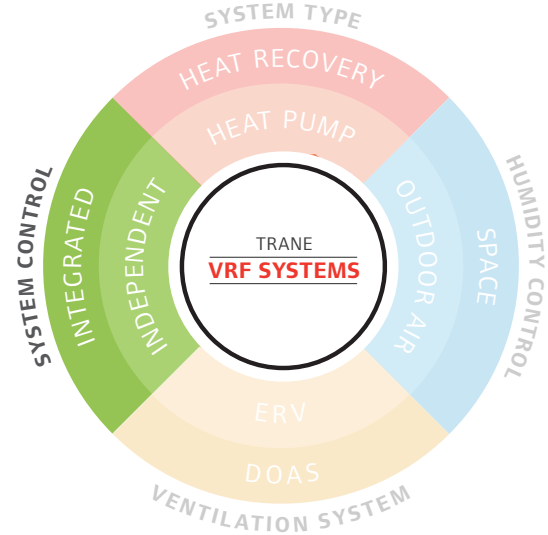

## System-Level Control

### Independent System Control (No Building Automation System Installed)

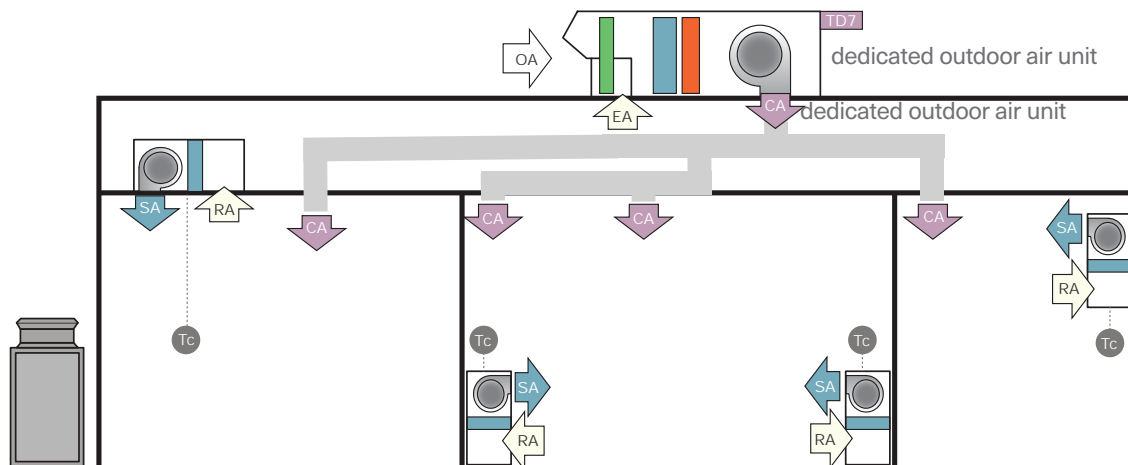

Each zone has a Terminal controller (Tc), see Terminal Controller Options for more details, with several control options:

- User-set heating and cooling setpoints
- Automatic control with single or dual setpoint control

When enabled, the built-in occupancy sensor detects vacancy in a specific zone. When vacant, the controller will use setback setpoints to reduce energy consumption.

A dedicated outdoor air unit provides conditioned outdoor air to each zone when occupied. Building occupancy may be determined by schedule, which must be programmed through a Tracer® TD7 display. Alternatively, the DOAS unit accepts a binary signal to indicate occupancy from a remote signal or closed switch. Modes of operation (heat/cool/dehumidification/ventilation only) are determined by ambient conditions. Each mode of operation has a separate discharge temperature setpoint set through the Tracer TD7 display at start-up.



## Independent System Control with Demand-Controlled Ventilation

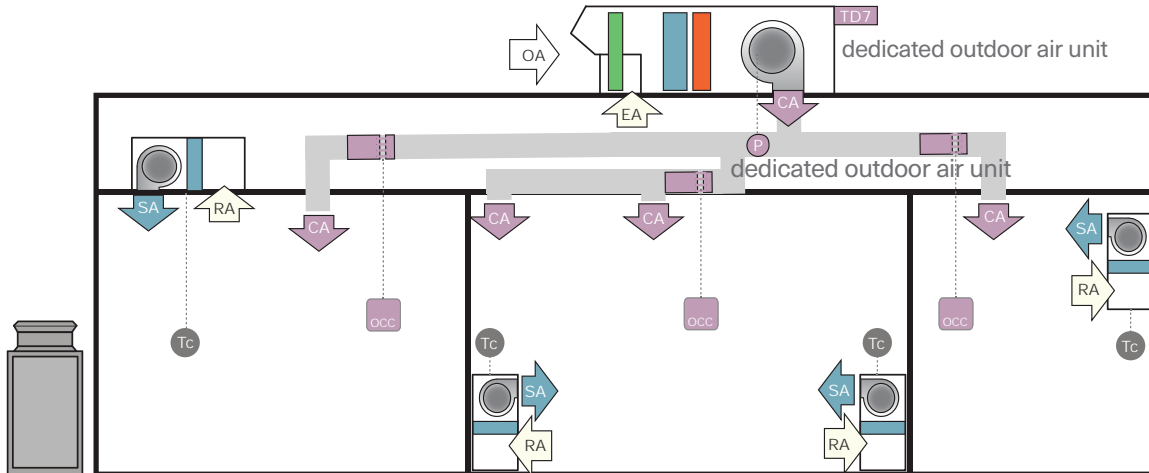

Each zone has a Terminal controller (Tc), see Terminal Controller Options for more details, with several control options:

- User-set heating and cooling setpoints
- Automatic control with single or dual setpoint control

When enabled, the built-in occupancy sensor detects vacancy in a specific zone. When vacant, the controller will use setback setpoints to reduce energy consumption.

A DOAS pressurizes supply ductwork to a static pressure setpoint and provides conditioned outdoor air to each zone when occupied. Building occupancy may be determined by schedule, which must be programmed through a Tracer® TD7 display. Alternatively, the DOAS unit accepts a binary signal to indicate occupancy from a remote signal or closed switch. Modes of operation (heat, cool, dehumidification, ventilation only) are determined by outdoor ambient conditions. Each mode of operation has a separate discharge temperature setpoint provided at start-up.

Zones have independent air valves with wired occupancy sensors. Ventilation is provided based upon the outdoor airflow setpoint for the zone when the DOAS time of day schedule is set to occupied. When a zone is unoccupied, the air valve is reset to its minimum position.

**Integrated System Control for Small Applications (Tracer® Concierge®)**

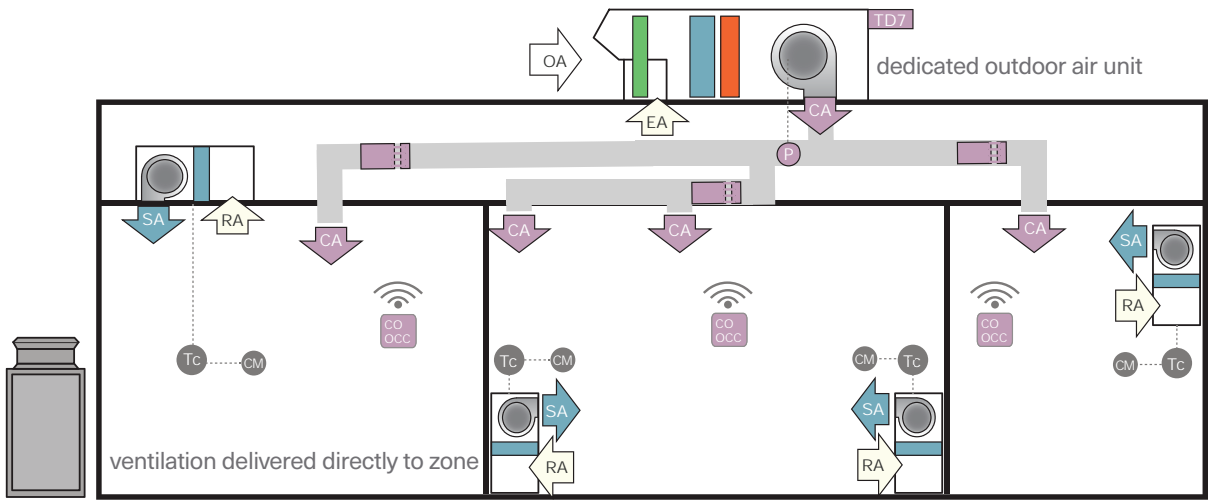

Each zone has a Terminal controller (Tc), see Terminal Controller Options for more details, with several control options:

- User-set heating and cooling setpoints
- Automatic control with single or dual setpoint control

When enabled, the built-in occupancy sensor detects vacancy in a specific zone. When vacant, the controller will use setback setpoints to reduce energy consumption.

A DOAS pressurizes supply ductwork to a static pressure setpoint and provides conditioned outdoor air to each zone when occupied. Building occupancy and scheduling information is determined by the BAS (Tracer® Concierge®). Modes of operation (heat, cool, dehumidification, ventilation only) are determined by outdoor ambient conditions. Each mode of operation has a separate discharge temperature setpoint that can be reset by the BAS. The BAS determines when to reset setpoints based upon zone demands.

Zones use independent air valves with a wired or wireless Air-Fi® CO<sub>2</sub> and occupancy sensor. The outdoor airflow setpoint to the zone is reset based upon measured zone CO<sub>2</sub> when the zone is occupied and building is in occupied mode. When the building is occupied and the zone is unoccupied, the air valve is reset to its minimum position.

The Tracer® Concierge® BAS communicates directly with the UC600-equipped DOAS and UC210-equipped DOAS terminal boxes using MS/TP or wireless Air-Fi® communication.

For small applications, a Tracer® Concierge® can communicate to VRF terminal units, with each terminal unit requiring a Procon Module (CM)\*. Space temperature, setpoint and occupancy are all communicated. The BAS can command the unit on or off, and can set the zone temperature setpoint.

\*Optionally, smaller buildings can use an M-Net compatible central controller to communicate to the BAS. This is in lieu of each terminal having a Procon Module.

*BAS  
Trane Tracer® Concierge®  
Controller with mobile access  
(wired or wireless Air-Fi®)*



## Integrated System Control for Large Applications (Tracer® SC+)

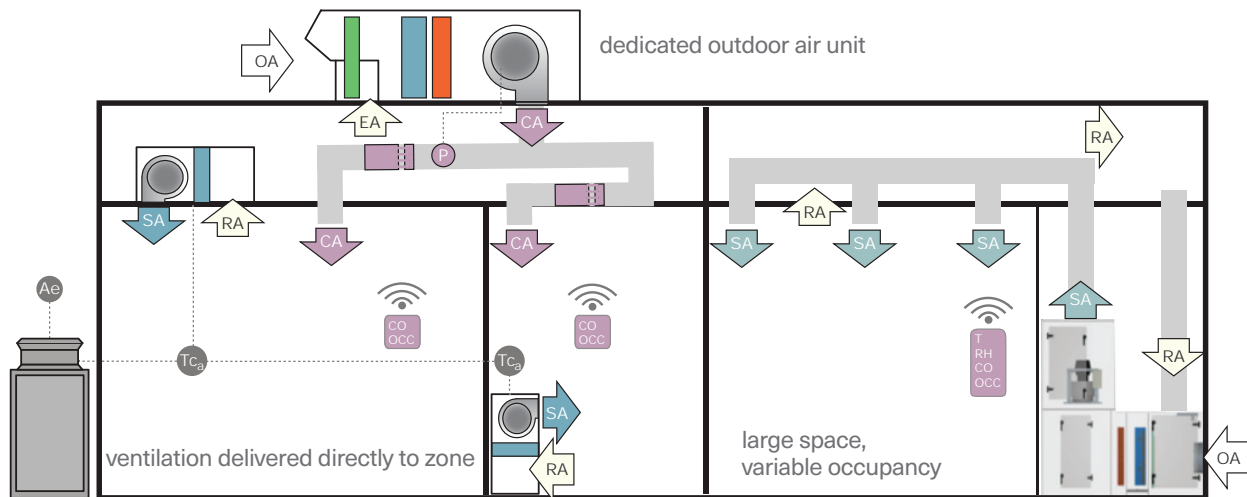

A large application may have a variety of different system types. For example, a building might utilize separate terminal and ventilation system for most zones while using a single-zone VAV (SZVAV) air handler to maintain a large space with variable occupancy, such as a cafeteria or lecture hall. In the example shown, the AHU is paired with a VRF heat pump condensing unit and an LEV kit. A BAS can be used to coordinate all systems in the building.

The SZVAV AHU uses field-programmed controllers that utilize logic from Trane pre-packaged solutions. The Tracer® SC+ BAS communicates directly with the UC600-equipped AHU and UC210-equipped DOAS terminal boxes using MS/TP or wireless Air-Fi® communication. Zone temperatures are determined and communicated with wired or wireless Air-Fi® zone sensors.

Each zone with an indoor unit has a Terminal controller (Tca), see Terminal Controller Options for more details, and the terminal units are daisy-chained back to the outdoor unit(s). Central controllers are required. Each central controller communicates to the Tracer SC+. The terminals receive their independent setpoints and scheduling information from the Tracer SC+.

One or more dedicated outdoor air systems pressurize supply ductwork to a static pressure setpoint and provide conditioned outdoor air to each zone when occupied. Building occupancy and scheduling information is determined by the BAS (Tracer SC+). Modes of operation (heat, cool, dehumidification, ventilation only) are determined by outdoor ambient conditions. Each mode of operation has a separate discharge temperature setpoint that can be reset by the BAS. The BAS determines when to reset setpoints based upon zone demands.

Zones use independent air valves with a wired or wireless Air-Fi® CO<sub>2</sub> and occupancy sensor. The outdoor airflow setpoint to the zone is reset based upon measured zone CO<sub>2</sub> when the zone is occupied and the building is in occupied mode. When the building occupied and the zone is unoccupied, the air valve is reset to its minimum position.

### Additional HVAC Optimization Strategies

Conference rooms and other high occupancy spaces can have high humidity levels when occupied. See page 30, “Psychrometric Analyses” for an example.) One way to reduce peak humidity levels in these zones is to implement BAS logic that enables dehumidification overrides when necessary. Trane has several methods to implement humidity control for these zones. The zone DOAS airflow can be reset upward or the DOAS dew point can be reset downward based on space humidity.

Morning warm-up for the zones can be supplemented by using the DOAS unit. Before occupancy, the DOAS unit will operate in recirculation mode and raise space temperature of the zones.

Implementing fan pressure optimization can save additional dedicated outdoor air system fan energy.



### Additional BAS System Options

The Tracer Concierge and Tracer SC+ BAS controllers can operate standalone or can be part of a Tracer Ensemble (or other) building management system (BMS). These BAS controllers can also be used with Trane Connect for remote access and a variety of cloud-based services. Refer to Trane Building Automation System and Enterprise Solutions on page 53 for more information.

## Terminal Controller Options

### Simple MA (TAC-YT53CRAU-J)



The Simple MA is a low-cost solution to provide indoor unit control to the occupant. It is intended for manual control of the equipment and does not support a local scheduling feature. The indoor unit can be controlled via a schedule residing in a central controller or a BAS.

### Backlit MA (TAR-40MAAU)



The Backlit MA remote controller has a large backlit LCD with full and basic display modes. It supports P-Series rotation (requires PAC-SF83MA-E adapter), advanced cassette operations, 3D i-See sensor functions, and daylight

savings time. The remote controller also supports a daily and weekly schedule functions.

### Touch MA (TAR-CT01MAU-SB)



The Touch MA is a full color touchscreen remote controller with Bluetooth® support, which enables occupant and contractor access with smartphones to control and configure the unit including scheduling functions. The Touch MA has a large

selection of background colors and information display options that allow the device to be customized for any environment. The device can also display a custom logo image and supports multiple languages.

The features of this device make it ideal for use in the hospitality industry.

### Smart ME (TAR-U01MEDU-K)



The Smart ME controller is a remote controller designed to control Trane®/Mitsubishi Electric air conditioning units.

The Smart ME controller features functionality for basic operation and monitoring of air conditioning units including schedule. The controller includes four built-in sensors (temperature, humidity, occupancy, brightness).

The built-in occupancy sensor detects vacancy in a specific zone enabling the controller to use its internal function to reduce energy-consumption (when enabled).

## Central Controller Options

### TW-50



The TW-50 is the entry-level into the centralized controller and can network up to 50 indoor units. It can be connected via Ethernet or IP to a BAS (which requires a license). It does not have a display and requires the

initial setting tool to setup. It is very versatile and can be used as an expansion of a site with a TE-200, standalone without the TE-200, or as part of an apportionment site with a TE-200 which is not utilizing the M-Net (the protocol used to communicate within the terminal system) link.

BACnet Interface for 3rd party BAS.

## TE-200

The TE-200 is the most capable of the centralized controllers in that it is required to enable features such as apportionment and tenant billing. It also comes with a display and is able to support connection to a BAS (requires a license).



BACnet Interface for 3rd party BAS.

## TE-50

The TE-50 is used to network up to 50 indoor units as an expansion of a site with a TE-200. However, it cannot be used for standalone applications. It does include a display for site requiring multiple displays (TE-200 also includes a display). It can be connected via BACnet® (LAN2) to a BAS (requires a license).

BACnet Interface for 3rd party BAS.

## Trane Building Automation System and Enterprise Solutions

### Tracer® SC+

The Tracer SC+ enables additional capabilities with an extensive data and equipment list including the outdoor units and branch controllers which are only available with the Trane® / Mitsubishi Electric VRF system.



In addition, this enables advanced capabilities such as system level applications to control both the LEV kit and other equipment. This additional capability expands the systems capability to mixed use application where VRF can now be included with traditional HVAC equipment such as Air Handling Units, Dedicated Outdoor Air Units, Rooftop Units, and even Variable Air Volume boxes. Tracer SC+ can integration the VRF, traditional HVAC, lighting, and other systems to provide complete building solutions with full coordination with a single user interface for the building.

## Tracer Concierge Systems

Concierge Systems bring a building automation system (BAS) to customers who previously avoided a BAS due to its complexity and cost. Concierge Systems allow contractors to install a BAS on light commercial projects with Trane® / Mitsubishi Electric VRF equipment. In addition, building operators get a simple interface to the VRF equipment and additional HVAC, lighting, and ancillary systems in the building.

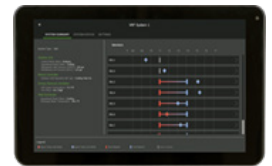

## Air-Fi Wireless Sensors

Air-Fi Wireless Sensors for VRF help ensure projects remain on schedule with the added flexibility of placement and installation after the walls are installed. No more delays waiting for wire to go into the wall or delays related to relocating a sensor. In addition, Air-Fi Wireless Sensors measures temperature with optional humidity, occupancy, and CO<sub>2</sub> levels on a single sensor. These sensors can be mounted on most surfaces including cement block or masonry walls reducing labor to install sensors in such buildings.



## Tracer® Ensemble® and Tracer® Ensemble Cloud

Tracer Ensemble is a web-based building management system (BMS) that dramatically simplifies the complex requirements of managing and operating large facilities and/or multiple facilities. Accessible from most PCs, tablets, and smartphones, Tracer Ensemble provides immediate access to your building systems from virtually any location, allowing you to maintain comfortable, healthy conditions and satisfied occupants.

Tracer Ensemble uses Windows® Server technology to provide scalability and long-term data storage and reporting. It can be installed and operated on a customer server (or virtual server) or Tracer Ensemble Cloud is hosted by Trane, eliminating the need for customer server infrastructure and maintenance.

## Tracer Ensemble Work Order Management

Work Order Management is an optional feature of Tracer Ensemble that allows building operators to manage tenant service requests and other maintenance tasks. It is fully integrated with Tracer Ensemble, making it easy to use and automatically gathers information from connected devices. When combined with Tenant Services, it provides a full-service complement of tenant interface and building management capabilities.

## Trane Connect™

Trane provides its Tracer® customers secure remote access through Trane Connect.

Connect customers are provided access from virtually anywhere in the world with customer provided internet access and proper credentials. Trane Connect supports access from web browsers on PCs, tablets and phones as well as from Trane mobile apps on tablets or phones.

### Tenant Services

Tenant Services, a Trane cloud-based service, offers building owners the ability to tie tenant requests for their HVAC operation directly to their building control system. These requests can be made 24 hours a day and allow the building owner to manage the billing of the tenant for these requests. The building owner may setup hours of normal operation the tenant included in the lease, so tenants are not charge erroneously.

Tenant Services also includes the ability to add metering and submetering for applications such as multi-tenant where the building owner may need to account for usage on equipment serving multiple tenants. This will involve a meter on the condensing unit and sub-metering on the indoor units.

In addition, new features such as Maintenance and Work Order Management allow the tenants and building owners communicate more effectively work orders. Tenants can report maintenance issues such as a thermostat or light which is not working via a work order and the building owner can assign the work order to their staff or a contractor. This feature is easy to setup as all the equipment is automatically loaded and can be referenced in the work order.

Tenant Services is easy to setup and puts the building owner in control of the how the tenants are billed while providing the ability to review and adjust billings as necessary. With an ease to use mobile friendly interface tenants are easily able to manage their space. Tenant Service ease of setup, built-in billing, tenant interface, and after-hours management and audit trail makes it easy for the tenant and building owner to manage a space or building.

# Intelligent Services

Intelligent services are agreements for service which include a baseline of the building coupled with continuous monitoring and analytics to help optimize the performance of the building. These agreements are custom to the customer's needs. Intelligent service can help you ensure maximum comfort, energy savings, and equipment reliability throughout the life of the building. Intelligent Services is for those serious about conserving energy while still providing comfort and saving on expensive repairs with a proactive approach to building health.

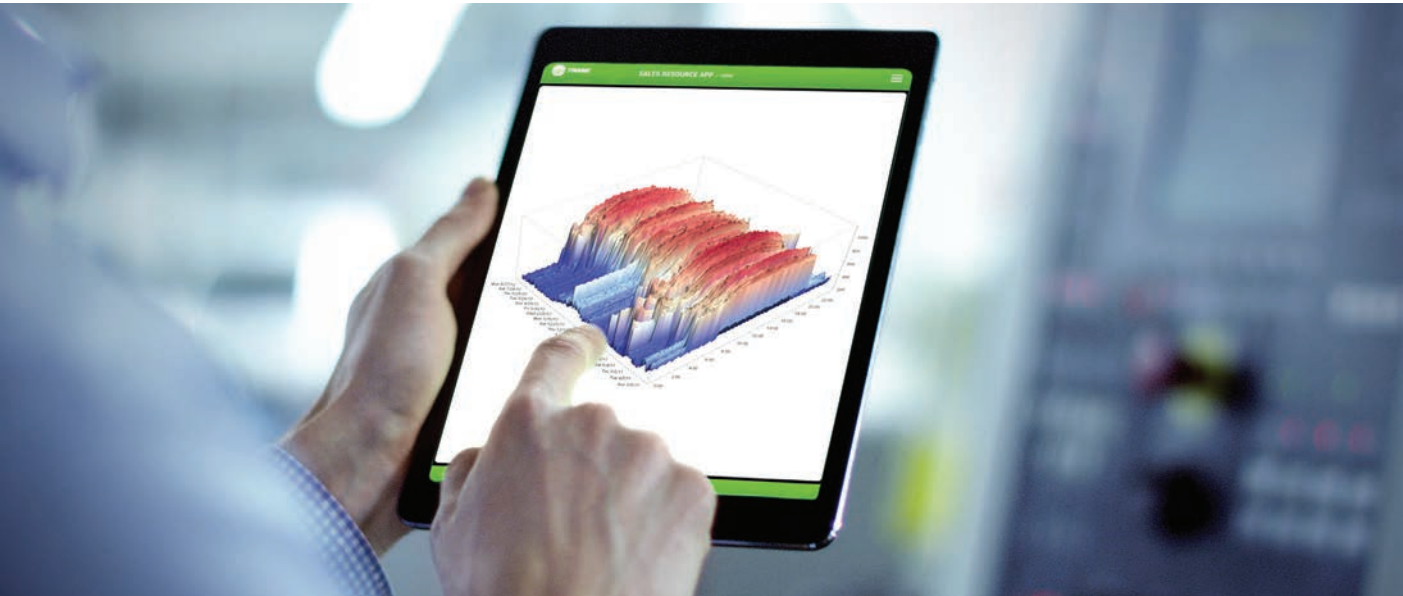

## Energy Analysis

The whole-building analysis software program TRACE® 3D Plus was used to evaluate the energy use and dehumidification performance of an air-source VRF heat recovery system with several dedicated outdoor air system (DOAS) configurations for a three story, 50,000 ft<sup>2</sup> office building. The building was modeled with one VRF system per floor to enable heat recovery between the interior and perimeter zones. Conditioned outdoor air is being delivered directly to the occupied spaces by the DOAS. Several DOAS configurations were evaluated, including the use of air-to-air energy recovery, hot gas reheat, demand controlled ventilation, and low discharge dew point temperature control. See the table below for a summary. Various DOAS options were evaluated to include with and without air-to-air total energy recovery, with and without hot gas reheat, with and without demand control ventilation and with space neutral (54°F) and low (50°F and 45°F) discharge dew point temperature control. The modeled DOAS options are shown in the table below.

The modeling was performed for cities in a variety of climate zones. They were:

- Houston, TX – Climate Zone 2A
- St. Louis, MO – Climate Zone 4A
- Chicago, IL – Climate Zone 5A
- Los Angeles, CA – Climate Zone 3B
- Seattle, WA – Climate Zone 4C

The building shell meets ASHRAE® Standard 90.1-2013 minimum requirements and the building ventilation rates meet ASHRAE 62.1-2013 requirements. The DOAS uses a packaged unit with direct expansion cooling and gas heating capability. All reheat is provided by recovered heat rejected by the refrigeration system. Air-to-air energy recovery is accomplished using a total energy device. The line graphs that follow is a report of site energy use for HVAC electricity and natural gas reported in kBtus.

### Dedicated Outdoor Air System Description

Option	Run Name	Air-to-air energy recovery	Mechanical Dehumidification	Mechanical Cooling	Hot Gas Reheat
1	ERV Only (baseline)	Fixed Membrane	None	None	None
2	DOAS with reheat	None	54°F dewpoint	65°F dry bulb	65°F dry bulb
3	DOAS without reheat	None	54°F dewpoint	65°F dry bulb	None, cold air delivery
4	DOAS + ERV with reheat	Enthalpy Wheel	54°F dewpoint	65°F dry bulb	65°F dry bulb
5	DOAS + ERV without reheat	Enthalpy Wheel	54°F dewpoint	65°F dry bulb	None, cold air delivery
6	DOAS + ERV + DCV without reheat	Enthalpy Wheel	54°F dewpoint	65°F dry bulb	None, cold air delivery
7	DOAS + ERV + DCV 50°F DPT with reheat	Enthalpy Wheel	50°F dewpoint	65°F dry bulb	55°F dry bulb
8	DOAS + ERV + DCV 45°F DPT with reheat	Enthalpy Wheel	45°F dewpoint	65°F dry bulb	55°F dry bulb

Note: Cells highlighted in yellow represent changes from the immediately preceding DOAS.



**Key Assumptions:**

- VRF outdoor unit AHRI 1290 full load rated performance is 11.5 EER cooling, 3.41 COP heating. TRACE® 3D Plus adjusts operating performance to align with hourly operating conditions.
- VRF zone terminal unit fan ESP is 0.0 in. w.g. because cassette zone terminal units are ductless.
- DOAS full load EER @AHRI 920 rated conditions is 12.1 EER.
- DOAS fan ESP is 1.5 in. w.g.
- Gas heat efficiency is 81 percent
- Full load fixed membrane efficiency @AHRI 1060 rating conditions: 67 percent sensible, 40 percent latent
- Full load total energy wheel efficiency @AHRI 1060 conditions: 67 percent sensible, 63 percent latent

	Gas Heating	Demand Control Ventilation	DOAS Description
	None	None	Energy recovery only (does not meet the AHRI definition of DOAS).
	65°F dry bulb	None	Dehumidify and reheat when outdoor air dewpoint is above 54°F, otherwise cooling or heating to 65°F.
	65°F dry bulb	None	Dehumidify when outdoor air dewpoint is above 54°F (deliver cool air to occupied space), otherwise cooling or heating (no reheat) to 65°F.
	65°F dry bulb	None	Precondition outdoor air with enthalpy wheel then dehumidify and reheat when outdoor air dewpoint is above 54°F, otherwise cooling or heating to 65°F.
	65°F dry bulb	None	Precondition outdoor air with enthalpy wheel then dehumidify when outdoor air dewpoint is above 54°F (deliver cool air to occupied space), otherwise cooling or heating (no reheat) to 65°F.
	65°F dry bulb	Yes	Precondition outdoor air (reduced due to DCV) with enthalpy wheel then dehumidify when outdoor air dewpoint is above 54°F (deliver cool air to occupied space), otherwise cooling or heating (no reheat) to 65°F.
	65°F dry bulb	Yes	Precondition outdoor air (reduced due to DCV) with enthalpy wheel then dehumidify and reheat to 55°F when outdoor air dewpoint above 50°F, otherwise cooling or heating to 65°F.
	65°F dry bulb	Yes	Precondition outdoor air (reduced due to DCV) with enthalpy wheel then dehumidify and reheat to 55°F when outdoor air dewpoint above 45°F, otherwise cooling or heating to 65°F.

## Energy Use Discussion

The base case of ERV only (option 1) has the outdoor air treated by a fixed membrane air-to-air energy recovery device only. No active cooling and heating control of the outdoor air is included. This system option is simple to operate and delivers low annualized HVAC energy use.

DOAS with reheat (option 2) cools/dehumidifies the outdoor air to 55°F dry bulb temperature resulting in a 54°F dew point temperature condition and reheats the outdoor air to 65°F dry bulb temperature. <sup>a</sup> This modeled option delivers the highest annualized HVAC energy use for all cities other than Los Angeles. The mild Los Angeles climate negates the value of air-to-air energy recovery allowing this option to offer lower energy than an ERV only

DOAS without reheat (option 3) eliminates hot gas reheat compared to DOAS with reheat thus delivering dehumidified air at 55°F dry bulb temperature to the space. Hot gas reheat at the DOAS can result in zone level re-cooling depending on the sensible load profile in the space and the amount of DOAS reheat. Even though zone re-cooling was limited in the DOAS with reheat by limiting ventilation system reheat to 65°F dry bulb temperature, the warmer climate cities showed cooling and fan energy savings (no reheat coil pressure drop) while the cooler climate cities of Chicago and Seattle had narrow or no savings. <sup>b</sup>

An enthalpy wheel is added to a DOAS with reheat to create a DOAS + ERV with reheat (option 4) alternative. The air-to-air energy recovery technology reduces the energy to both heat and cool the outdoor air. Air-to-air energy recovery is particularly effective at reducing heating energy use due to large temperature differences between the indoors and outdoors. The energy penalty associated with increased fan pressure drop of the enthalpy wheel offsets some of the energy savings. The annualized energy use for Los Angeles actually increases with the addition of air-to-air energy recovery because its weather is so mild it cannot overcome the energy penalty of the enthalpy wheel. <sup>c</sup>

### Chicago

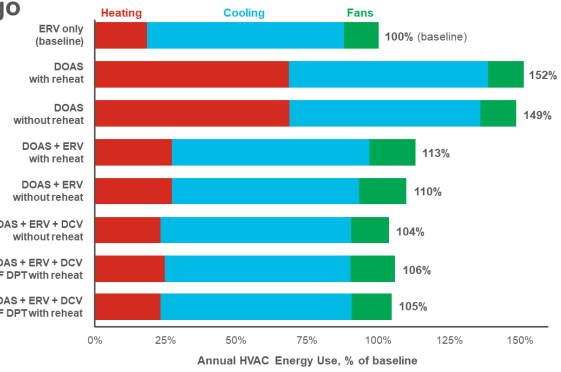

### Houston

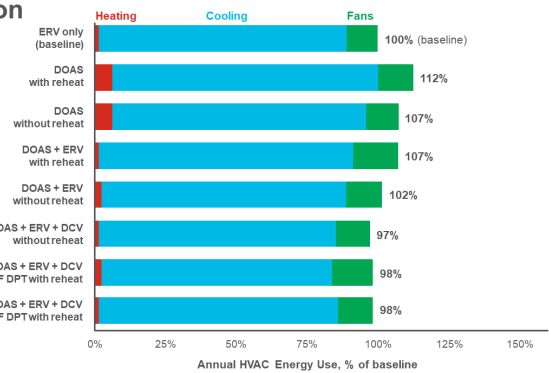

### Los Angeles

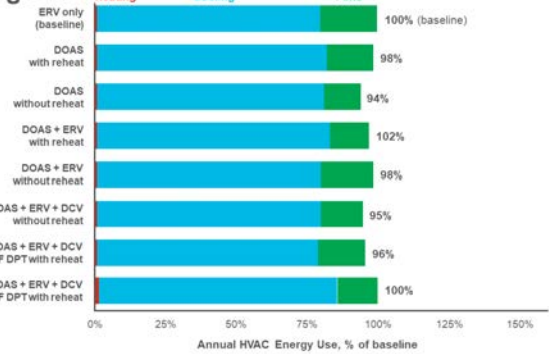

### Seattle

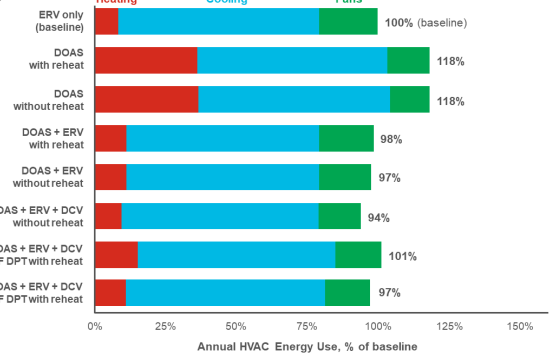

### St. Louis

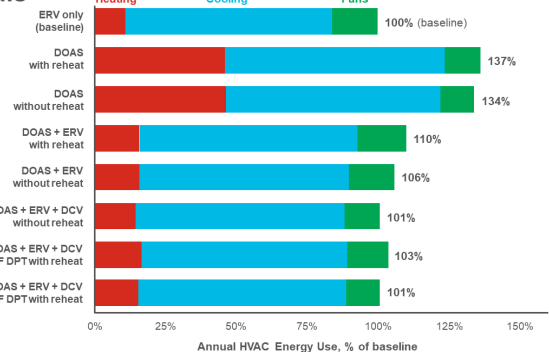

The DOAS + ERV without reheat (option 5) eliminates hot gas reheat compared to the DOAS + ERV with reheat (option 4) alternative. This comparison reveals the same recooling penalty observed when option 3 and option 2 are compared.

DOAS + ERV + DCV without reheat (option 6) adds zone level demand control ventilation (DCV) to option 5. DCV requires the addition of variable air volume terminals at each zone to allow independent ventilation airflow control based on occupancy in each zone. For this model DCV was applied to break rooms, conference rooms and large meeting rooms which are those zones that expect significant hourly variation in occupancy. The DCV option 6 compared to option 5 delivered a 3 to 6 percent HVAC energy savings favoring the type A climate zones. Much of the savings comes from the fan energy reduction of moving less DOAS air. The high enthalpy wheel effectiveness limits the heating and cooling energy reduction. <sup>d</sup>

A low supply air dew point temperature DOAS options 7 and 8 are compared to option 6 which shares all other system features with these low dew point temperature alternatives. The purpose of modeling these options is to understand the impact on building energy use when addressing occupant comfort measured in the form of reduced space relative humidity. Space humidity control is discussed in the Cooling Season Humidity Management section. This design approach shifts space dehumidification load to the DOAS and away from the VRF terminal units. This allows a variable evaporator temperature (VET) energy saving control strategy (automatic reset) to be used by the VRF system. The impact of VET is included in this model. The results are mixed, generally showing a minor increase in percent energy use compared to option 6 for higher cooling intensity cities like Houston and St. Louis and a slightly larger increase in percent energy use for the lower cooling intensity cities of Chicago, Seattle and Los Angeles. Their absolute level of cooling energy use is lower resulting in the higher percentage change.

Footnotes:

<sup>a</sup> Section 6.5.2.6 of ASHRAE 90.1-2016 limits ventilation system reheat for this application to 60°F when representative building loads or outdoor air temperature indicate the majority of zones require cooling. Since TRACE 3D Plus cannot yet model reset of the reheat temperature based on this criteria, this model limits reheat to 65°F to reduce the occurrence of re-cooling at the zone and limits winter heating to 65°F to allow shifting heating load to the heat pump VRF heat recovery system.

<sup>b</sup> The ASHRAE Achieving Zero Energy Advanced Energy Design Guide for Small to Medium Office Buildings recommends no DOAS reheat.

<sup>c</sup> ASHRAE 90.1-2013 does not require air-to-air energy recovery for both Seattle and Los Angeles

<sup>d</sup> ASHRAE 90.1-2013 requires DCV be applied in high occupant density spaces.

## Cooling Season Humidity Management

Most zone terminal units (e.g. chilled water fan coils, WSHPs, VRF indoor units) provide sensible (i.e. dry-bulb temperature) control of the zones. Any zone latent cooling (dehumidification) they provide is a coincidence of the zone sensible load, terminal unit fan speed control, and terminal unit size. Part load operation disproportionately reduces the coincidental latent cooling capacity compared to the sensible cooling capacity of these zone terminal units. So the DOAS design and operation plays a vital role in zone humidity management of any zone terminal system.

Providing outdoor air treatment with an air-to-air total energy recovery device (ERV only) provides passive dehumidification of the outdoor air. If the outdoor air is delivered to the space when humidity levels are elevated outdoors, its supply air dew point temperature will be higher than the space air thus adding latent load in the zones it serves. Assuming 75°F/50 percent RH is the desired space condition, operating a DOAS to deliver 54°F dew point supply air temperature (i.e. a result of 55°F dry bulb temperature control) causes it to deliver outdoor air at the space dew point temperature target. Since the space relative humidity varies based on actual zone load conditions, the DOAS supply air may or may not provide zone latent cooling at any particular operating hour. Operating a DOAS to deliver “low” dew point temperature air (e.g. 50°F or 45°F) causes it to provide latent cooling in the zones at more operating hours thus contributing to lower zone relative humidity levels.

The graphs to the right illustrate the difference in zone relative humidity on a hot August day versus a cooler April day in Houston, Texas in an open office comparing various DOAS dew point temperature control options. The ERV only option does not maintain zone relative humidity in a comfortable range. The 54°F dew point temperature control options offer improved zone relative humidity performance but tend to maintain it in a moderately high relative humidity range. The low dew point temperature options further improve zone relative humidity performance and tends to maintain it in a comfortable range.

## Zone relative humidity (August day)

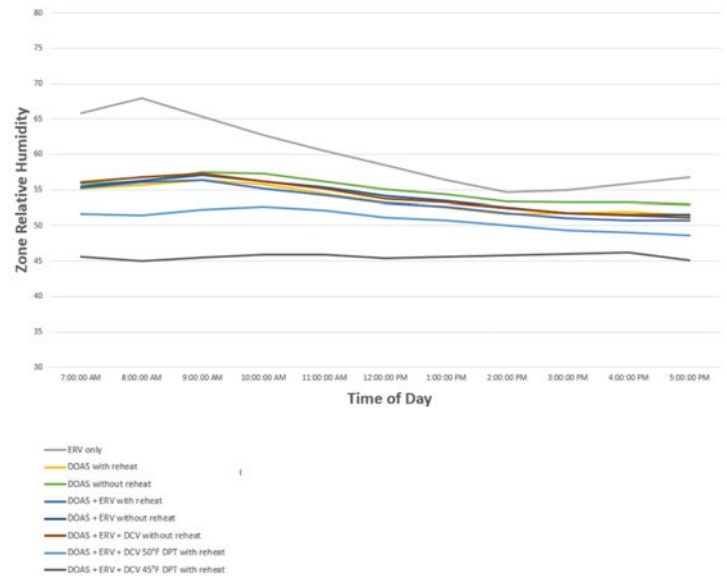

## Zone relative humidity (April day)

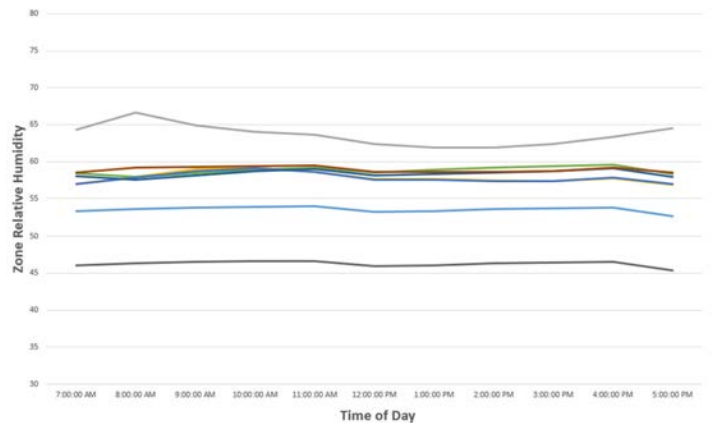

This type of performance is summarized in the graphs to the right with the number of cooling season (May through September), occupied hours (7 am to 5 pm) above 50 percent, 55 percent, and 60 percent relative humidity for a corner office space in this modeled building. This summary is intended to demonstrate and explain expected trends from system design choices, not predict the performance of any particular building.

The ERV only option resulted in a large number of cooling season occupied hours above 50 percent, 55 percent, and 60 percent relative humidity in all five cities with Seattle as an exception experiencing noticeably fewer hours above 60 percent relative humidity. The ERV is a passive device that is unable to deliver the outdoor air to the space below the space dew point temperature target (usually around 55°F dew point temperature) when outdoor air dew point temperature is high. Seattle has a large number of hours with lower outdoor air dew point temperatures resulting in fewer high zone relative humidity hours. When the outdoor air dew point temperature is high, the ERV conditioned outdoor air actually adds latent load to the zones. The zone terminal units are unable to adequately dehumidify without substantial zone sensible loads. Perhaps unexpectedly, the Los Angeles run resulted in some of the largest number of hours above 50 percent, 55 percent, and 60 percent relative humidity. The mild Los Angeles weather leads to many hours of low space sensible loads thus the terminal unit cannot provide adequate coincidental dehumidification. As expected, Houston has many elevated zone relative humidity hours because the outdoor air has many high dew point temperature hours.

The 54°F dew point temperature DOAS control options (options 2-6) essentially eliminate zone occupied cooling hours above 60 percent relative humidity in all cities. The number of hours above 50 percent and 55 percent remain high in all cities with Seattle once again an exception with a lower number of hours above 55 percent zone relative humidity. Seattle stands out because it has many hours of low outdoor air dew point temperatures (less than 54°F) not requiring mechanical dehumidification thus the outdoor air dehumidifies the zones.

The 50°F and 45°F dew point temperature DOAS control options (option 7 and 8) offer no hours above 55 percent relative humidity and option 8 offers no hours above 50 percent relative humidity. Their ability to use the treated outdoor air to reduce zone latent loads and help manage zone humidity levels reduces the system dependence on high space sensible loads to enable the zone terminal unit to dehumidify. It is important to note the primary source of space latent load in an office is often the people. These results are for an office space which enjoys a relatively high ventilation rate per person from the DOAS. High people density spaces like conference rooms and classrooms tend to have lower ventilation rates per person. It is likely, even with low dew point temperature air, these spaces will require ventilation rates above the code minimum values to enable desired space humidity control. See the Trane Dedicated Outdoor Air Systems Application Guide (SYS-APG001A-EN) for details on how to calculate the required ventilation rate for proper humidity control.

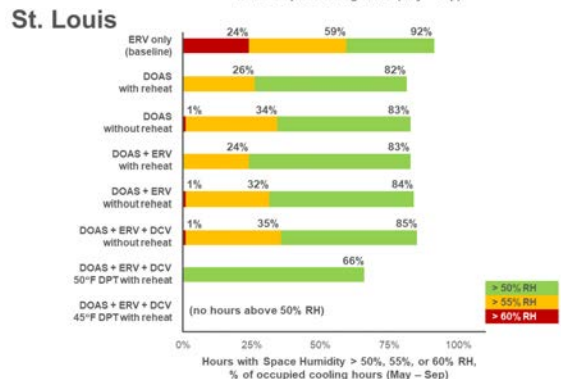
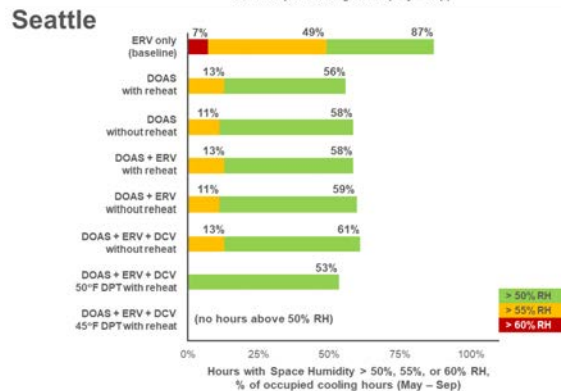
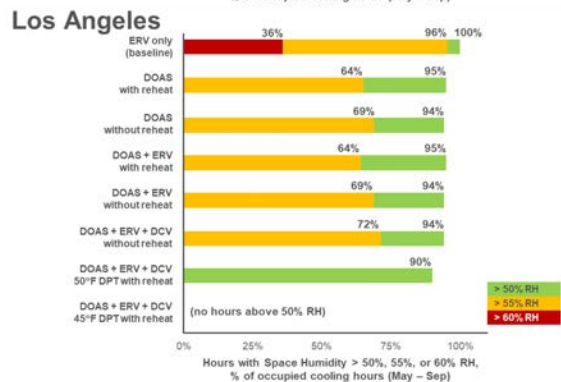
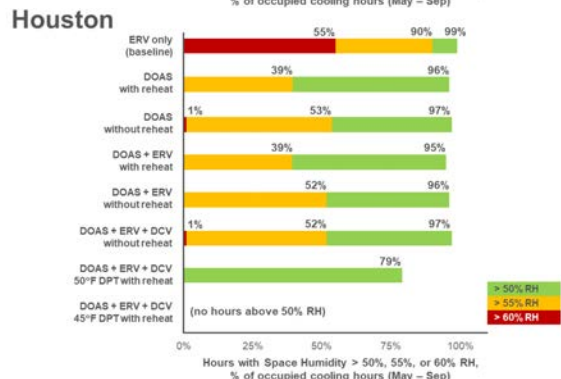
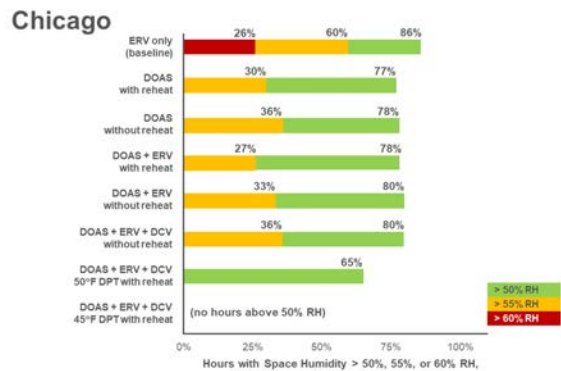

## LEV Kit Control

VRF systems are capable of integrating built up air handlers using LEV kit assemblies. This approach is commonly used in a one-to-one split system configuration for single-zone VAV or DOAS applications.

### Performance Climate Changer® One-to-One DX Split

Factory-installed DDC controls are available on all applied air handlers. The air handlers will use a field-programmed UC600™ controller with an optional color touch screen. The UC600 controls the air handler by modulating or cycling all of the air handler components which includes sending control signals to the linear expansion valve controller (CITY MULTI® LEV Controller PAC-AH001-1). The valve controller is remote mounted in the mechanical room near the refrigerant valves, and requires a separate field supplied power source. The VRF outdoor unit(s) is generally dedicated to the air handler and is remotely located.

Trane Pre-Packaged Solutions (PPS) include logic for field programming of air handling systems. Multiple pre-packaged systems for the UC600 unit controller are available for a VRF heat pump or VRF cooling-only air handler unit. All these systems utilize discharge air control (DAC), where the unit controller maintains a discharge air temperature setpoint. The unit controller will send control signals to each LEV controller, which modulates the electronic valves in response. The LEV sequences are available from one to four stages of DX cooling or heating.

The sequences have an option for an alternative dehumidification mode. During cooling, the air handler will operate with either a call for cooling or dehumidification. This allows the unit to reduce the discharge air temperature to dehumidify the space when needed. This option can be used for dedicated outdoor air systems or VAV mixed air systems.



## Prepackaged Control Options for AHU with LEV Kit and Discharge Air Control

LEV DX Split	Supply fan	Outdoor air control
<ul style="list-style-type: none"> <li>Cooling 1 to 4 stages</li> <li>Heat Pump 1 to 4 stages</li> </ul>	<ul style="list-style-type: none"> <li>Constant Volume</li> <li>Variable Air Volume</li> </ul>	<ul style="list-style-type: none"> <li>Traq™ dampers</li> <li>Economizer control</li> <li>DCV option</li> </ul>
Energy recovery	Auxillary heat	Secondary fan
<ul style="list-style-type: none"> <li>None</li> <li>Total-energy wheel (single exhaust)</li> <li>Total-energy wheel (dual exhaust)</li> <li>Fixed-plate (sensible) heat exchanger</li> </ul>	<ul style="list-style-type: none"> <li>None</li> <li>Hot water</li> <li>Steam</li> <li>Electric</li> <li>Indirect gas-fired burner</li> </ul>	<ul style="list-style-type: none"> <li>None</li> <li>Return with VFD</li> <li>Exhaust with VFD</li> <li>Building pressure control</li> </ul>

## Common Systems for VRF DX split system using LEV kit

**Single Zone VAV:** This system is used for large zones that have variable cooling loads up to 15,000 cfm. The figure below shows fan and discharge temperature control for a single-zone VAV AHU. Fan speed varies to meet the space heating or cooling load while the electronic valve(s) modulate to maintain an adjustable discharge air temperature setpoint. Traq™ dampers are an available option for outdoor airflow measurement to ensure ventilation rates are maintained at various operating conditions.

The Traq™ dampers can also be used to implement demand control ventilation.

Single Zone VAV units are available with airside economizing control. A secondary return or exhaust fan is optional and exhaust air energy recovery is an available option. The PPS sequences include morning warm up and pre-cool modes to precondition the space before occupancy.

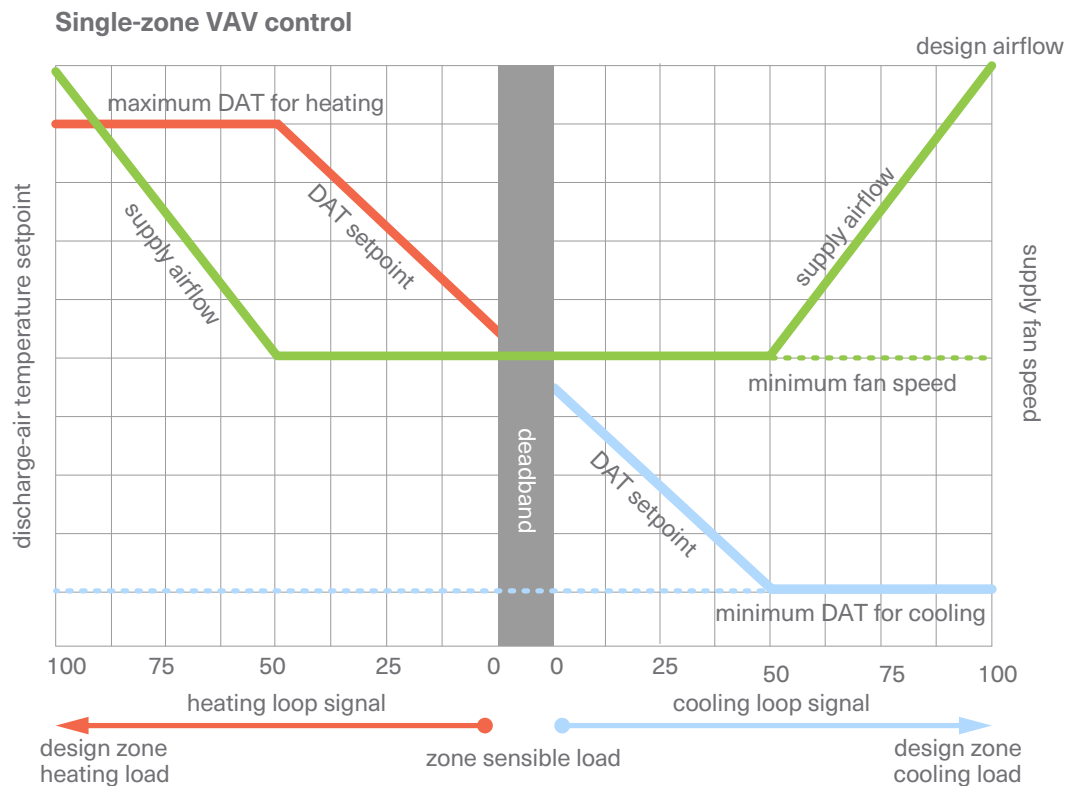

## Dedicated Outdoor Air System (DOAS)

The LEV Kit can also be used to create a DX split DOAS to provide dehumidified ventilation air for multiple zones. This centralizes the outdoor air conditioning for the building. The Performance Climate Changer® air handler may provide air for multiple floors and can overcome high duct static pressure. The DOAS unit heats the air to neutral conditions in the winter and provides cool, dehumidified air to the zones during the cooling season. The space indoor units heat or cool the return air from the zone as needed for comfort. The electronic control valve allows for designing the DX coil as cold as 46°F leaving air temperature.

The design discharge air temperature for a DOAS is typically 46-53°F during cooling and this supply air temperature will be controlled to at part load without without the need for hot gas bypass. During heating, the heat pump will heat the supply air to a discharge air set point. For a DOAS application, normal set points during heating are neutral 68-75°F, but may be reset to high as 95°F for morning warm up. Winter

reheat options include hydronic coils, electric heaters or indirect gas fired heaters, all of which may be desired for back up auxiliary heat or to use during the heat pump defrost cycle. In larger buildings, where the majority of zones need cooling during dehumidification, the usage of hot gas reheat may result in cooling system inefficiency. If warmer air is desired from the unit during peak cooling and dehumidification, prepackaged control solutions exist for dual exhaust air energy recovery units that use sensible heat exchangers or CDQ desiccant wheels to provide dehumidified air using less cooling capacity than cool reheat systems.

Prepackaged control solutions include fan speed control where the supply fan will control to supply duct pressure and exhaust fan to building pressure control. The prepackaged control solutions also include various demand control ventilation strategies and unoccupied control for air handlers configured with a return damper.





# AHU Coil Design and Performance Criteria

## Distributor quantity

Each distributor will include its own LEV controller regardless of tonnage. Only one LEV kit can be connected to a distributor and each distributor requires its own LEV kit. When comparing coil options that have variable distributor quantities, with otherwise identical coil design and capacity, the staging strategy and distributor quantity can provide different levels of coil modulation. For maximum capacity turndown: more coil distributors and LEV-kits can allow greater capacity modulation. If the valves are staged sequentially instead of simultaneously.

Using more distributors and LEV-kits will likely increase installed cost, but may be needed for VAV systems that expect wide operating ranges. Staging multiple distributors simultaneously will provide a smooth transition capacity and often makes sense in constant volume systems as well. VAV systems could benefit from sequential control for additional control flexibility.

## Coil volume

Matching the coil volume to the LEV-kit guidelines is necessary for proper refrigerant charge calculation and to ensure the accumulator is sized properly for the refrigerant charge in the system.

## Coil working pressure requirements

Both heat pump and heat recovery operate the indoor coil as an evaporator and a condenser. The condenser is on the high-pressure side of the refrigerant system, which for R-410A would typically be around 650 psig compared to 480 psig on the low pressure side of the system. The refrigerant coils typically sold in Trane air handling units are typically designed as evaporators to work on the low-pressure side of the refrigerant system. Depending on coil construction and options, most products can be configured to operate as both a condenser and an evaporator by specifying the correct tube diameter and tube wall thickness.

## Tube Diameter and Tube Wall Thickness

All Trane 3/8-inch diameter tube coils are rated for cooling, heat pump, and heat recovery applications. Trane 1/2-inch diameter tube coils require 0.025 inch wall thickness to be used in heat pump or heat recovery applications due to the higher working pressures. CSAA air handlers feature 1/2-inch diameter tube coils with 0.025-inch wall thickness as a standard option. 5/8-inch diameter tube coils are not pressure rated for R410A refrigerant in either evaporator or condenser applications.

Tube Thickness					
Tube diameter (inches)	Unit ventilator	BCXD	UCCA	CSAA	AHU replacement & shipping coils
3/8	standard	standard	standard	standard	standard
1/2	n/a	n/a	0.025-inch (special)	0.025-inch	0.025-inch
5/8	n/a	n/a	n/a	n/a	n/a

## Air Handler Design Criteria

### Fan motor and controls implications

Air handlers have maximum leaving air temperature restrictions based on product type, materials of construction, unit configuration, unit controls, and fan motor classifications. VRF systems are often controlled with discharge air temperature control or zone temperature control.

In discharge air temperature control, the maximum leaving air temperature in heating mode is limited to 83°F in the LEV kit controls with options up to 95°F using dipswitch settings. This leaving air temperature poses no issues for any air-handling unit configuration.

In zone temperature control, the leaving air temperature will climb as high as possible to satisfy the space load. This can often climb as high as 120°F depending on system configuration, airflow, entering air temperature, as well as the outdoor ambient temperature. Although most air-handling unit designs have options, some fan motor configurations cannot be located in airstreams above 104°F due to an appropriate motor temperature rise safety factor for the various motor insulation classes available.

Depending on the air handler type, various unit configurations and motor selections can alleviate any concern with high leaving air temperatures when using zone temperature control.

VFD, starter, or controls boxes are limited to airstreams of 104°F and lower. Due to this consideration, these devices should be located upstream of the VRF refrigerant coil when using zone temperature control.

The chart below depicts permitted configurations with the two control methodologies.

### Outdoor AHU

Air handling units located outdoors will need to take into account that the LEV control box is NEMA 1 rated. Locating the LEV control box in a pipe cabinet or other code approved location should be considered.

		Zone temperature control	Discharge air control
Unit ventilator	vertical unit ventilator	x	x
Blower coil	1-phase motors	n/a	x
	3-phase motors	x	x
UCCA, CSAA	draw-thru	varies*	x
CSAA	blow-thru	x	x

\*not permitted with certain motor manufactureres and sizes

# Design Resources

There are a number of resources available to design, select, and configure a VRF system. These include selection tools for the equipment, configuration, and programming tools for the controls.

## TRACE® 3D Plus design and analysis software

The latest version of TRACE 3D Plus features:

- **Expanded VRF equipment libraries**– including Trane-Mitsubishi validated equipment performance data
- **Adaptive modeling** accounts for four operating modes specific to system performance including increased energy use during heat-recovery
- **Packaged dedicated outdoor air configurations** and control mode capability
- **Detailed modeling** accounts for impact of compressor staging and low load cycling, pipe length, heat recovery operation and climate-affected defrost operation

## Selection

Selection of Trane VRF Systems is divided into three selection programs: Trane Select Assist™, Diamond System Builder, and the Dedicated Outdoor Air Solutions selection tool.

- **Trane Select Assist** – [www.traneselectassist.com](http://www.traneselectassist.com) – Used to select Unit Ventilators, Blower Coil air handlers, Performance Climate Changers, standalone cooling coils (for retrofit or custom AHU installations) and LEV kits
- **Diamond System Builder** – used to select VRF equipment including: air- and water-cooled condensing units, indoor terminal units, branch controllers, unit controls, Outdoor Air Processing (OAP) units, and Lossnay ERVs. See page 68 for more information.

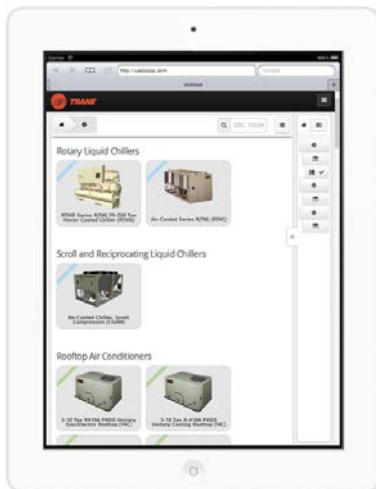

### Trane Select Assist® Inputs:

Choose “Yes” in the VRF Application input to enable a VRF application:

<b>VRF Application</b>	Yes ✓
	No

For some products, an additional input for zone or discharge temperature control is required. This input is used to identify potential problems with a high discharge air temperature when the unit operating in heat pump heating mode.

<b>VRF Temperature control</b>	Zone temperature control
	<b>Discharge temperature control</b> ✓

Once a selection is made, an LEV kit recommendation will be output if all rules governing LEV kit selection are satisfied. Note that the LEV kit is field-provided and is not ordered through Trane Select Assist.

### Trane Select Assist Outputs:

<b>VRF Application</b>	Yes
<b>VRF Temperature control</b>	Discharge temperature control
<b>Number of LEV</b>	1
<b>LEV Controller Quantity</b>	PAC-AH001-1 quantity 1 suggested
<b>LEV Model Suggested</b>	PAC-LV60AC-1 suggested
<b>LEV Tonnage</b>	5 Ton
<b>Refrigerant pressure drop check for LEV</b>	Pass
<b>Refrigerant pressure drop for LEV kit</b>	4.65 psig
<b>Refrigerant volume for LEV kit</b>	103.28 cu in

In this example, an LEV kit selection is available meaning all LEV kit selection rules were satisfied. A single 5-ton valve and a single PAC-AH001-1 controller are recommended.

Note that the number of LEV kits required will be based on the number of distributors provided on the coil (each distributor requires its own LEV kit).

# Diamond System Builder

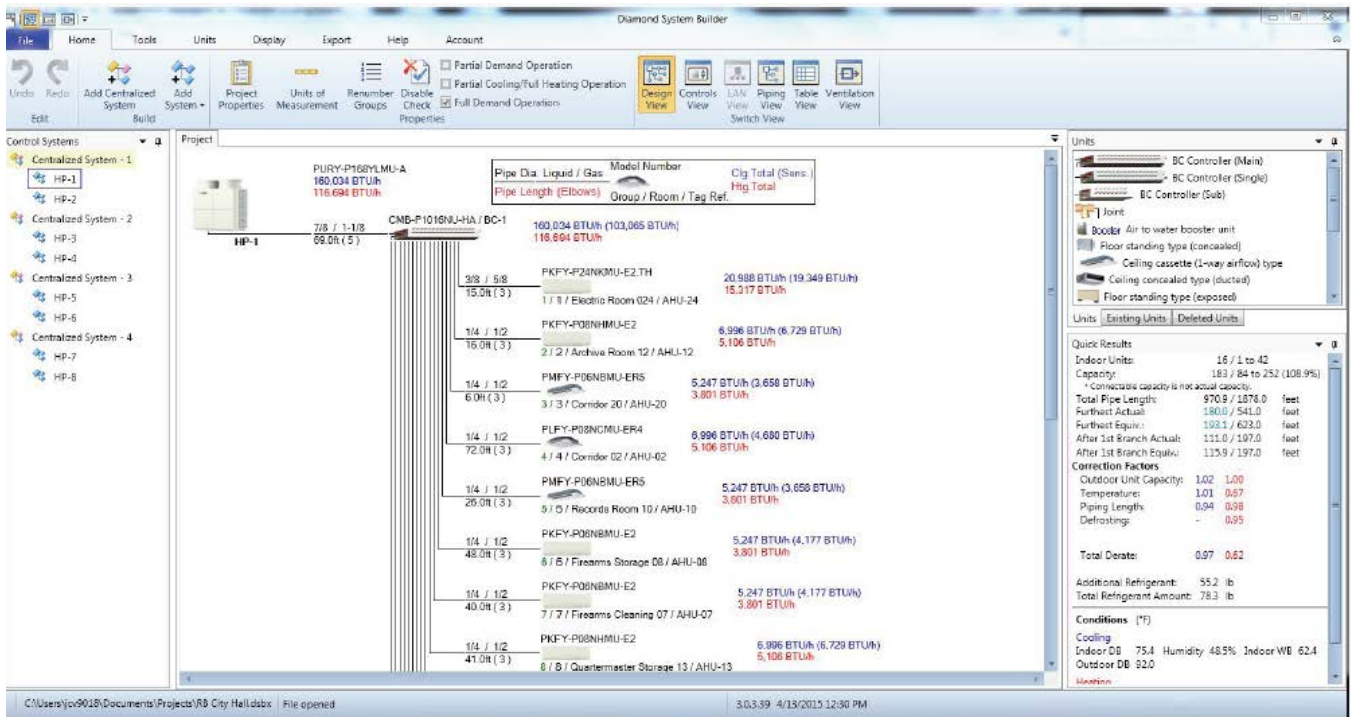

Diamond System Builder® (DSB) is the primary system design and layout tool for a VRF terminal system. The software is also used to select many of the components that make up a terminal system, or are used in conjunction with a ventilation system.

In particular, the following products are selectable in Diamond System Builder:

- Indoor units:
  - Wall-mounted
  - Ceiling recessed (4-way and 1-way)
  - Ceiling-suspended
  - Ceiling-concealed
  - Floor-mounted
  - Multi-position Air Handlers
  - Hydronic heat exchangers
- Branch controllers
- Condensing units
- Lossnay ERVs
- Outdoor Air Processing (OAP) units

Diamond System Builder can provide the cooling and heating performance for these products based on project-specific conditions. It is a robust system and component selection tool with built-in safeguards against exceeding limitations, assuring line lengths, maximum connected capacities, component selections, control schemes, etc. are all within the system requirements.

Diamond System Builder provides functions to customize the system layout for each project. The software can also provide system schedules, submittal packages, and Revit® or AutoCAD® drawings.

# Pre-packaged Solutions

Trane BAS technicians have access to the PPS Configurator tool and Trane Select Assist that are used to develop control packages for a variety of applied solutions including air handlers that use the LEV kit. These packages include sequence of operations, points list, programs and flow sketches.

These can be combined with the VRF indoor unit information including the riser diagrams to make a single control package.

## Control Flow Diagram

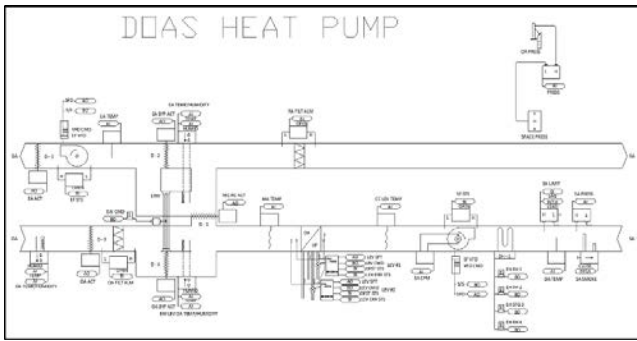

## Sequences

### SINGLE ZONE VAV

#### Pre-Cool Mode:

During optimal start, if the space temperature is above the occupied cooling setpoint, pre-cool mode shall be activated. When pre-cool is initiated the unit shall enable the fan and cooling or economizer. The outside air damper shall remain closed, unless economizing. When the space temperature reaches occupied cooling setpoint (adj.), the unit shall transition to the occupied mode.

#### Optimal Stop:

The BAS shall monitor the scheduled unoccupied time, occupied setpoints and space temperature to calculate when the optimal stop occurs. When the optimal stop mode is active the unit controller shall maintain the space temperature to the space temperature offset setpoint. Outside air damper shall remain enabled to provide minimum ventilation.

#### Occupied Bypass:

The BAS shall monitor the status of the "on" and "cancel" buttons of the space temperature sensor. When an occupied bypass request is received from a space sensor, the unit shall transition from its current occupancy mode to occupied bypass mode and the unit shall maintain the space temperature to the occupied setpoints (adj.).

#### Heat/Cool Mode:

When the space temperature rises above the occupied cooling setpoint the mode shall transition to cooling. When the space temperature falls below the occupied heating setpoint the mode shall transition to heating. When the space temperature is above the occupied cooling setpoint or below the occupied heating setpoint the mode shall remain in its last state. If the space temperature sensor fails the mode shall remain in its last state and an alarm shall be annunciated at the BAS. If the local and communicated setpoints fail the controller shall disable the supply fan and an alarm shall be annunciated at the BAS.

#### Supply Air Temperature Reset Control:

On a rise in space temperature (+2.0 deg. F adj. or greater) above the space cooling setpoint (74.0 deg. F adj.); the supply fan speed shall modulate from minimum (50% adj.) to maximum (or design) air flow to maintain space cooling temperature setpoint while keeping the discharge air temperature setpoint at minimum (55.0 deg. F adj.).

As space temperature decreases below 76.0 deg. F (space cooling setpoint 74.0 deg. F + 2.0 deg. F); the fan speed shall be locked at minimum air flow and the discharge air temperature setpoint remains at minimum.

When space temperature decreases to 75.0 deg. F (cooling setpoint of 74.0 deg. F adj. + 1.0 deg. F) or below for a period of time (default 1 min. adj.); the fan speed shall remain at minimum, the discharge air temperature setpoint remains at minimum, and control enters into discharge air temperature setpoint reset mode.

As space temperature continues to drop below 75.0 deg. F (space temperature cooling setpoint + 1.0 deg. F); the fan speed shall remain at minimum and the discharge air temperature setpoint shall be reset

## Graphics

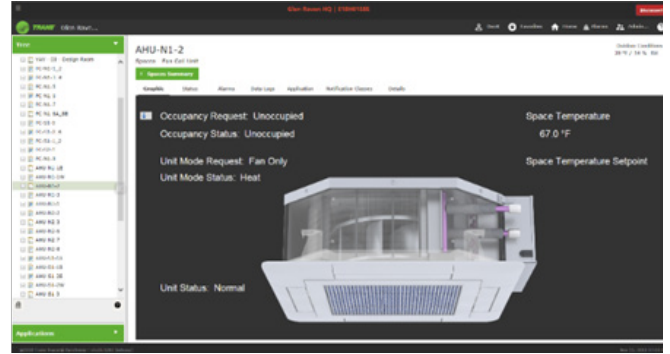

## Riser Diagram

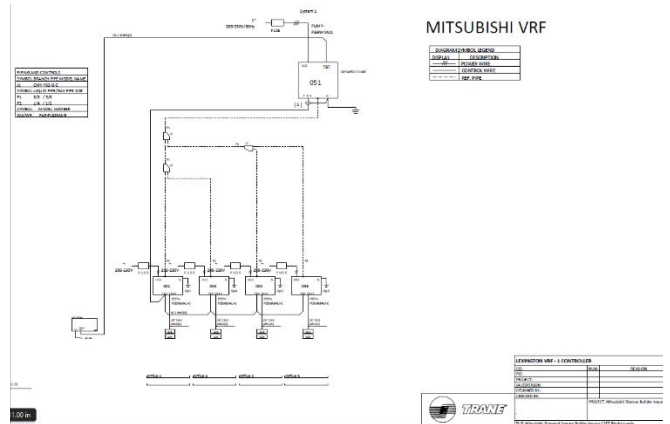

## Points List

PointName	Type	Instance	Termination
Economizer Pgain	AV	38	UC600:software
Cooling Capacity Status	AV	52	UC600:software
Mixed Air Low Limit Setpoint BAS	AV	39	UC600:software
Outdoor Air Damper Safety Pgain	AV	41	UC600:software
Outdoor Air Minimum Position Setpoint BAS	AV	33	UC600:software
Economizer Minimum Position Setpoint Active	AV	154	UC600:software
LEV Outlet Air Temperature	AV	286	UC600:software
LEV Inlet Air Temperature	AV	285	UC600:software
LEV Comanded Set Point	AV	282	UC600:software
LEV Set Point Offset	AV	287	UC600:software
Cooling Capacity Request	AV	124	UC600:software
DX Heat Command Request	AV	182	UC600:software
Optional CoolCoil Control Command	AV	137	UC600:software
LEV Heating Thermo ON Setpoint	AV	284	UC600:software
LEV Cooling Thermo ON Setpoint	AV	283	UC600:software
LEV Stage 1 Setpoint Command	AO	1	UC600:software
LEV Stage 2 Setpoint Command	AO	2	UC600:software
LEV Sample Time Minutes Elapsed	AV	289	UC600:software
LEV Capacity Deadband	AV	290	UC600:software
LEV Sampling Period Minutes	AV	288	UC600:software
Cooling PID Output	AV	139	UC600:software
Heating Capacity Secondary Status	AV	64	UC600:software
Supply Fan Speed Command	AO	3	UC600:ao3/ui11
Mixed Air Damper Command	AO	21	UC600:ao6/ui14
Mixed Air Temperature Local	AI	15	UC600:ui3
Discharge Air Temperature	AI	11	UC600:ui4
Supply Fan Air Flow Pressure	AI	13	UC600:ui7
Outdoor Air Temperature Local	AI	21	XM30-1:ui02
Outdoor Air Relative Humidity Local	AI	49	XM30-1:ui03
Cooling Coil Leaving Temperature	AI	16	XM30-4:ui02

## LEV Kit Selection Information

When selecting an LEV kit, or when estimating coil performance, certain performance parameters will be needed. These parameters will change depending on which mode is being analyzed: cooling or heating.

### Cooling performance

For cooling performance, the saturated suction temperature (SST) and liquid temperature are needed. The saturated suction temperature is based on outdoor ambient temperature and line length. The liquid temperature is based on ambient temperature only. These temperatures are detailed in table on the right.

Saturated suction temperature (°F)

Outdoor ambient (°F)	Line length (feet)				
	<100	165	230	295	361
≤95	40	41.25	42.5	43.75	45
105	41	42.25	43.5	44.75	46
115	42	43.25	44.5	45.75	47
>115	contact factory				

Liquid temperature (°F)

Outdoor ambient (°F)	Liquid temperature (°F)
≤95	80
105	85
115	90
>115	contact factory

### Heating performance

Heating performance will require two temperatures as input.

The two temperatures—the hot gas/superheated refrigerant temperature entering the coil and the saturated discharge/condensing temperature—are based on the outdoor ambient temperature only. These temperatures are tabled below.

The resulting capacity should be compared to the heat available from the condensing unit. This value is based not only on the outdoor ambient temperature, but also on the choice of condensing unit. This information is available from your Trane® account manager.

Coil design temperatures		Outdoor ambient (°F)						
		-13	-3	7	17	27	37	47
Standard and high efficiency condensing units	superheated refrigerant entering coil temp °F	182	182	178	176	176	176	170
	Coil condensing temperature °F	94	100	103	107	114	120	120

Coil design temperatures		Outdoor ambient (°F)						
		-13	-3	7	17	27	37	47
Hyper heat condensing units	superheated refrigerant entering HEX temp °F	150	160	170	170	170	170	170
	Coil condensing temperature °F	107	114	120	120	120	120	120

## *Additional VRF Resources*

### **Industry Resources**

ASHRAE. 2016 HVAC Handbook – Systems and Equipment, Chapter 18. Available from [www.ashrae.org/bookstore](http://www.ashrae.org/bookstore)

### **Trane and Mitsubishi Electric Trane US, LLC Resources**

City Multi® VRF, Catalog, October 2019

[Trane.MyLinkDrive.com](http://Trane.MyLinkDrive.com)

Diamond System Builder from Mitsubishi Electric Trane US, LLC

### **Trane Resources**

“Applying Variable Refrigerant Flow”, Trane Engineers Newsletter Live, May 2014

“Dedicated Outdoor Air Equipment”, Engineers Newsletter Live, October 2011

“Dedicated Outdoor-Air Systems”, Engineers Newsletter Live, September 2001

“Impact of DOAS Dew Point on Space Humidity”, Trane Engineers Newsletter Live, March 2020

Guckelberger, D. “ASHRAE Standard 15 Applied to Packaged, Split and VRF Systems”, Engineers Newsletter 37-1 (2008)

Murphy, J. “Impact of DOAS Supply-Air Dew Point Temperature on Space Humidity”, Engineers Newsletter 49-1 (2020)

Murphy, J. “AHRI 920-Rating Standard for DX Dedicated Outdoor-Air Units”, Engineers Newsletter 45-4 (2016)

Murphy, J. “CO<sub>2</sub>-Based Demand-Controlled Ventilation with ASHRAE Standard 62.1-2004”, Engineers Newsletter 34-5 (2005)

Murphy, J. “Advances in Dessicant-Based Dehumidification”, Engineers Newsletter 34-4 (2005)

Stanke, D. “Design Tips for Effective, Efficient Dedicated Outdoor-Air Systems”, Engineers Newsletter 30-3 (2001)

“Dedicated Outdoor Air Systems”, Application Guide, SYS-APG001A-EN (2019)

“Dehumidification in HVAC Systems”, Applications Engineering Manual, SYS-APM004-EN (2002)

“Refrigerating System and Machinery Rooms”, Applications Engineering Manual, APP-APM001-EN (2012)

TRACE™ 3D Plus HVAC system design and analysis software. Visit [www.trane.com/TRACE3DPlus](http://www.trane.com/TRACE3DPlus)



Trane - by Trane Technologies (NYSE: TT), a global climate innovator - creates comfortable, energy efficient indoor environments for commercial and residential applications. For more information, please visit [trane.com](https://trane.com) or [tranetechnologies.com](https://tranetechnologies.com).

Trane has a policy of continuous product and product data improvement and reserves the right to change design and specifications without notice. We are committed to using environmentally conscious print practices.

All trademarks referenced are the trademarks of their respective owners.

© 2022 Trane All Rights Reserved  
APP-PRC007C-EN April 2022  
Supersedes APP-PRC007B-EN November 2020

[trane.com](https://trane.com)