



TRANE®

OPERATION AND INSTALLATION MANUAL

TCONTWEBBAC02 Manual

Thank you for purchasing our product.
Read this manual carefully before using this product and keep it for future reference.

Table of Contents

PART 1. FUNCTION OVERVIEW	1
1 Installation Diagram	1
1.1 Product Dimensions	1
1.2 Installation Diagram	1
2 Connection Indication	2
2.1 Interface Definition	2
2.2 System Connection Diagram	2
3 Product Description	3
3.1 Device Monitor	3
3.2 Supported Models	3
3.3 Based on Web Technologies	3
PART 2 . BACNET FUNCTION OVERVIEW	4
1 Applications	4
2 Features	4
3 Specifications	4
4 Statement on Conformity of BACnet Protocol Implementation	4
4.1 Product Description	4
4.2 Supported BACnet Consistency Categories	4
4.3 Supported BACnet Function Groups	5
4.4 Supported BACnet Protocol Application Services	5
4.5 Supported Protocol Object Categories	6
4.6 Data Link Layer Options	6
4.7 Supported Character Sets	7
4.8 Special Functions	7
5 Configuration Instructions	7
5.1 Time and Date Settings	7
5.2 Safety Settings	7
5.3 Network Settings	7
5.4 BACnet Settings	8
6 Object List	8
6.1 BACnet Objects for Indoor Units	8
6.2 Object List for Outdoor Units	12
6.3 Object List for HTHM Units	14
6.4 Error Code	16
PART 3 . M-Interdace FUNCTION OVERVIEW	17
1 Select Language	17
2 Login	17
3 Home Page	19
3.1 Overview of Indoor Unit Running Status	19
3.2 Device Status List	20
3.3 Function Menu	22
3.4 Special Menu	22
4 Control	23

4.1 Indoor Unit View - Group	26
4.2 Indoor Unit View - System	29
5 Schedule	29
5.1 View Schedule	30
5.2 Add Schedule	34
6 Report	41
6.1 Operating Duration	42
6.2 Running Record	44
6.3 Energy Statistics	45
6.4 Log	47
6.5 Export Function	47
7 Eco	48
8 Install	52
8.1 Edit	52
8.2 Group	52
8.3 Add indoor unit to group	54
9 Setting	59
9.1 Account	56
9.2 Date	58
9.3 Holiday Settings	60
9.4 General Settings	61
9.5 Advanced Settings	62
9.6 Public Device	64
9.7 ECS	65
10 APPENDIX	65
10.1 Table of Error Codes	65
10.2 Software Use Precautions	70
10.3 Wired Controller Group	70

PART 1. FUNCTION OVERVIEW

1 Installation Diagram

1.1 Product Dimensions

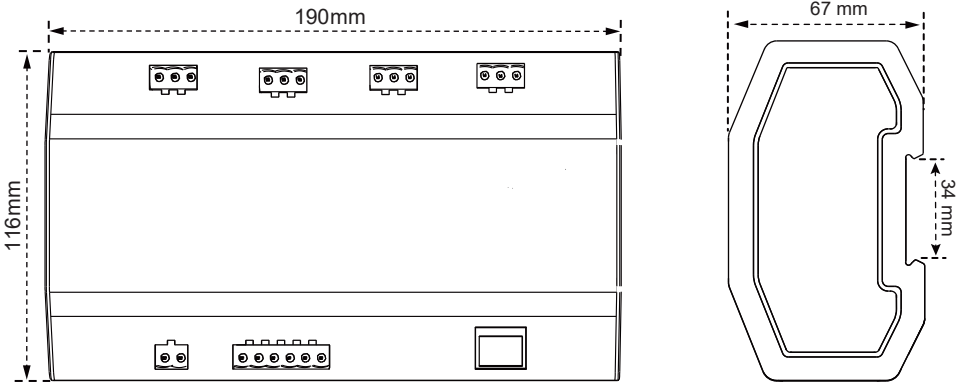

1.2 Installation Diagram

The product uses the rail-type installation method: first secure the rail in the packing carton to the position where the product will be installed, and then fasten the spring of the gateway on the rail.

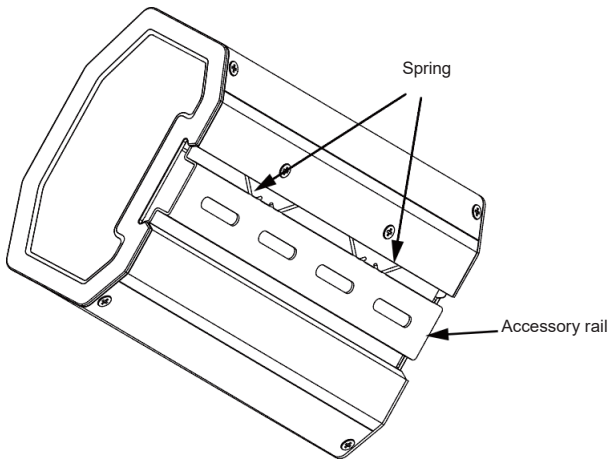

2 Connection Indication

2.1 Interface Definition

Ethernet interface connection to BACnet/IP network.

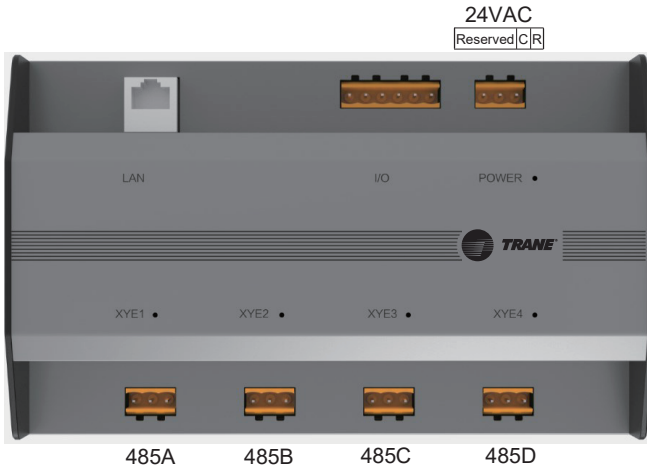

Port connection from air conditioner to X/Y/E bus of outdoor unit.

2.2 System Connection Diagram

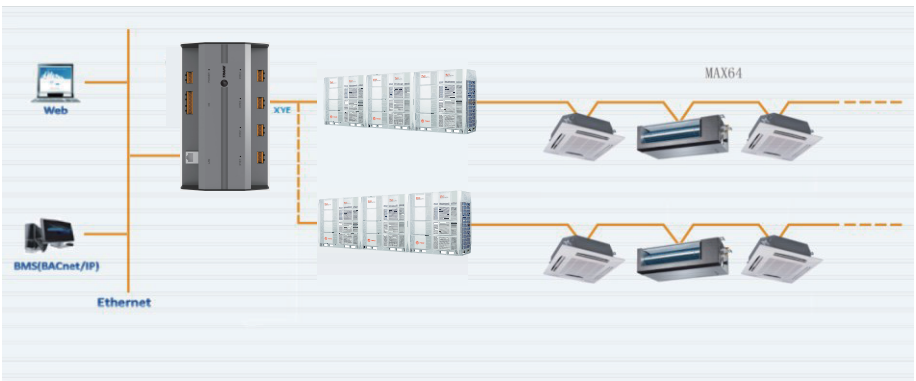

Note

The gateway must be on the same network segment as the upper computer of the building's control system, or it will not be able to communicate with the upper computer.

3 Product Description

Every main wire in this device can connect with a maximum of 64 indoor and 32 outdoor units. The device features 4 main wires and can connect with a total of 384 indoor and outdoor units. It features a built-in TCONTWEBBAC02 function module and TCONTCNTSUT gateway function module. The gateway can be used with TCONTCNTSUT to enable the power billing function. The TVR system and building management system are also integrated.

3.1 Device Monitor

- 1) Integrate with the building's system: the building management system obtains information about the indoor and outdoor units by accessing a specific BACnet object. For details, refer to the corresponding "object list". You can use the building management system to set the operating status of the indoor unit by changing the corresponding BACnet object. Refer to the corresponding "Object List" for details.
- 2) Integrate with the TCONTCNTSUT for TVR central air conditioner: this enables the power billing function for the TVR unit. Or log into the web interface of TCONTCNTSUT gateway section under the monitoring gateway to monitor multiple connections. For more details, see the TCONTCNTSUT gateway operation section of this manual.

3.2 Supported Models

* Please confirm with factory engineers regarding the models and functions of indoor and outdoor units.

3.3 Based on Web Technologies

Using the WEB debugging function (it is recommended that you use the Google Chrome browser), the gateway can connect to the local area network via the switch. The computer or device must share the same network segment as the IP address of the central monitoring gateway.

- 1) This gateway's default IP address is 192.168.1.8, which can be used to log in to the debugging page of the TCONTWEBBAC02 function.
- 2) Integrate with the TCONTCNTSUT for TVR central air conditioner: this enables the power billing function for the TVR unit. Or log into the web interface of TCONTCNTSUT gateway section under the monitoring gateway to monitor multiple connections. For more details, see the TCONTCNTSUT gateway operation section of this manual.

The web login address for the TCONTCNTSUT gateway function is: gateway IP: 8000. If the gateway is 192.168.1.8, the web server address is: <http://192.168.1.8:8000/ui/login/login.html>. The webpage function section consults the pure gateway function section.

PART 2. BACNET FUNCTION OVERVIEW

1 Applications

It is used for communications between the TVR system and the building management system that has the BACnet interface, to integrate the TVR system with the building management system.

2 Features

Connect the TVR system to the BACnet network.

Support TCONTWEBBAC02 protocols, and comply with BACnet standards.

Each port can be connected to a maximum of 64 indoor units, and the total number of indoor and outdoor units on all 4 ports is 384 at most.

Plug-in terminal interface is used to facilitate the wiring.

3 Specifications

No.	Function	Description
1	Input power	24VAC 50/60Hz
2	Communication interface	4X RS485 interface 1X RJ45 Ethernet port Ethernet port
3	Operating environment	Temperature: 0-40°C
4	Weight	800g

4 Statement on Conformity of BACnet Protocol Implementation

4.1 Product Description

The BACnet gateway monitors the outdoor and indoor TVR units via the RS485 interface, and communicates with the building management system using the TCONTWEBBAC02 interface.

4.2 Supported BACnet Consistency Categories

Category3	
-----------	---

4.3 Supported BACnet Function Groups

COV event initialization	<input checked="" type="checkbox"/>	Device communications	<input type="checkbox"/>
COV event response	<input type="checkbox"/>		

4.4 Supported BACnet Protocol Application Services

Applicable Service	Initiate a request	Execute the request
Verified COV notifications	<input checked="" type="checkbox"/>	<input type="checkbox"/>
Reserved for COV	<input type="checkbox"/>	<input checked="" type="checkbox"/>
Non-verified COV notifications	<input checked="" type="checkbox"/>	<input type="checkbox"/>
Read attributes	<input type="checkbox"/>	<input checked="" type="checkbox"/>
Read multiple attributes	<input type="checkbox"/>	<input checked="" type="checkbox"/>
Write attribute	<input type="checkbox"/>	<input checked="" type="checkbox"/>
Write multiple attributes	<input type="checkbox"/>	<input checked="" type="checkbox"/>
Device communications and control	<input type="checkbox"/>	<input checked="" type="checkbox"/>
Who-Has	<input type="checkbox"/>	<input checked="" type="checkbox"/>
I-Have	<input checked="" type="checkbox"/>	<input type="checkbox"/>
Who-Is	<input type="checkbox"/>	<input checked="" type="checkbox"/>
I-Am	<input checked="" type="checkbox"/>	<input type="checkbox"/>

4.5 Supported Protocol Object Categories

Object Type	Support?	Can this be dynamically created?	Can this be dynamically deleted?	Optional attribute	Writeable attribute
Analogue input	<input checked="" type="checkbox"/>	<input type="checkbox"/>	<input type="checkbox"/>	_____	_____
Analogue output	<input checked="" type="checkbox"/>	<input type="checkbox"/>	<input type="checkbox"/>	_____	_____
Analogue	<input checked="" type="checkbox"/>	<input type="checkbox"/>	<input type="checkbox"/>	_____	_____
Binary input	<input checked="" type="checkbox"/>	<input type="checkbox"/>	<input type="checkbox"/>	_____	_____
Binary output	<input checked="" type="checkbox"/>	<input type="checkbox"/>	<input type="checkbox"/>	_____	_____
Binary	<input checked="" type="checkbox"/>	<input type="checkbox"/>	<input type="checkbox"/>	_____	_____
Device	<input checked="" type="checkbox"/>	<input type="checkbox"/>	<input type="checkbox"/>	_____	_____
Multiple input status	<input checked="" type="checkbox"/>	<input type="checkbox"/>	<input type="checkbox"/>	_____	_____
Multiple output status	<input checked="" type="checkbox"/>	<input type="checkbox"/>	<input type="checkbox"/>	_____	_____
Multiple status values	<input checked="" type="checkbox"/>	<input type="checkbox"/>	<input type="checkbox"/>	_____	_____

4.6 Data Link Layer Options

<input checked="" type="checkbox"/>	ISO 8802-3, 10BASET
-------------------------------------	---------------------

4.7 Supported Character Sets

Support for multiple character sets does not imply that all these character sets are supported at the same time.



ANSI X3.4

4.8 Special Functions

Segment request support



yes



no

Window size: **1476**

Segment response support



yes



no

Window size: **1476**

5 Configuration Instructions

Before use, you need to configure the device. To access the configuration page, start a browser and enter the device IP address.

5.1 Time and Date Settings

You can set the date and time. The settings take effect immediately.

5.2 Safety Settings

You can set the admin password. The settings take effect immediately. The admin account is "admin", and the default password is "123456".

5.3 Network Settings

The default IP address of the Ethernet port is "192.168.1.8". You may ask the network administrator to assign an IP address according to actual circumstances. Then, you can access the configuration page to change the IP address of the gateway. A pure gateway.

5.4 BACnet Settings

The BACnet network number is in the range of 2~254. You need to restart the device for the new settings to take effect. Different gateways must have different BACnet network numbers, and the same network number cannot be used for other devices. The rules to generate the BACnet device instance number are as follows:

BACnet device instance number for indoor unit = (BACnet network number * 10000) + (Port number * 1000) + (Indoor unit address);

BACnet device instance number for outdoor unit = (BACnet network number * 10000) + (Port number * 1000) + 100 + (Outdoor unit address).

485 port number: 0~3. For the 485 port near the network port, the number is 0. Indoor unit address: 0~63; outdoor unit address: 0~31.

Note: The control operation of the air conditioner should not be too frequent, so that the command cannot be executed in time and the command is lost. It is recommended that commands be spaced at least 200 milliseconds apart.

6、 Object List

The following describes the abbreviations used for different object types:

Object Type	Abbreviation
Analog Input	AI
Analog Output	AO
Analog Value	AV
Binary Input	BI
Binary Output	BO
Binary Value	BV
Multi-state Input	MI
Multi-state Output	MO
Multi-state Value	MV

6.1 BACnet Objects for Indoor Units

The BACnet device for each indoor unit provides the following objects.

Object ID	Object Name	Current Value Description	R/W
AI 1	Room Temperature	Room temperature in °C	R
AI 7	Malfunction Code	Error Code (see 6.4)	R
AI 8	Outlet Air Temperature	Outlet Air Temperature in °C	R
AI 9	EXV Opening	EXV Opening	R
AI 10	Software Version	Software version	R
AI 11	Indoor type	Indoor type 0、 4-Way Cassette (4-WAY) 1、 4-Way Cassette (4-WAY) 2、 Wall-mounted 3、 Medium Static Pressure Duct (M-Duct) 4、 Low Static Pressure Duct (L-Duct) 5、 Air Handling Unit (AHU) 6、 High Static Pressure Duct (H-Duct) 7、 Compact 4-Way Cassette (COMPACT) 8、 Ceiling & Floor 9、 Floor Standing 10、 Floor Standing 11、 Fresh Air Processing Unit 12、 Inverter Split AC 13、 Heat Recovery Ventilator (HRV) 14、 1-Way Cassette 15、 2-Way Cassette 16、 Console 17、 High temperature hydro module (HTHM) 18、 Fresh Air Processing Unit 20、 Fresh Air Processing Unit 21、 AHUKIT (return air control) 22、 Floor standing 24、 AHUKIT (discharge air control)	R
AI 12	Indoor Horses	Indoor Horses	R
AI 13	T2A	T2A temperature in °C	R
AI 14	T2B	T2B temperature in °C	R

Object ID	Object Name	Current Value Description	R/W
BI 2	Alarm Indication	Indicates the error status of the indoor unit: 0 - No error; 1 - Error	R
BV 1	On/Off Setting	ON/OFF Settings for Indoor Units 0 - OFF 1 - ON. When ON is selected, the operating mode, fan speed, and temperature settings are sent based on records from the most recent time the indoor unit was used. If the indoor unit is turned off when the gateway first comes online, the default settings will be cooling at 24 degrees Celsius, with low fan speed (1).	RW
BV 4	Remote Control Lock Setting	0 - Unlock remote control; 1 - Lock remote control	RW
BV 5	Controller Lock Setting	0 - unlock wired controller, 1 - lock wired controller	RW
MV 1	Mode Setting	TVR IDU: 1-OFF; 2-FAN; 3-COOL; 4-HEAT; 5-AUTO; 6-DRY HRV unit: 1-OFF; 2-FREE COOL; 3-HEAT EXCHANGE; 4-BYPASS; 5-AUTO;	RW
MV 2	Fan Speed Setting	Fan speed setting: Fan speed setting: 1~7: 1~7 fan speed; 8 - AUTO; 9 indicates that the fan is off (only used to show the status of the fan, cannot set the fan speed to off). For models with 3 fan speeds: 1, 2 - low fan speed; 3, 4 - mid fan speed; 5, 6, 7- high fan speed.	RW
MV 3	Mode Limit Setting	The current value, "1", indicates the mode limit is unlocked, "2" indicates the cooling mode is locked, and "3" indicates the heating mode is locked. For indoor units that do not support mode lock, the setting for this variable is not valid.	RW
MV 5	Fan Lock/Unlock Setting	1~7: 1~7 - Lock fan speed; 8 - Unlock. For models with 3 fan speeds: 1, 2 - Lock on low fan speed; 3, 4 - Lock on mid fan speed; 5, 6, 7 - Lock on high fan speed.	RW
AV 1	Temperature Setting	Temperature setting, unit is °C, range is 10-30.	RW

Object ID	Object Name	Current Value Description	R/W
AV 2	Dual Point (Cooling) Setting	The set cooling temperature for AUTO mode must be greater than or equal to the set heating temperature for AUTO mode. Otherwise, the gateway may automatically change the set cooling temperature to make its value the same as the set heating temperature. If non-automatic mode is used, this is equivalent to AV 1. range is 10-30. (unit: °C)	RW
AV 3	Dual Point (Heating) Setting	The set heating temperature for AUTO mode must be less than or equal to the set cooling temperature for AUTO mode. Otherwise, the gateway may automatically change the set heating temperature to make its value the same as the set cooling temperature. This variable is valid only when the indoor unit runs in AUTO mode. When not in AUTO mode, this variable is invalid. range is 10-30. (unit: °C)	RW
AV 4	Cooling Temperature Limit Setting	The current value, "0", indicates that the lower limit of the cooling temperature is unlocked, while "17~30°C" indicates the lower limit of the cooling temperature. For indoor units that do not support the feature to lock the lower limit in cooling mode, the setting for this variable is not valid.	RW
AV 5	Heating Temperature Limit Setting	The current value, "0", indicates that the upper limit of the heating temperature is unlocked, while "17~30°C" indicates the upper limit of the heating temperature. For indoor units that do not support the feature to lock the upper limit in heating mode, the setting for this variable is not valid.	RW
AV 6	Swing Setting	0 - Maintain the current swing angel, 0 - Maintain the current swing angel, 1~5 - Swing angle 1-5, 6- Auto swing off, 7- Auto swing on.	RW

R indicates that the object's current value is read-only. W indicates that the object's value can be written. "RW" indicates that the current value of the variable corresponds to the current status of the indoor unit, and this value can be written to change the related status of the indoor unit.

Notes:Some models do not support all of the above parameters, please contact technical support engineer for details.For example: Indoor units in cooling only system do not support auto or heating modes,if auto or heating modes are required , the actual operating mode of the indoor units may not be the same as expected.

6.2 Object List for Outdoor Units

The BACnet device for each outdoor unit provides the following objects:

Object ID	Object Name	Current Value Description/Notes	R/W
MI 1	Mode Status	Operating Mode for Outdoor Unit 1 - Off; 2 – Reserved; 3 - Cooling; 4 – Heating; 5 - Forced Cooling; 6 - Master Cooling; 7- Master Heat; 8 - Forced Heat	R
BI 1	On/Off Status	0 - OFF; 1 - ON	R
BI 2	Alarm Indication	0 indicates that there is no error;1 indicates an error	R
BI 3	SV1	SV1	R
BI 4	SV2	SV2	R
BI 5	SV3	SV3	R
BI 6	SV4	SV4	R
BI 7	SV5	SV5	R
BI 8	SV6	SV6	R
BI 9	SV7	SV7	R
BI 10	SV8	SV8	R
BI 11	ST1	ST1	R
BI 12	ST2	ST2	R
BI 13	ST3	ST3	R
BI 14	SV8B	SV8B	R
BI 15	SV9	SV9	R
BI 17	HEATER 1	HEATER 1	R

Object ID	Object Name	Current Value Description/Notes	R/W
BI 18	HEATER 2	HEATER 2	R
AI 1	Ambient Temperatur	Ambient temperature in °C	R
AI 2	Compressor 1 Freq	Compressor 1 frequency in Hz	R
AI 3	Compressor 2 Freq	Compressor 2 frequency in Hz	R
AI 4	Compressor 1 Discharge Temp	Compressor 1 discharge temperature in °C	R
AI 5	Compressor 2 Discharge Temp	Compressor 2 discharge temperature in °C	R
AI 6	High Pressure	High pressure for compressor in bar	R
AI 7	Low Pressure	Low pressure for compressor in bar	R
AI 8	Malfunction Code	Error Code (see 6.4)	R
AI 9	Fan 1 Speed	Fan speed for Fan 1	R
AI 10	Fan 2 Speed	Fan speed for Fan 2	R
AI 11	T3	T3 in °C	R
AI 12	T3B	T3B in °C (reserved)	R
AI 13	Version	Software Version	R
AI 14	Outdoor type	Outdoor type	R
AI 15	Outdoor Horses	Outdoor Horses	R
AI 16	Exv1 opening	Exv1 opening	R
AI 17	Exv2 opening	Exv2 opening	R
AI 18	Exv3 opening	Exv3 opening	R
BV 1	Emergency Stop	(reserved) 0 - emergency stop OFF; 1 - emergency stop ON	R

6.3 Object List for HTHM Units

The BACnet device for each HTHM unit provides the following objects:

Object ID	Object Name	Current Value Description/Notes	R/W
AV 50	Water Heating Temperature Setting	Heating-water temperature setting, unit is °C, range is 25-80.	RW
AV 51	Heating Temperature Setting	Heating temperature setting, unit is °C, range is 25-80.	RW
AV 52	Heating Temperature Lock	The current value, "0", indicates that the limit of the heating temperature is unlocked, "25~80°C" indicates the upper limit of the Heating temperature, "254" indicates the temperature non-adjustable.	RW
AV 53	Water Heating Temperature Lock	The current value, "0", indicates that the limit of the Heating-water temperature is unlocked, "25~80°C" indicates the upper limit of the Heating-water temperature, "254" indicates the temperature non-adjustable.	RW
AV 60	Water Inlet Temperature	Water Inlet Temperature in °C	R
AV 61	Water outlet Temperature	Water outlet Temperature in °C	R
AV 62	Water Tank Temperature	Water Tank Temperature in °C	R
AV 63	Error Code	Error Code (see 6.4)	R
AV 64	Tf	Tf temperature in °C	R
AV 65	T2A	T2A temperature in °C	R
AV 66	T7	T7 temperature in °C	R
AV 67	T7C	T7C temperature in °C	R
AV 68	Pe	Pe in bar	R
AV 69	Pc	Pc in bar	R
AV 70	EXV 1	EXV 1 opening	R
AV 70	EXV 1	EXV 1 opening	R

Object ID	Object Name	Current Value Description/Notes	R/W
AV 71	EXV 2	EXV 2 opening	R
AV 72	Need	HTHM need	R
AV 73	Power	Power	R
AV 75	Compressor Frequency	Compressor Frequency(Hz)	R
AV 76	Software Version	Software Version	R
MV 78	Heating Lock	1 – Lock ON; 2 – Lock OFF; 3 - Unlock	RW
MV 79	Heating-water Lock	1 – Lock ON; 2 – Lock OFF; 3 - Unlock	RW
MI 56	Current Mode	1 - Off; 4 – Heating;6- Water Heating;	R
BV 90	Heating On/Off	0 - OFF; 1 - ON	W
BV 91	Water Heating On/Off	0 - OFF; 1 - ON	W

6.4 Error Code

Error Code	Corresponding Error
0	No error
1~20	A0~AF, AH, AL, AP, AU
21~40	b0~bF, bH, bL, bP, bU
41~60	C0~CF, CH, CL, CP, CU
61~80	E0~EF, EH, EL, EP, EU
81~100	F0~FF, FH, FL, FP, FU
101~120	H0~HF, HH, HL, HP, HU
121~140	L0~LF, LH, LL, LP, LU
141~160	J0~JF, JH, JL, JP, JU
161~180	n0~nF, nH, nL, nP, nU
181~200	P0~PF, PH, PL, PP, PU
201~220	r0~rF, rH, rL, rP, rU
221~240	t0~tF, tH, tL, tP, tU
241~260	U0~UF, UH, UL, UP, UU
Reserved	

Notes:

- 1) A0~AF refers to A0, A1, A2, A3, A4, A5, A6, A7, A8, A9, AA, AB, AC, AD, AE, AF, etc.
- 2) In cases where the error code displayed does not reflect the error affecting the machine, the machine's actual error should be given priority. The specific meaning of the error code is based on the interpretation of the service manual.

PART 3. M-interdace FUNCTION OVERVIEW

1 Select Language

The language selection interface appears only when the unit is powered on for the first time and no language has been selected.



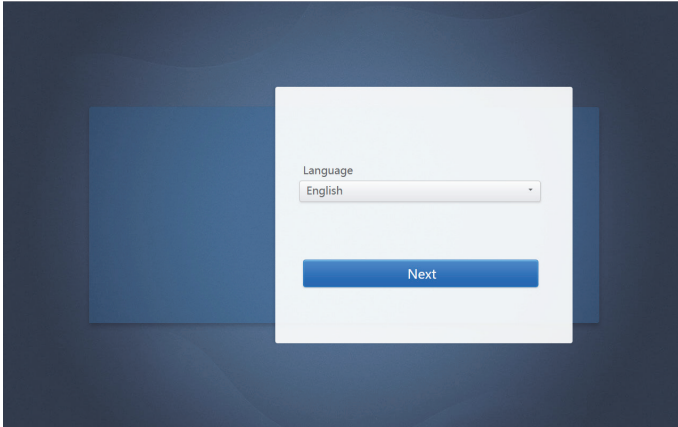

Note: The language can be changed later in the Settings menu.

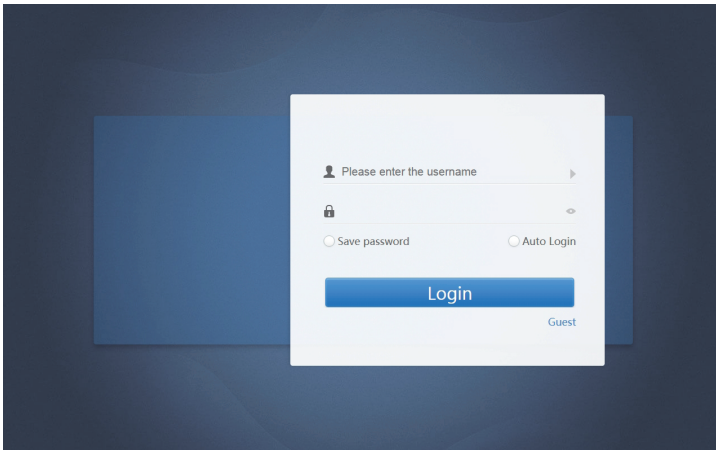

2 Login

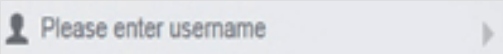
(Features in this section on the Web terminal and touch-screen are consistent. The "Save Password" may be available depending on the browser you used.)



Username	
Password	
Save password	<input type="radio"/> Save Password <input checked="" type="radio"/> Save Password
Auto login	<input type="radio"/> Auto Login <input checked="" type="radio"/> Auto Login
Login	
Guest login	
Default account name	normal
Initial password	123456

3 Home Page

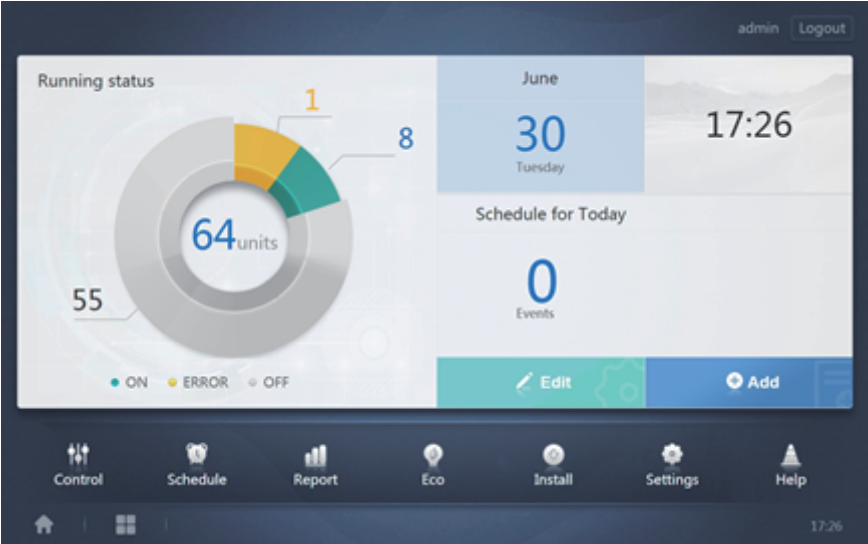

Default software display page once you have logged in successfully:

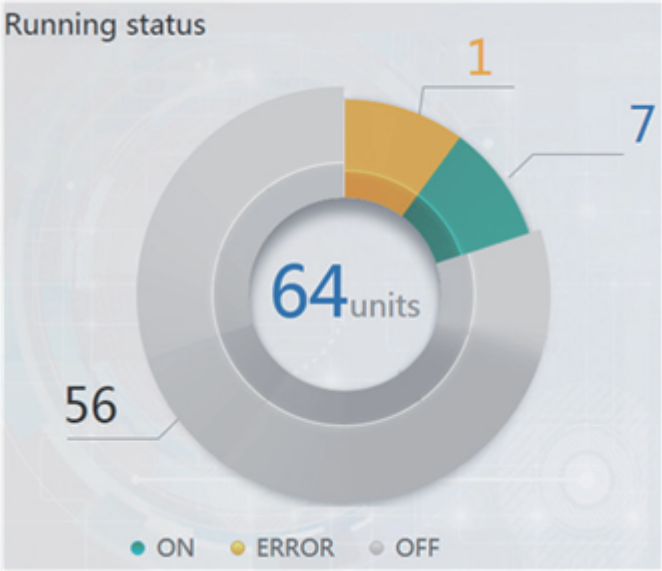

3.1 Overview of Indoor Unit Running Status

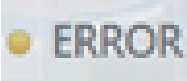

This section classifies the status of the indoor units into the following three categories:

Running	
Error (Error includes error and offline)	
Off	

3.2 Device Status List

Tap "Indoor Unit Status Statistics" to display the device status list.

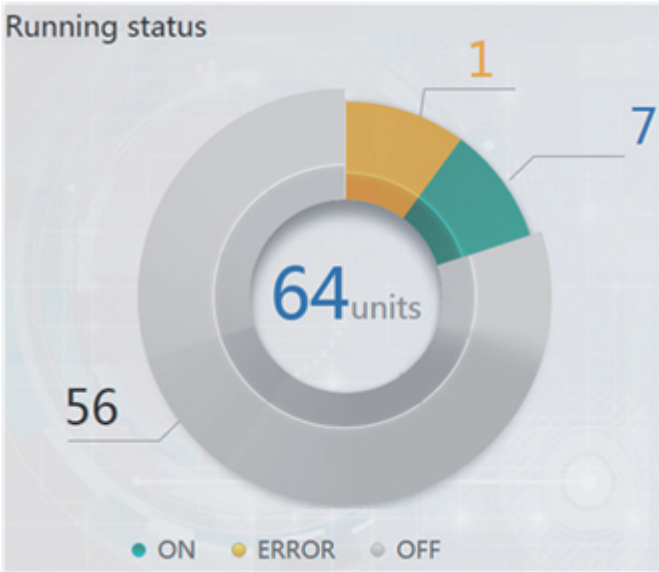

Indoor Unit Status Statistics

IDU		ODU		HTHM							
Name	ID	Type	Group No.	Mode	Setpoint	C Setpoint	H Setpoint	Fan	Room temp.	Error code	
idu-2-0-00	2-0	0	0	Cool	19	--	--	M	20	--	
idu-2-0-01	2-1	0	0	Heat	19	--	--	M	20	--	
idu-2-0-02	2-2	0	0	Dry	19	--	--	M	20	--	
idu-2-0-03	2-3	0	0	Fan	--	--	--	M	20	--	
idu-2-0-04	2-4	5	0	Cool	19	--	--	M	20	--	
idu-2-0-05	2-5	5	0	Heat	19	--	--	M	20	--	
idu-2-0-06	2-6	1	0	Heat	--	--	--	--	20	E4	
idu-2-0-07	2-7	5	0	Heat	19	--	--	Off	20	--	
idu-2-1-08	2-8	21	0	OFF	--	--	--	--	-25	--	
idu-2-1-09	2-9	21	0	OFF	--	--	--	--	-25	--	

1 / 6

11:22 PM

IDU		ODU		HTHM						
Name	ID	Mode	Error code	Ambient temp.	FAN1	FAN2	kWH	Power	Demand	Mode Priority
odu-2-0-00	2-0	Heat	--	10	10	44	0	8	2	Auto
odu-2-0-01	2-1	Heat	--	80	10	10	0	10	2	Auto
odu-2-0-02	2-2	Heat	--	80	10	44	0	13	2	Auto
odu-2-0-03	2-3	Heat	--	80	10	10	0	30	2	Auto
odu-2-1-04	2-4	OFF	H2	20	--	--	0	10	2	Auto
odu-2-1-05	2-5	OFF	--	20	--	--	0	13	2	Auto
odu-2-1-06	2-6	OFF	--	20	--	--	0	13	2	Auto
odu-2-1-07	2-7	OFF	--	20	--	--	0	13	2	Auto
odu-2-2-08	2-8	Heat	--	20	10	10	0	20	2	Auto
odu-2-2-09	2-9	Heat	--	20	10	10	0	15	2	Auto

1 / 4

11:23 PM

IDU		ODU		HTHM				
Name	ID	Type	Group No.	Mode	H Setpoint	WH Setpoint	Water inlet temp.	Water outlet temp.
idu-2-7-60	2-60	17	0	OFF	--	--	-25	-25
idu-2-7-61	2-61	17	0	OFF	--	--	-25	-25
idu-2-7-62	2-62	17	0	WH	25	25	90	90
idu-2-6-63	2-63	17	0	OFF	--	--	90	90

1 / 1

11:23 PM

Scroll through the interface horizontally to check more parameters of the IDU, ODU, and HTHM.

3.3 Function Menu

Navigate through all the functions at the bottom of the home page;

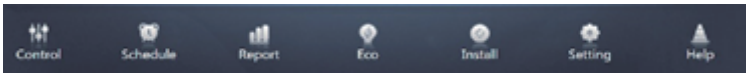

3.4 Special Menu



Function	Icon
Back to Home	
Operating History	

Note: The interface response time may lag if users query a long period of operation history.

4 Control



Control



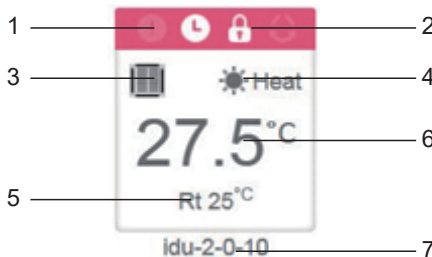

Function	Inactive	Active
Indoor Unit View - Group		
Indoor Unit View - System		
Indoor Unit View - Map		

Select "Group" to view information of the corresponding indoor unit on the right. A series of icons are displayed, and the details are as follows.













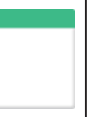

No.	Description
1	The colours here represent the operating modes. For details, refer to the Table of Basic Mode Images.
2	Indicators (in order from left to right): error, schedule, lock, swing. Icon is white when active, such as the lock indicator in the figure.
3	Displays the corresponding device model. For details, refer to the Model Table.
4	The icons here represent the operating modes. For details, refer to the Table of Basic Mode Images.
5	Ambient temperature
6	Set temperature
7	You can change the indoor unit name on the "Install" page.



















Note: The error code shown in the indoor unit on the old platform is different from the error code shown in the nixie tube display of the indoor unit.

Function	Remarks
	Error
	Schedule
	Lock
	Swing

Basic Mode Images

Off, Error, Offline (grey)	Auto (dark blue)	Cool, EXCH (light blue)	Heat, BYP (red)	WH (orange)	Fan, FREE (green)	Dry, (yellow)
						
						

Model:

Old IDU	
4-Way Cassette (4-WAY)	
Wall-mounted	
Medium Static Pressure Duct (M-Duct)	
Low Static Pressure Duct (L-Duct)	
Air Handling Unit (AHU)	
High Static Pressure Duct (H-Duct)	
Compact 4-Way Cassette (COMPACT)	
Ceiling & Floor	
Vertical Type Concealed	
1-Way Cassette	
2-Way Cassette	
Fresh Air Processing Unit	
HRV	
IDUs in Wired Controller Group	
HTHM	
Floor standing unit	
AHU	 

When the refrigerant system supports the use of auto mode for dual setpoints, a small horizontal bar will appear below the model icon, e.g.:

4-Way Cassette (4-WAY)		
------------------------	---	---

4.1 Indoor Unit View - Group

Note: The group interface has a default "Ungrouped". All the devices that have not been assigned a group are included here.

The user defined groups are shown on the left of the device monitor page. Once a group is selected, the indoor units of the selected group are shown on the right.

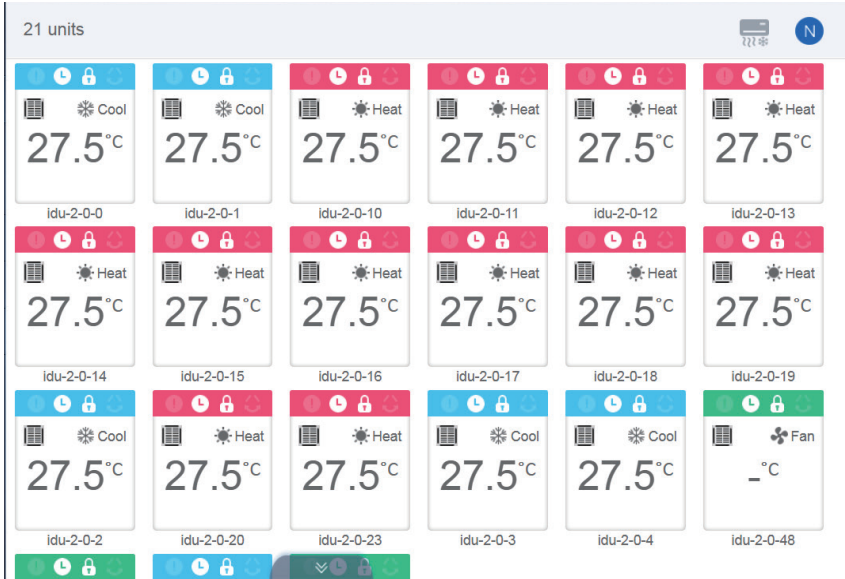

The top left corner shows the number of indoor units in the group.

4.1.1 Order of Display for Indoor Unit

Indoor units can be sorted by name or mode.

Function	Inactive	Active
Sort by mode Auto, Cool, Heat, Dry, Fan, Off, Error, Offline		
Sort by name		

4.1.2 General Controls for Indoor Unit

Tap to select the indoor unit and change its status to "selected".

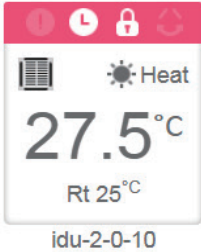

At the top left corner, you will see "All", "Control", and "Cancel".

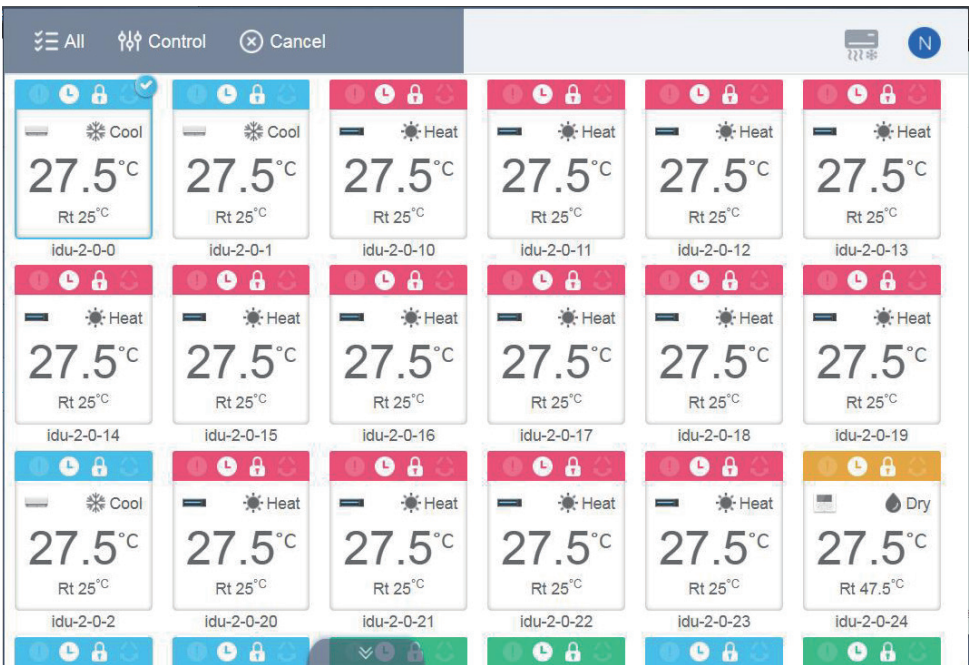

Tap "All" to select all the indoor units on the interface. If you tap an indoor unit after "All" is selected, the indoor unit will be unchecked, and "All" will change to normal mode. If Cancel is selected, all indoor units will be unchecked.

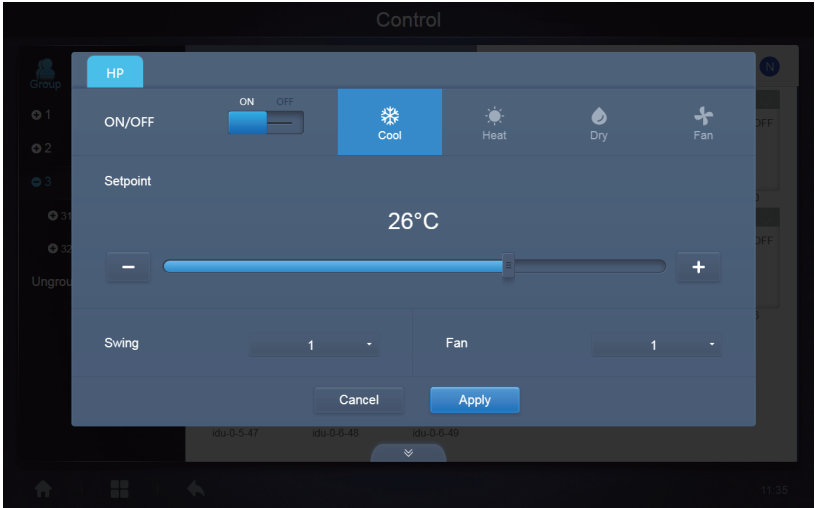

When simultaneously controlling multiple indoor units:

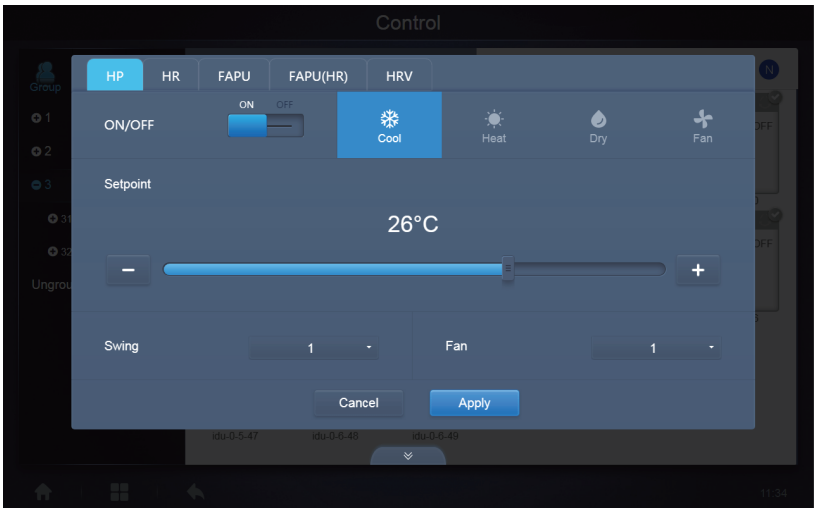

4.2 Indoor Unit View - System

This is similar to "Group Navigation", except that the system (instead of the groups) is on the left. System name is default and cannot change.



5 Schedule

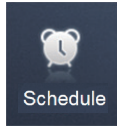

Once you have tapped **Schedule** on the Home Page to go to the function module, go to the page to view the schedules.

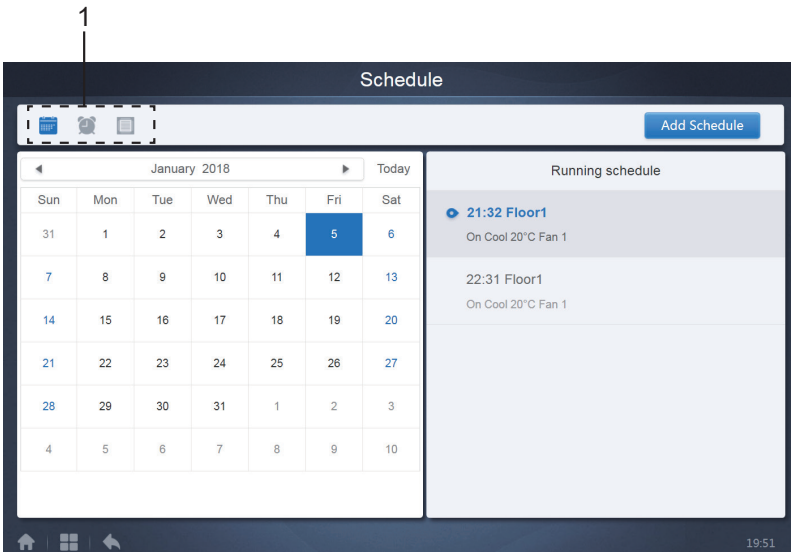

No.	Functions
1	<p>From left to right, the respective corresponding options to display the schedule are:</p> <ol style="list-style-type: none"> 1. Calendar View (by date); 2. Plan View (by plan); 3. Device View (by device); <p>Tap the corresponding icon to go to the respective schedule view. Default is the calendar view.</p>

Note: Different types of indoor units cannot be added to the same schedule.

5.1 View Schedule

5.1.1 Calendar View

With the calendar view, select the date on the left to retrieve and view the schedule corresponding to the selected date on the right.

The screenshot shows a calendar for January 2018 with the 5th of the month selected. To the right, the 'Running schedule' panel displays the following information:

- 21:32 Floor1**
On Cool 20°C Fan 1
- 22:31 Floor1**
On Cool 20°C Fan 1

Calendar View

The diagram illustrates the calendar view interface with the following callouts:

- 1**: Points to the left navigation arrow.
- 2**: Points to the month/year header 'January 2018'.
- 3**: Points to the right navigation arrow.
- 4**: Points to the 'Today' indicator.
- 5**: Points to the date '10' in the calendar grid.
- 6**: Points to the date '25' in the calendar grid.
- 7**: Points to the date '4' in the calendar grid.

Calendar view

No.	Functions
1	Tap to shift the calendar to display the previous month.
2	Displays the year and month information of the current date.
3	Tap to shift the calendar to display the next month.
4	Tap to quickly jump to the month that today's date belongs to, and select today's date.
5	Today's date that has not been selected (light blue background). Tap to select this date.
6	Date selected (dark blue background).
7	The grey numbers are dates not in the month shown now. Tap to jump to the month that the date belongs to.

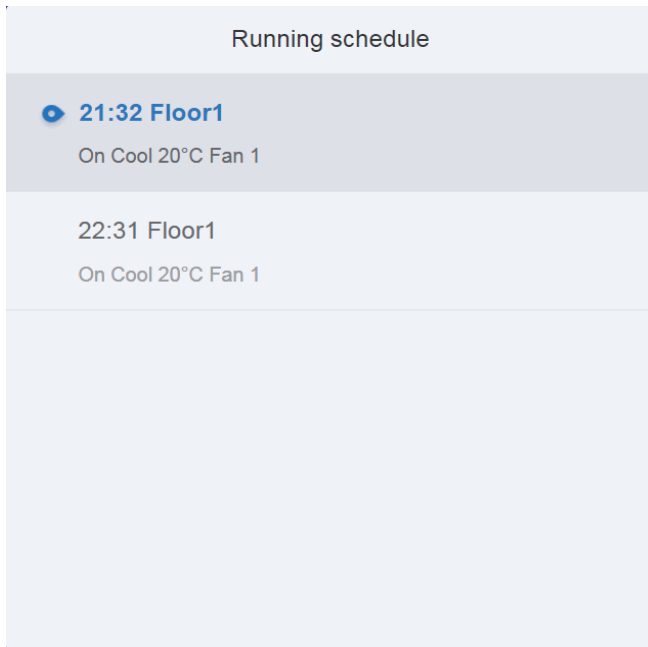

Schedule view

The schedule page only shows scheduled tasks that have not been performed for the selected date (arranged in the order of implementation time). The displayed information is as follows.

1. Time
2. Schedule name
3. Details of the executed command (On/off, mode, set temperature, fan speed)

5.1.2 Plan View

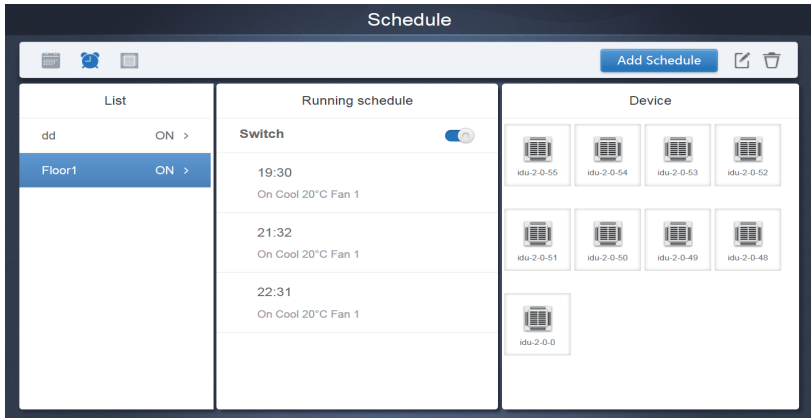

Tap the second icon to view the schedule by plan as shown in the figure above.

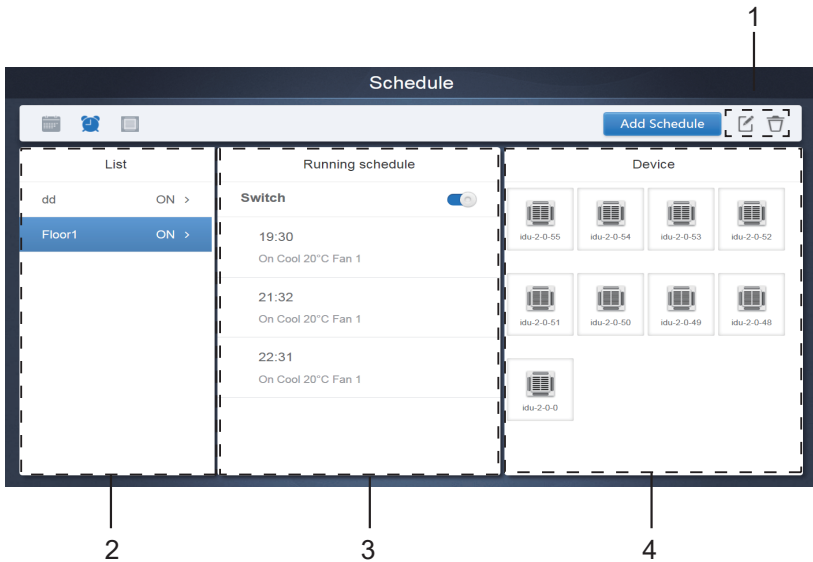

Calendar view (part)

No.	Functions
1	Tap the left icon to go to the schedule editor. Tap the right icon to delete the selected schedule.
2	The schedules are arranged in order of their time created. Tap to select the schedule you need. Selected schedule has a blue background colour. The schedule name is on the left of the schedule bar, and the status (ON/OFF) of the schedule is on the right.
3	Shows all the timings for the selected schedule. Use the On/Off slider to perform on/off operations on the schedule. All the events on the dates of the schedule that has been turned off are not implemented, and the status "OFF" is displayed on the schedule bar. The schedule will not come into effect until it is turned on again.
4	Shows all the indoor units associated with the schedule.

5.1.3 Device View

Tap the third icon to go to the device view.

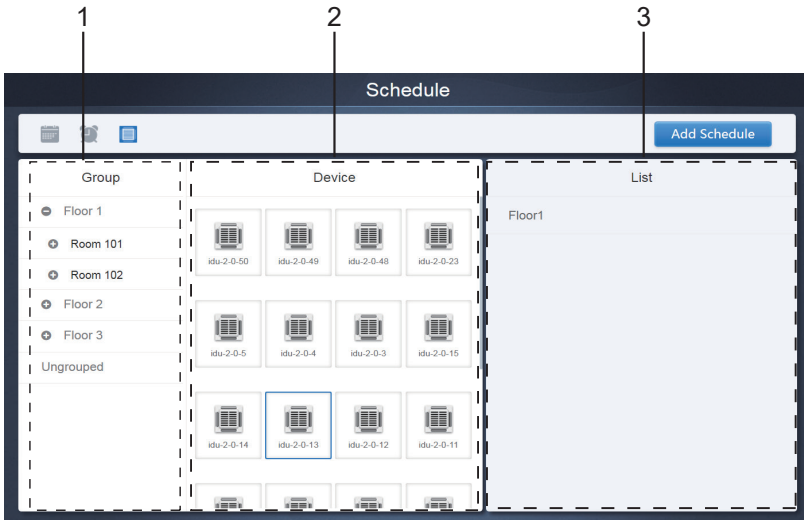

The page is divided into three sections.

1. Group list: this makes it easy to locate the device quickly. Tap "+" to expand the group, and "-" to fold the group. All the IDUs in the selected group are displayed in the second column. Tap "Ungrouped" to view devices that have not been grouped.
2. The second column is a list of all the devices in the selected group.
3. The third column is the list of schedules, and displays names of all the schedules associated with the selected device.

5.2 Add Schedule

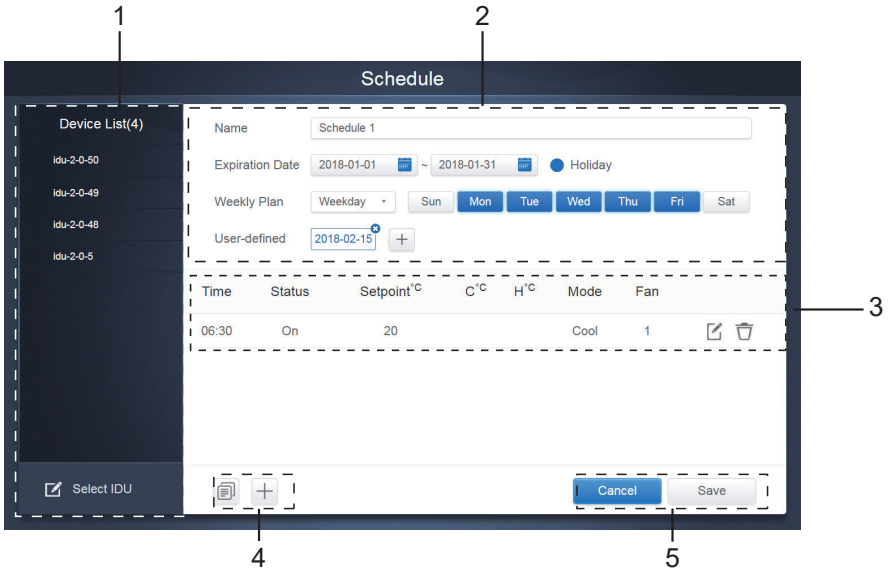

No.	Functions
1	The device list displays all the devices related to the schedule. Tap to select and add the IDU.
2	Settings related to the schedule name and effective date.
3	Settings related to the timings and commands.
4	Copy and add the schedule timings.
5	Cancel and save

5.2.1 Add Device

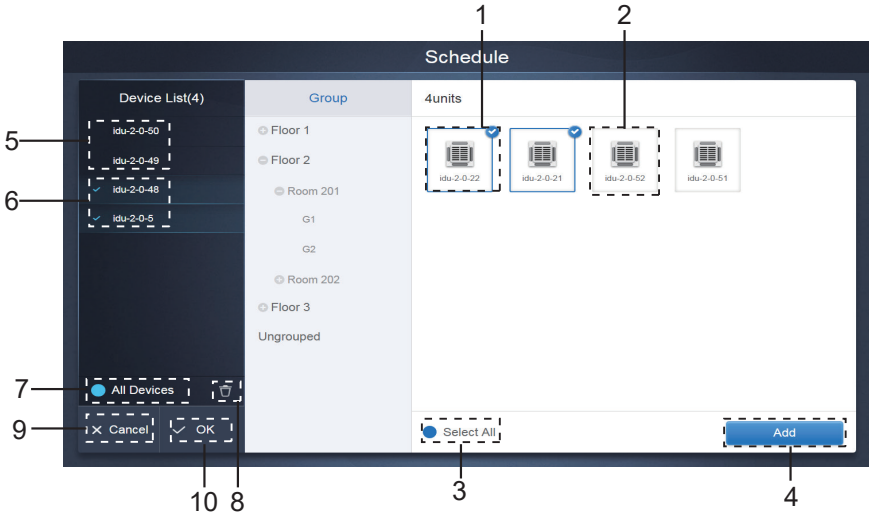

Device Selection Page

No.	Functions
1	Devices waiting to be selected are displayed in the rightmost area, and these are the devices that have not been added to the selected subgroup. "1" is a selected device and its top right corner is marked with
2	"2" is a device that has not been selected. Tap the unselected device to select the device. Tap again to deselect the selected device.
3	Tap to activate "Select All". is an active status. After activation, all the devices waiting to be selected in the group are selected. Tap again to deselect all. Manually cancel the selected status of a few devices after "Select All" has been activated will not cancel "Select All". Tap again to cancel the "Select All" option.
4	Tap to add the selected device.
5	Displays the device that has been added. Tap to select this operation. "5" is a device that has not been selected, tap to select it.
6	Displays the device that has been added. Tap to select this operation. "6" is a selected device, tap to deselect it. Left of the selected device is marked with
7	Tap to activate "Select All". is an active status. After activation, all the devices waiting to be selected in the group are selected. Tap again to deselect all. Manually cancel the selected status of a few devices after "Select All" has been activated will not cancel "Select All". Tap again to cancel the "Select All" option.
8	Move the device that has been selected to be added to the group out of the "Add device" queue.
9	Exit without saving.
10	Save and exit.

5.2.2 Date Settings

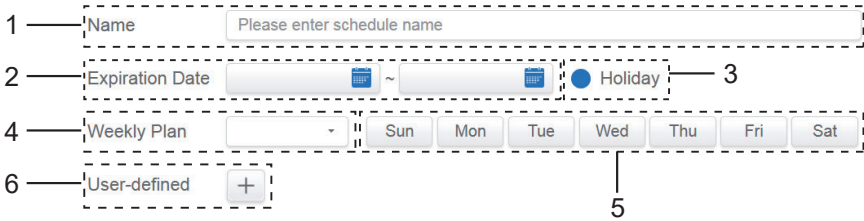

No.	Functions
1	Tap the input box to enter a name. Maximum length is 80 English characters (40 Chinese characters). Note that system is unable to save the name if it contains the following symbols: ([~!#\$%^&*()= {}';:,.<.>/...?~! ¥... () — 【】 " : " " ° , \ ? ; <<>])
2	Tap in the white space next to the blue icon on the left to activate the date selection dialog box. Tap to select the corresponding dates, the start date is on the left and the end date is on the right. The end date cannot be earlier than the start date.
3	Check the blue icon on the left next to Holiday to activate the holiday exception function which is to carry out all the plans in the schedule during the holiday period. The icons that are checked are active.
4	Quick select for the weekly plan. Select the particular Friday to implement the plan for the day. If the day falls on a working day (Mon to Fri), the schedule for the day is implemented on the day itself.
5	Manual option for weekly plan. Tap the date to activate or deactivate it. Blue indicates active status, while white indicates inactive status.
6	You can add a custom date to the schedule as an individual date. Tap the "+" sign to add a date each time, and you may add up to 5 dates. Tap once to select and add the date. Tap "x" at the top left corner to delete this date. Tap the date in other areas to deselect it.



Note:

The schedule will not be implemented during holidays unless Holiday is selected;

The schedule on the custom date will be implemented, regardless of whether the custom date falls within the effective dates, weekly plan or holidays;

The schedule for the remaining dates must meet the requirements of the effective dates and weekly plan.

5.2.3 Add Schedule Command

Tap  to display the dialog box for adding scheduled commands. The following types of schedule command interfaces will be displayed according to the selected indoor unit type (you must add indoor units before creating a schedule command). After the first schedule command is created, you can tap  to create a schedule command.

1. Heat pump

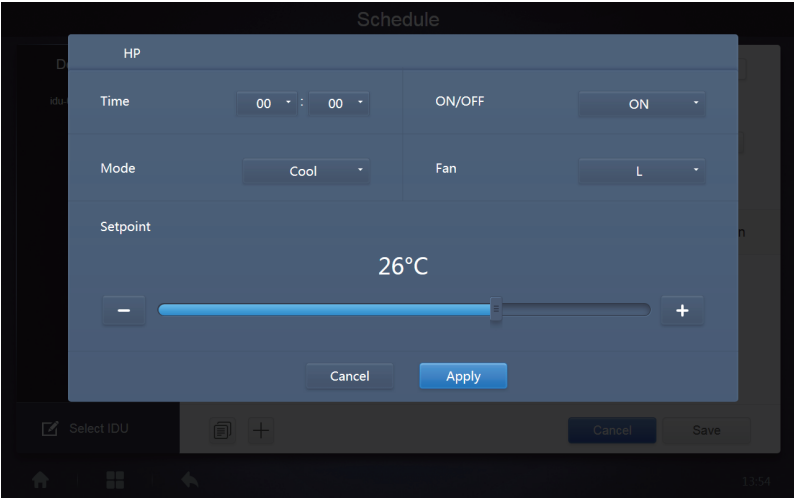

2. Heat recovery

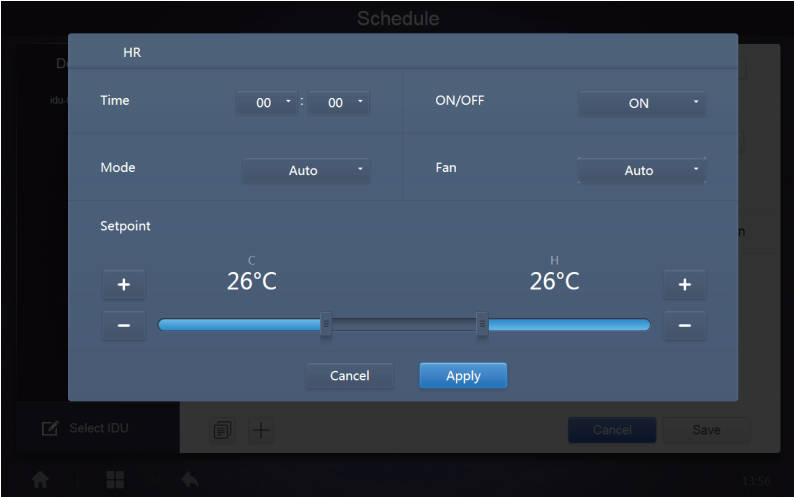

3. FAPU

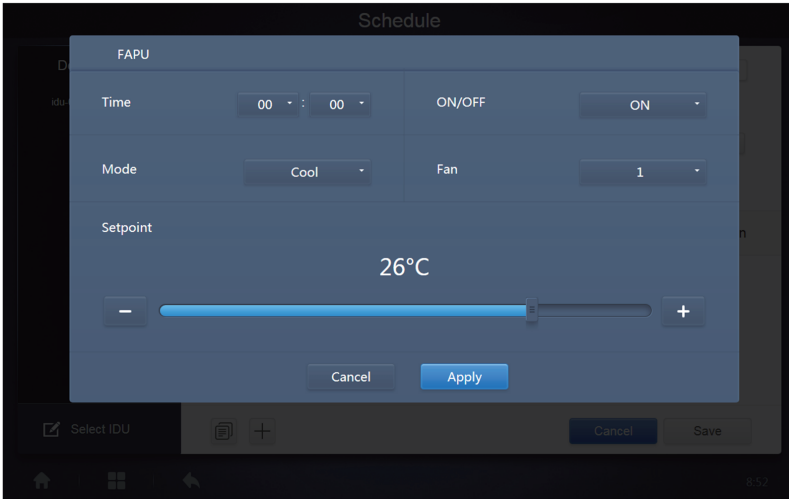

4. FAPU(HR)

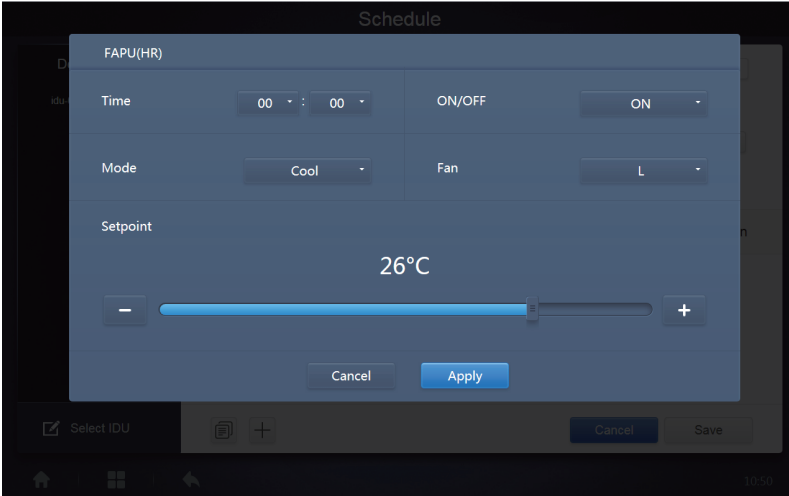

5. HTHM

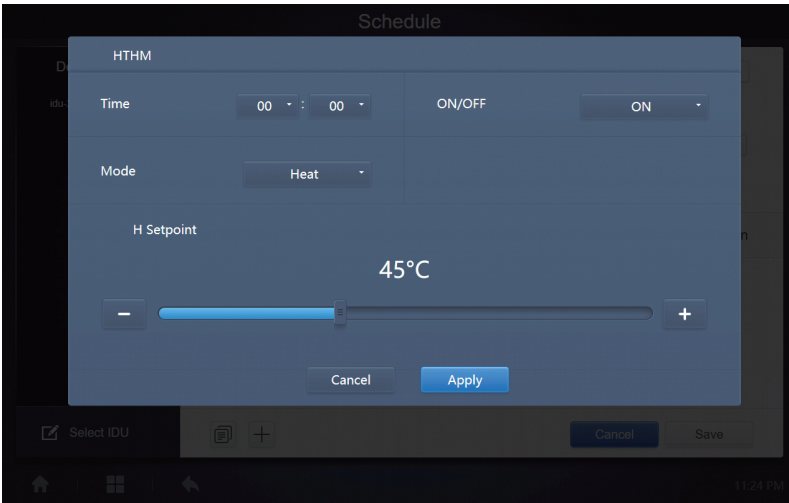

6. AHU

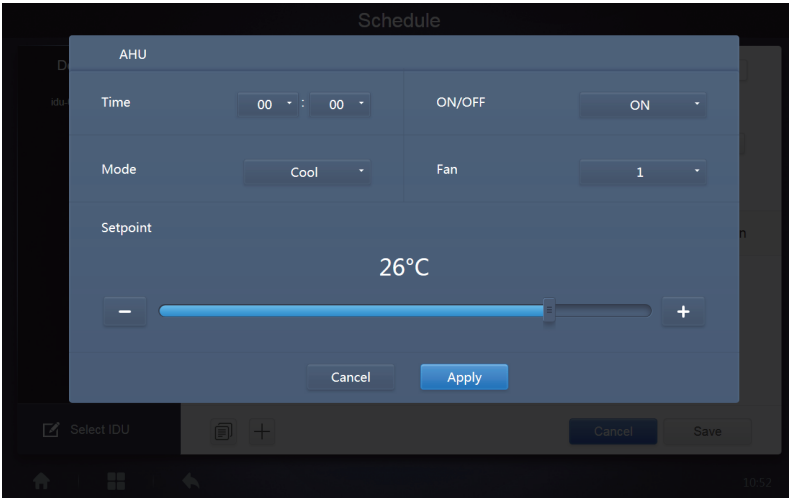

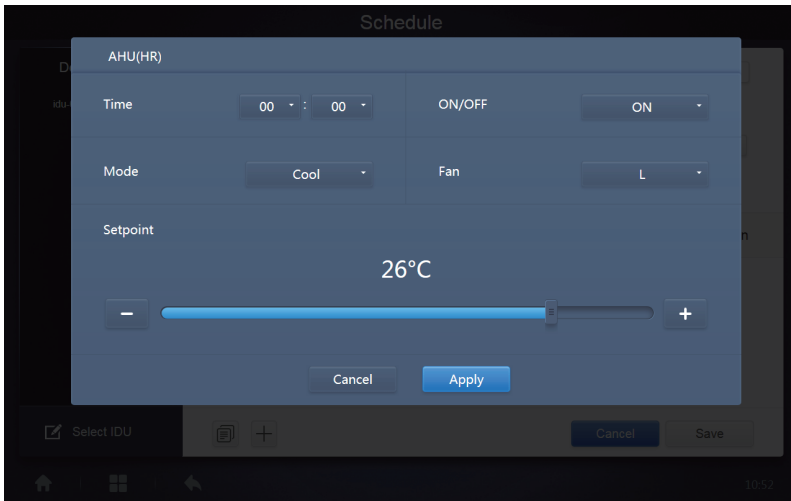

7. AHU (HR)



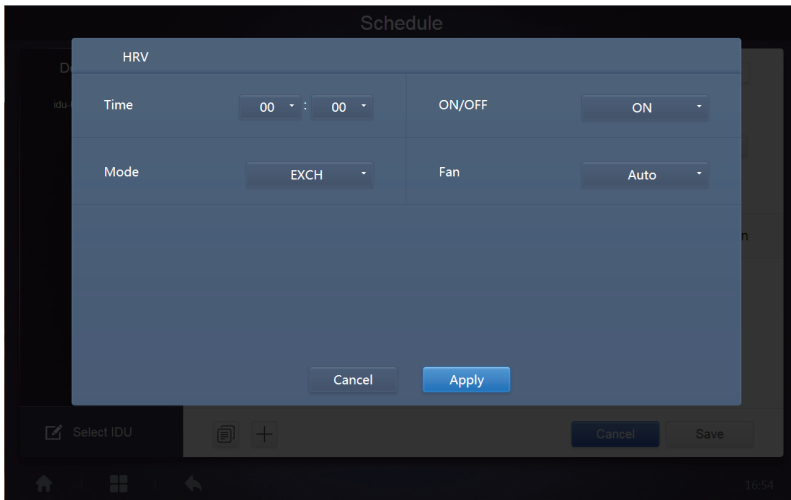

8.HRV



Note:

1. Tap "+" or "-" on "Setpoint" to increase or decrease the temperature by 0.5/1 (corresponding parameters are configured in settings);
2. Tap "+" or "-" on "Time" to increase or decrease the time by 1;
3. Tap  to copy the task with the latest implementation time and add one more minute to the implementation time. The 23:59 command cannot be copied.
4. For the times that have been saved, tap  to edit again, and  to delete.

Time	Status	Setpoint°C	C°C	H°C	Mode	Fan		
06:30	On	20			Cool	1		



Note: The time on the schedule command editing interface is fixed to the 24 hour system. The homepage display interface can be set to display the 24 or 12 hour system.

5.2.4 Save

Tap "Save" to save all the operations on this page, and open a new schedule to add pages. If there are illegal or incomplete items, you will receive the corresponding prompts.

Tap "Cancel" to cancel all operations to add this schedule, and exit to the calendar view for the schedule.

5.2.5 Change Schedule

Tap  on the Home Page or tap  on the schedule in the calendar view to change the schedule. On the Home Page, the schedule is marked by . On the schedule view page, the entry point is the selected schedule.

The operating method for the schedule editor is similar to that for adding a new page. The difference is that the screen will remain on the schedule editor page for "Save".

6 Report

(Files are exported to local folder when the software is opened on a Web terminal.)

On the Home Page, tap  .

There are 3 modules for users to choose from:

1. Operating Duration
2. Running Record
3. Energy Statistics

Tap the corresponding key to enter the module.



6.1 Operating Duration

Operating duration report: View the total operation duration of the IDUs within a specified time period. Note: The schedule report and energy consumption report can be queried only after this function is enabled.

Note: The power data and running time data of the previous hour are generated at the turn of each new hour.

6.1.1 Query Operating Duration

Name	Date	Total	C run
idu-2-0-50	2018-01-05	6930	0
idu-2-0-49	2018-01-05	6930	0
idu-2-0-48	2018-01-05	6930	0
idu-2-0-23	2018-01-05	6930	0
idu-2-0-5	2018-01-05	6930	27







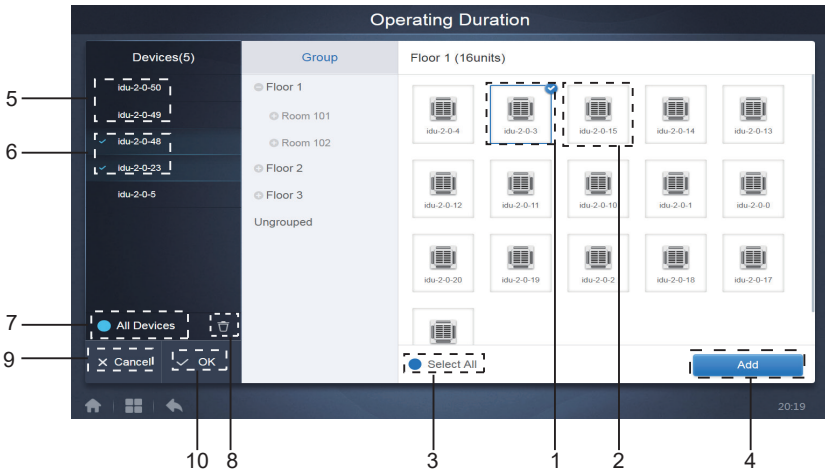

Operating Duration

6.1.2 Operating Procedures

1. Tap the selected device to go to the device selection page.
2. Details of the device selection page are as follows:



Device Selection Page

No.	Functions
1	Devices waiting to be selected are displayed in the rightmost area, and these are the devices that have not been added to the selected subgroup. "1" is a selected device and its top right corner is marked with  .
2	"2" is a device that has not been selected. Tap the unselected device to select the device. Tap again to deselect the selected device.
3	Tap  to activate "Select All".  is an active status. After activation, all the devices waiting to be selected in the group are selected. Tap again to deselect all. Manually cancel the selected status of a few devices after "Select All" has been activated. Will not cancel "Select All". Tap  again to cancel the "Select All" option.
4	Tap to add the selected device.
5	Displays the device that has been added. Tap to select this operation. "5" is a device that has not been selected, tap to select it.
6	Displays the device that has been added. Tap to select this operation. "6" is a selected device, tap to deselect it. Left of the selected device is marked with  .
7	Tap  to activate "Select All".  is an active status. After activation, all the devices waiting to be selected in the group are selected. Tap again to deselect all. Manually cancel the selected status of a few devices after "Select All" has been activated will not cancel "Select All". Tap  again to cancel the "Select All" option.
8	Move the device that has been selected to be added to the group out of the "Add device" queue.
9	Exit without saving.
10	Save and exit.

3. Perform the time selection once the device has been added.

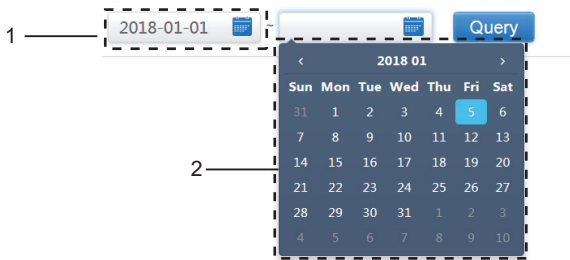

Time Selection Page

No.	Functions
1	Tap in this area (except the blue calendar icon) to activate the calendar.
2	Tap any number to select the date. Selected date in the box has a light blue background, otherwise today's date is selected. The grey text is a date that is outside this month. Tap to select it. Tap the time at the top to quickly locate the date. Tap once to go to the quick selection function for the month. Tap twice to go to the quick selection function for the year. Use the arrows on both sides at the top to quickly toggle the year and month. Each toggle is a 12-year duration for quick selection of year, 1-year duration for quick selection of month, and 1-month duration for quick selection of date. Tap the left arrow to move to previous month or year, and the right arrow to move to the next month or year.

Note: You cannot select an HTHM and a common IDU at the same time for query. Items on the list of an HTHM differ from those on the list of a common IDU.

6.2 Running Record

The running record also needs to satisfy two conditions before the query is implemented. The operating procedures and query method are similar to 6.1.2 Operating Duration.

Running Record

Devices(62)
 idu-0-0-00
 idu-0-0-01
 idu-0-0-02
 idu-0-0-03
 idu-0-0-04
 idu-0-0-05
 idu-0-0-06
 idu-0-0-07
 idu-0-1-08
 idu-0-1-09

2019-01-01
2019-01-31
Query



Operating Duration	Name	ID	Type	Group NO.	Mode	Setpoint	C Setpoint
2019/01/31 16:33:45	idu-0-0-00	0-0	0	0	OFF	--	--
2019/01/31 16:12:06	idu-0-0-00	0-0	0	0	OFF	--	--
2019/01/31 03:23:54	idu-0-0-00	0-0	0	0	OFF	--	--
2019/01/31 16:33:45	idu-0-0-01	0-1	0	0	Heat	19	--
2019/01/31 16:12:06	idu-0-0-01	0-1	0	0	Heat	19	--
2019/01/31 03:23:54	idu-0-0-01	0-1	0	0	Heat	19	--
2019/01/31 16:33:45	idu-0-0-02	0-2	0	0	Dry	19	--
2019/01/31 16:12:06	idu-0-0-02	0-2	0	0	Dry	19	--

First
Previous
1 / 5
Next
Last
Email
Export

Home
App
Back
4:36 PM

6.3 Energy Statistics

The method to query energy statistics is similar to that for the previous two functions. However, in the coordinate mode, you can only add up to three devices to search. There are no restrictions in the table mode.



Use    at the top right corner to select the different modes. The selected mode is blue. The three modes are histogram, line graph and table respectively.

6.3.1 List View

Energy Statistics

Devices(3)
 idu-2-0-55
 idu-2-0-54
 idu-2-0-53

2018-01-10
2018-01-10
Query

Name	ID	IDU Operating Power	IDU Standby Power	Total IDU Cost
idu-2-0-55	2-55	0	0	0
idu-2-0-54	2-54	0	0	0
idu-2-0-53	2-53	0	0	0

Add Dev.
Export

Home
App
Back
16:48

List View

6.3.2 Histogram and Graph

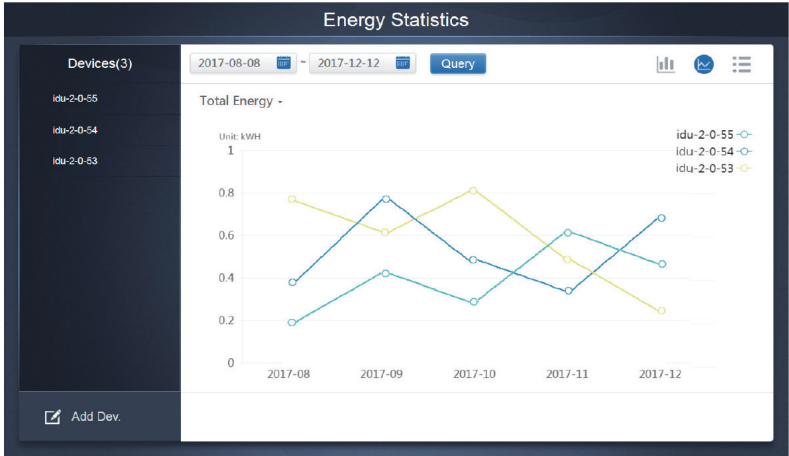

Line Chart

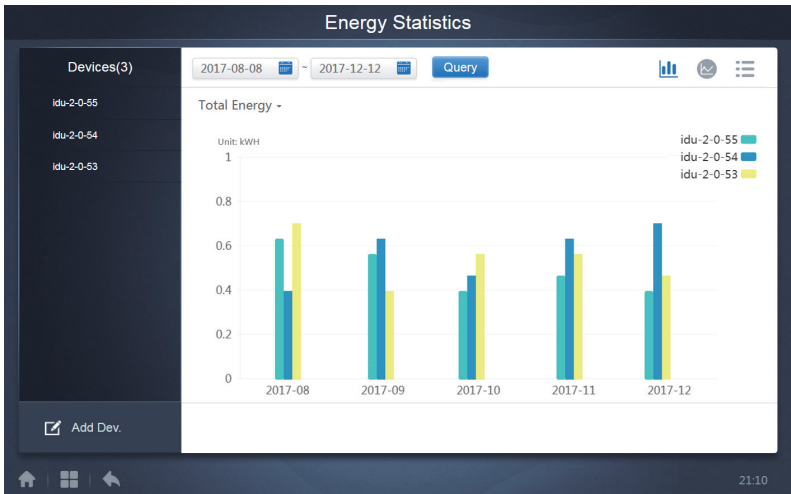

Histogram

For histograms and graphs, you can only select three objects, and select either IDU or refrigerant system. The selected time for graphs and lists is based on the month (effective graph is based on day). There are only two options in total energy: total energy, and operating energy.

In the graphs, histograms and tables, the optional parameters are "Total Energy" and "Operating Energy".

	Operating Energy	Total Energy
IDU	Operating Electricity	Operating electricity + standby power
ODU	Operating Electricity	Operating electricity + standby power + exceptional energy

6.4 Log

Tap  at the lower-left corner of the Home Page to go to the log page.

Time	Func.	Detail	Type	Device name	Username
2018/01/05 19:11:11	Login	Login	--	--	admin
2018/01/05 19:21:24	Login	Login	--	--	admin
2018/01/05 19:29:20	Login	Logout	--	--	admin
2018/01/05 19:29:54	Login	Login	--	--	admin
2018/01/05 19:30:05	Schedule	ON/OFF:On,Mode:Cool,Setpoint:20°C,Fan:1	IDU	64PCS(idu-2-0-0),idu-2-0-1,jdu-2-0...	admin
2018/01/05 19:47:23	Login	Login	--	--	admin
2018/01/05 19:51:18	Login	Login	--	--	admin
2018/01/05 20:28:08	Login	Login	--	--	admin
2018/01/05 20:29:20	Login	Login	--	--	normal
2018/01/05 20:35:36	Control	ON/OFF:On,Mode:Cool,Setpoint:26°C,Fan:Auto,SwingAuto	IDU	1PCS(idu-2-0-0)	normal
2018/01/05 20:35:39	Control	ON/OFF:On,Mode:Cool,Setpoint:26°C,Fan:Auto,SwingAuto	IDU	1PCS(idu-2-0-16)	normal

2018-01-05 ~ 2018-01-05 Query

Certain operations of the software are recorded in logs, and these are classified into the following categories:

- General control command
- ECO control command
- Schedule control command
- Login and logout

Select the start time and end time at the lower-left corner. Tap "Query" to display the log contents within this statistic compilation period.

Note:

When you switch the language, the language used to record the data in the schedule is not refreshed, and the log record is based on the data language at the time of creation.

6.5 Export Function

For Operating Duration, Running Record, and Energy Statistics reports, there are functions to export the queries records to .csv files (except for histograms and graphs). The contents of the exported files are consistent with the current results of the queries. The format of the file is .csv, and it can be viewed and edited with Excel. Naming convention of the exported file is:

- Operating Duration: running_timestamp.csv;
- Running Record: record_timestamp.csv;
- Energy Statistics: energy_timestamp.csv.

Running Record

Devices(21)

-

Query

Operating Duration	Name	Type	Group
2018/01/05 19:15:55	idu-2-0-23	1	
2018/01/05 19:14:24	idu-2-0-5	1	
2018/01/05 19:14:24	idu-2-0-4	1	
2018/01/05 19:14:24	idu-2-0-3	1	
2018/01/05 19:14:50	idu-2-0-15	1	
2018/01/05 19:14:50	idu-2-0-14	1	
2018/01/05 19:14:50	idu-2-0-13	1	
2018/01/05 19:14:50	idu-2-0-12	1	

Add Dev.

Email

Export

Home
Grid
Back
20:29

The export target is the default download path for the current browser .

7 Eco

Eco

IDU

ODU

- Floor 1
 - Room 301
 - Room 302
- Floor 2
- Floor 3
- Ungrouped

☰ All
⚙ Control
⏹ Cancel

Cool 27.5°C Rt 25°C idu-2-0-0	Cool 27.5°C Rt 25°C idu-2-0-1	Heat 27.5°C Rt 25°C idu-2-0-10	Heat 27.5°C Rt 25°C idu-2-0-11	Heat 27.5°C Rt 25°C idu-2-0-12	Heat 27.5°C Rt 25°C idu-2-0-13
Heat 27.5°C Rt 25°C idu-2-0-14	Heat 27.5°C Rt 25°C idu-2-0-15	Heat 27.5°C Rt 25°C idu-2-0-16	Heat 27.5°C Rt 25°C idu-2-0-17	Heat 27.5°C Rt 25°C idu-2-0-18	Heat 27.5°C Rt 25°C idu-2-0-19
Cool 27.5°C Rt 25°C idu-2-0-20	Heat 27.5°C Rt 25°C idu-2-0-21	Heat 27.5°C Rt 25°C idu-2-0-22	Cool 27.5°C Rt 25°C idu-2-0-23	Cool 27.5°C Rt 25°C idu-2-0-24	Fan -°C Rt -25°C idu-2-0-25

Home
Grid
Back
20:41

The ECO page has two parameters: IDU and ODU:
 The user groups are on the left, which is similar to the device monitor page, except that the control commands are different.

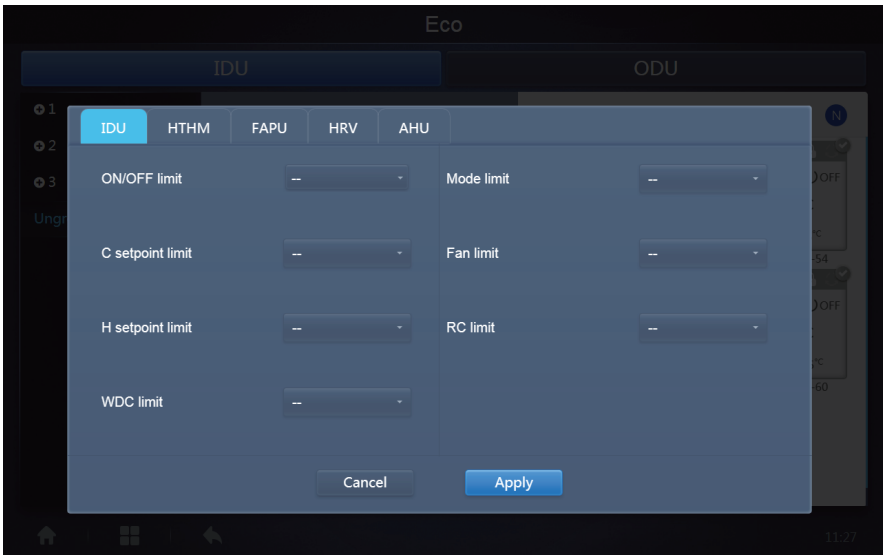

Certain indoor units may not support one or more locks described above. All parameters are "-" by default which means that no command is sent.

*Certain indoor unit models may not support all the lock functions mentioned above. Please consult the factory engineer on details regarding the different lock functions supported by different IDU models.

*Certain wired controllers may contain a "remote control/wired control, choose 1 of 2" function. This function is not related to the remote-lock in the TCONTWEBBAC02, and they are independent.

ODU:

Outdoor unit page directly displays ODU objects.

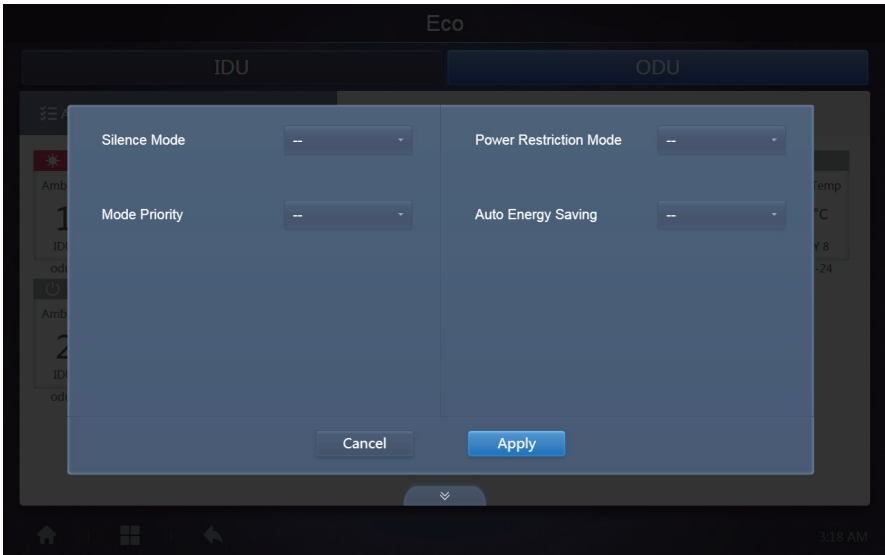

Certain outdoor units may not support one or more lock commands described above.

The TCONTWEBBAC02 can send any lock command to the outdoor unit. If the outdoor unit does not support the lock command, the outdoor unit will process the command based on its own logic. For details on the different lock functions supported by different outdoor units, refer to the function manual of the corresponding outdoor unit.

All parameters are "-" by default which means that no command is sent.

Definition	ODU Parameter	CCM-270B/WS Options
Silence Mode	0:Night silent time is 6h/10h (default)	8
	1:Night silent time is 6h/12h	9
	2:Night silent time is 8h/10h	10
	3:Night silent time is 8h/12h	11
	4:No silent mode	0
	5:Silent mode 1(only limit max. fan speed)	1
	6:Silent mode 2(only limit max. fan speed)	2
	7:Silent mode 3(only limit max. fan speed)	3
	8:Super silent mode 1(limit max. fan speedand compressor frequency)	4
	9:Super silent mode 2(limit max. fan speedand compressor frequency)	5
	A:Super silent mode 3(limit max. fan speedand compressor frequency)	6
	B:Super silent mode 4(limit max. fan speed and compressor frequency)	7
	F:Set silent mode via centralized controller (To use the software settings, the corresponding function dial code must be configured in the outdoor units)	
	Mode Priority	000:Auto priority (default)
001:Cooling priority		Cool Priority
010:VIPpriority or voting priority		VIP
011:Heating only		Heat Only
100:Cooling only		Cool Only
111: Set priority mode via centralized controller(To use the software settings, the corresponding function dial code must be configured in the outdoor units)		- (Message is 15. This parameter is not modified)
Power Restriction Mode	n41: Power limitation mode 1(Only available for the master unit, 100% capacity output)	Speed 0
	n42: Power limitation mode2(Only available for the master unit, 90% capacity output)	Speed 1
	n43: Power limitation mode3(Only available for the master unit, 80% capacity output)	Speed 2
	n44: Power limitation mode4(Only available for the master unit, 70% capacity output)	Speed 3
	n45: Power limitation mode5(Only available for the master unit, 60% capacity output)	Speed 4
	n46: Power limitation mode6Only available for the master unit, 50% capacity output)	Speed 5
	n47: Power limitation mode7(Only available for the master unit, 40% capacity output)	Speed 6
Auto Energy Saving	nb3::Exit auto power save mode	ON
	nb4:Enter auto power save mode	Off

8 Install

Under "Install", perform operations like device search, group edit, and name change when you use 10.1 for the first time.

8.1 Edit

Edit the name, model, fan power, auxiliary heating power (other parameters cannot be modified) of the indoor and outdoor units. Tap "Save" to save the edits.

The screenshot shows the 'Install' application interface. At the top, there are two tabs: 'Auto topo' and 'Manual topo'. Below the tabs is a table with the following columns: Bus, System, Addr., Type, Name, Fan(W), and EH(W). The table contains four rows of data:

Bus	System	Addr.	Type	Name	Fan(W)	EH(W)
Bus0 (0)	0	0	1	idu-2-0-0	0	0
Bus1 (0)	0	1	2	idu-2-0-1	0	0
Bus2 (96)	0	2	2	idu-2-0-2	0	0
Bus3 (0)	0	3	2	idu-2-0-3	0	0

Below the table, there are three labels: 'ICU', 'I due', and 'I duo'. At the bottom of the screen, a virtual keyboard is visible with various keys including letters, numbers, and symbols.

Note:

The acceptable range for the model is an integer from 0 to 12, and the model corresponds to the unit number in the device monitor.

The maximum values of the fan power and the auxiliary heating power must not exceed 65535, and must not be negative values.

The device name length cannot exceed 12 characters. Otherwise, you will receive a prompt that the name is ineligible. The device name cannot be duplicated.

8.2 Group

Tap  at the lower-left corner to go to the group editor from the installation page.

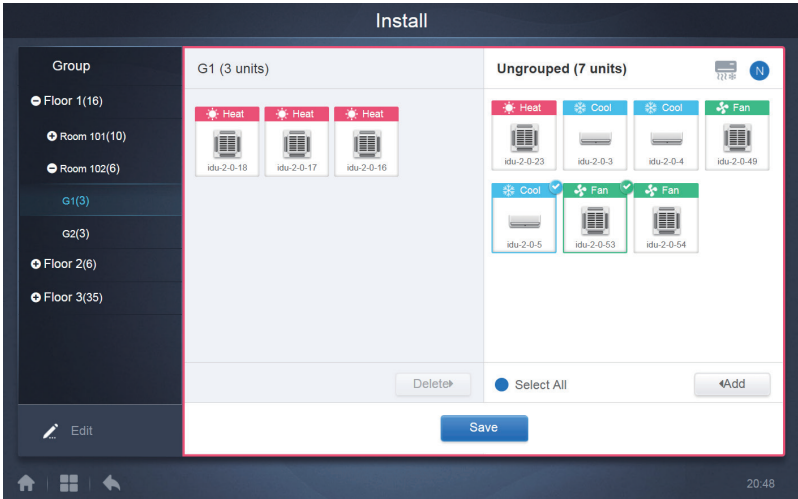

Group creation is on the left.

When a group is selected, the group and the indoor units in that group are shown in the middle. Indoor units that have not been grouped are shown on the left.

8.2.1 Create, Edit, and Delete Group

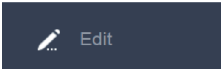

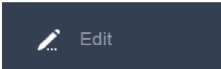
Tap  at the lower-left corner to go to the pages to create, edit and delete group.

The CCM-270B/WS supports three group levels.

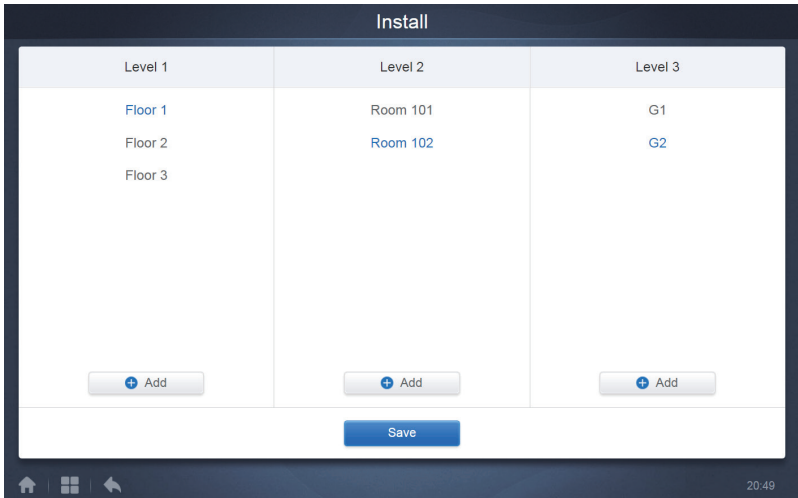

Tap the back key at lower-left corner to return to the group page.

8.2.1.1 Create Group

Tap , and you will get a text box for you to edit the group at the corresponding level, and the mouse is active.



Enter the name. Tap the CR ("Go") key on the keyboard, or tap in the blank space to exit the editor. Groups at the same level cannot have the same names. A group name may include up to 12 characters. You will receive a prompt during "Save" if the name exceeds 12 characters.

8.2.1.2 Edit, Delete Group

When a group is selected, you will see the edit and delete function keys for the selected group.



Tap the edit icon to go to the group name editor



Tap "Delete" to delete the group.

Note: Make sure you tap "Save" at the bottom of the page to save all create and edit operations. Otherwise, the changes will be discarded.

8.3 Add indoor unit to group

In the group page, you can add and delete the indoor units in the group.

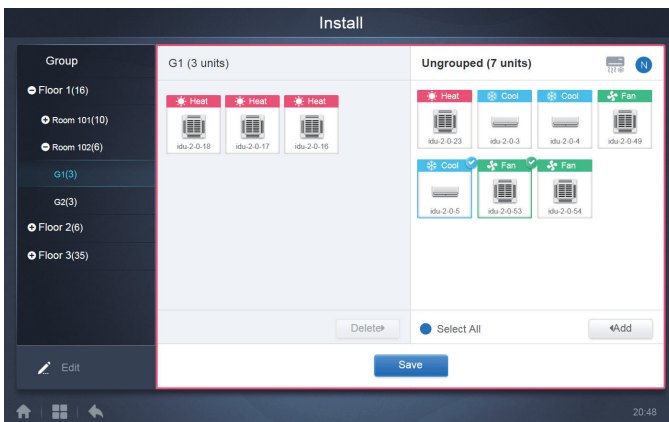

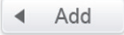
Select the indoor unit you need to operate from the group list on the left. Tap  to add the indoor unit to the corresponding group.

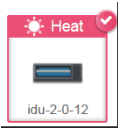

If the selected group has subgroups, they are displayed as follows:

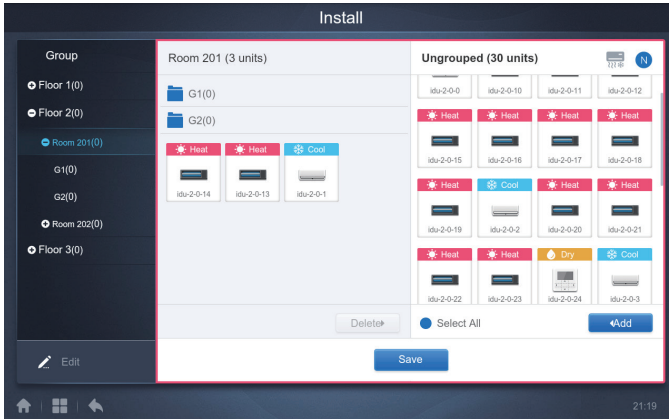

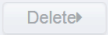
In the middle area, select the indoor unit to be deleted, tap  to remove the indoor unit from the corresponding group.

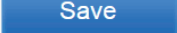
Note: Once the edits to the indoor units in the group have been completed, tap  (at the bottom of page) to save the changes. If the changes have not been saved and you directly switch to other groups, you will receive the following prompt, "Changes have not been saved. Save the changes?"

9 Settinghh

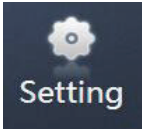

Tap on the Home Page to go to the Settings page. Default is the General module.

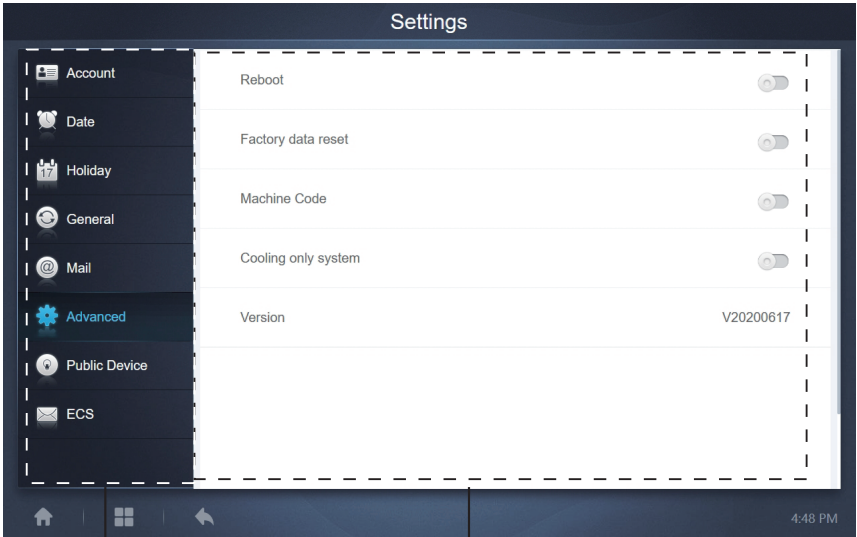

1

2

No.	Functions
1	List of available functions in the settings page. Tap to jump to the corresponding tab.
2	Shows details of the different tabs.

9.1 Account

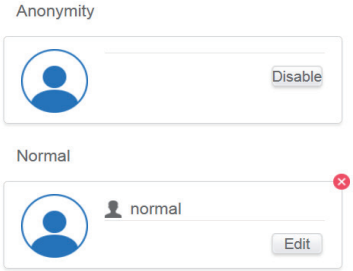

+ Add
 Normal user page

No.	Functions
1	View the status of the guest account. If the permissions have not been modified, tap to see <div style="background-color: #334d5d; color: white; padding: 20px; text-align: center;">  <p>You have no operation permission.</p> <div style="background-color: #3498db; color: white; padding: 10px 20px; display: inline-block; border-radius: 5px;">OK</div> </div>
2	Only display your own account information. You cannot delete your own account. You can only change the password. Operations to change password are similar to that for the administrator.
3	Tap when no operation permission has been set to see.

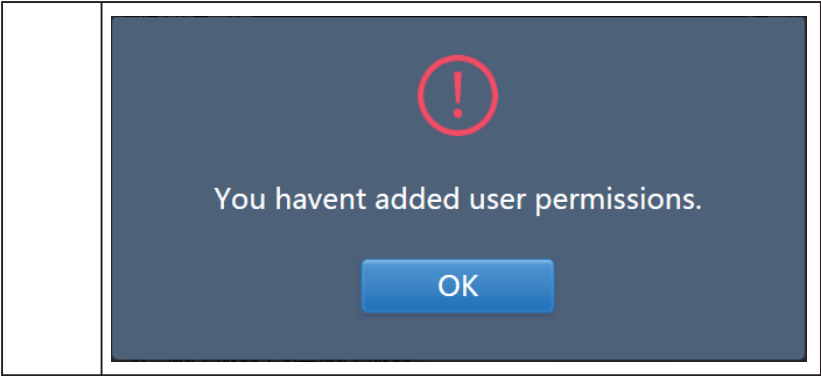

Default is maximum 15 characters for account name and password.
Default account is "normal", password "123456";

9.2 Date

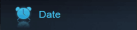
Tap the list to go to the  tab to set the date and time as shown in Figure 9.2.1. Default is the No Edit page. View the current date and time. Use "◀" and "▶" or any grey numbers that do not belong to this month to jump to another month. Tap to check the blue icon on the left of "Modify date and time" to enter the Edit mode as shown in Figure 9.2.2.

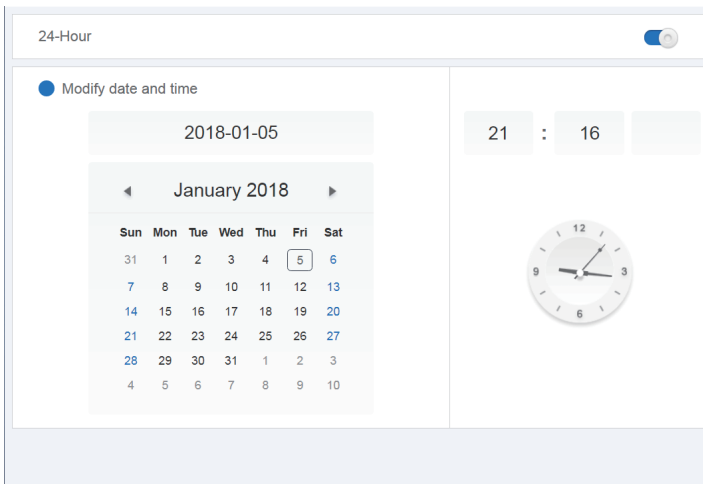

Figure 9.2.1 No Edit mode

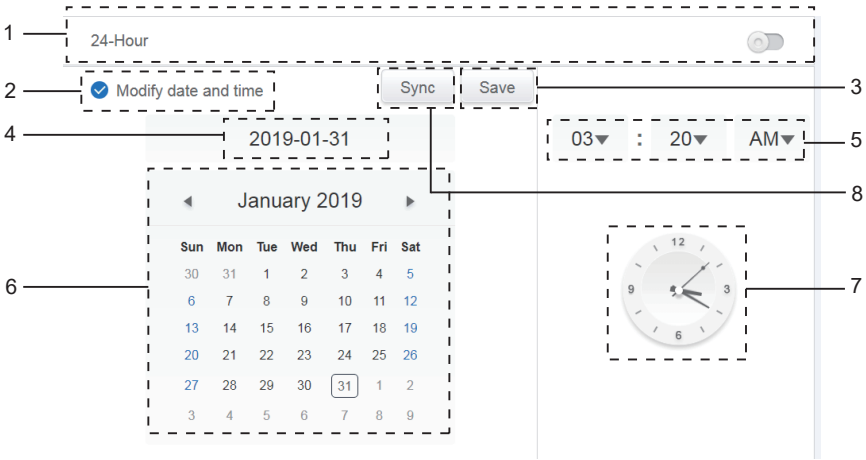
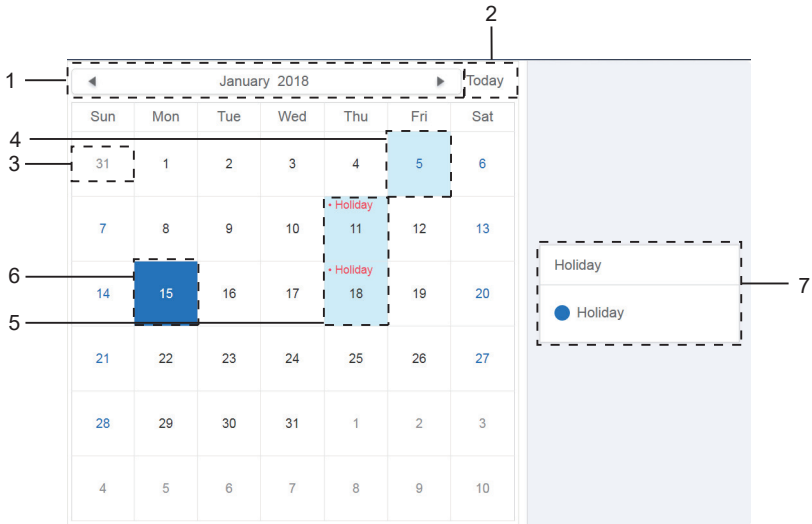



Figure 9.2.2 Edit mode

No.	Functions
1	Use to switch between 24-hour and 12-hour clock system. You can adjust the system timing system in both Edit and No Edit modes. When the slider is white and inactive, slide to the left, and the slider becomes blue and active, and the system switches to the 24-hour clock system. When the slider is active, slide to the right and the slider is now inactive, and system switches to a 12-hour clock system.
2	Tap the blue icon on the left side of "Modify date and time". Once this icon is checked, Edit mode is on. Tap again to uncheck the icon to exit the Edit mode, and all changes will be discarded.
3	Appears only when Edit is on to save the changes to the date and time. Tap to save the result and exit the Edit mode.
4	Displays the current system date when Edit is off. Displays the date selected when Edit is on.
5	Displays the current system time in the No Edit mode. Tap "▼" when Edit is on to activate the number selection list to adjust the time. Scroll the list to select the desired time, and close the list.
6	Displays dates in a calendar format with a solid box to frame today's date. Tap the grey numbers or "◀" and "▶" to change the month. When Edit is off, you can only view the calendar. When Edit is on, tap on any date to select and modify the date. Selected dates have a blue background.
7	Displays the current time in the form of a clock. Clock stops when Edit is on. Automatically skip to the modified time once the modified time is saved.
8	Sync (this function is available only on the WEB interface): Tap this button to synchronize the time with that of the connected PC (or an equivalent terminal).

Note: When TCONTCCM270A is powered off and powered on again, the time of TCONTCCM270A needs to be calibrated first.

9.3 Holiday Settings



No.	Functions
1	Displays current year and month. Tap "◀" and "▶" to change the month.
2	Shortcut to return to the current system date. Tap to activate it immediately.
3	Dates in grey do not belong to the current displayed month. Tap to jump to the date that the grey number belongs to and select the date.
4	Light blue background colour and blue font for today's date.
5	Dates with light blue background and red text are marked as holidays.
6	Selected date has a dark blue background. Tap the dates in black or blue font to select the date.
7	Non-holidays are marked with  . Holidays are marked with  . Select the corresponding date to view its status. Tap the blue icon to switch the status.

9.4 General Settings

(Adjustment to screen brightness is only for the touch screen.)

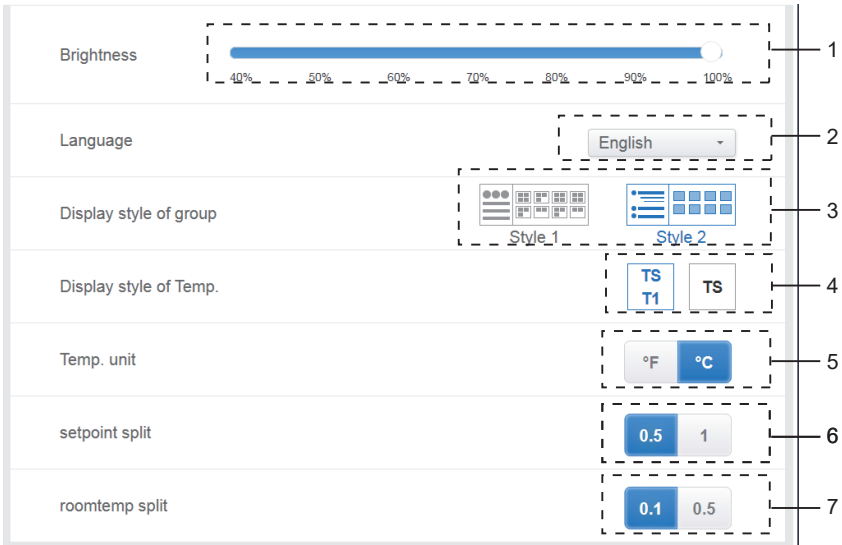

General Settings

No.	Functions
1	Adjusts the display brightness. Tap  to adjust. Slide left to reduce the brightness, and right to increase the brightness.
2	Changes the display language. Tap to activate the drop-down box, and tap to select the desired language.
3	Adjusts the group's display mode. Selected mode is highlighted in blue. Tap the grey icon to activate its mode. The two modes are mutually exclusive. The function targets the Group Navigation at the Device Monitor and Installation. Image on the right is related to the display of indoor units in the subgroups. Expand to display the indoor units in the subgroups on the right. Otherwise, the indoor units in the subgroups are merged into the subgroup folder and only the number of indoor units is displayed.
4	If the indoor ambient temperature for T1 is displayed. Left is Display, right is No Display. Selected mode is highlighted in blue. Tap the grey icon to activate its mode. The two modes are mutually exclusive.
5	Unit of temperature. Selected mode is highlighted in blue. Tap the grey icon to activate its mode. The two modes are mutually exclusive.

6	Set temperature, which is associated with option 5 Select °F. The set temperature interval can only be 1, which cannot be modified. Select °C. The set temperature interval can be 0.5 or 1, which are mutually exclusive.
7	Room temperature 0.1, 0.5. Only displayed under admin account and factory account. This option is not available for normal accounts. Related to the ambient temperature analysis, see the corresponding ambient temperature analysis instructions in detail.

9.5 Advanced Settings

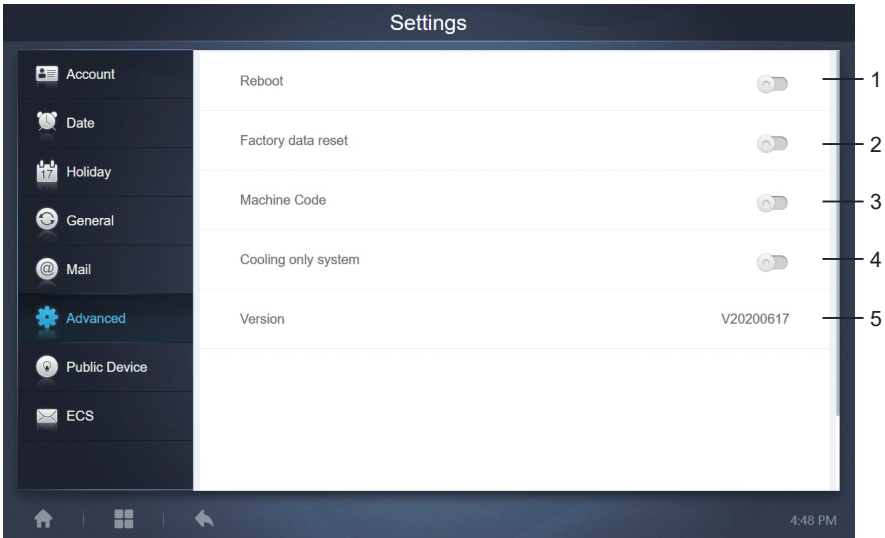

No.	Functions
1	Tap the slider to activate the dialog box. Tap "OK" to reboot the device. Tap "Cancel" to cancel all operations and exit.
2	Tap the slider to activate the dialog box. Tap "OK" to restore the device to factory settings (clear topology information, schedules, history, operating duration, running records, energy statistics, settings). Tap "Cancel" to cancel all operations and exit.
3	Indicates whether the power division function is enabled.
4	Cooling only system: If a cooling only system is connected, click the slider to activate this item.
5	Displays the current version of the software.

The power division function is activated. Tap it to display the machine code interface:

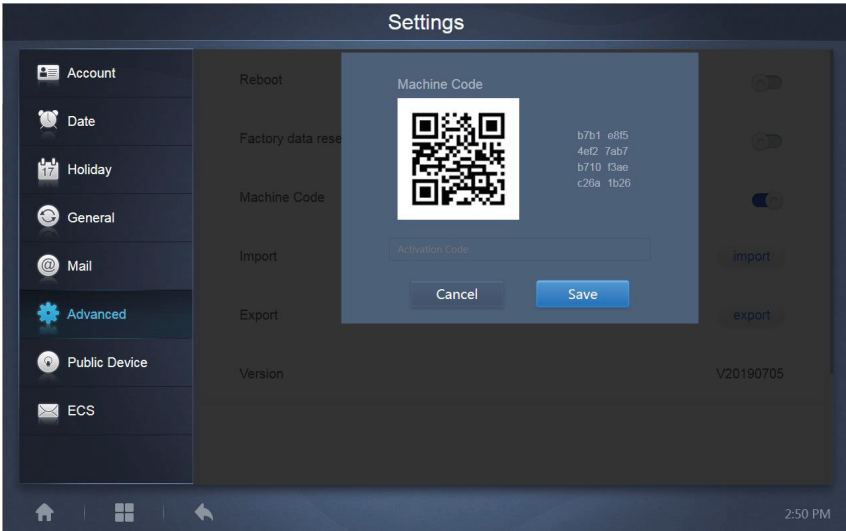

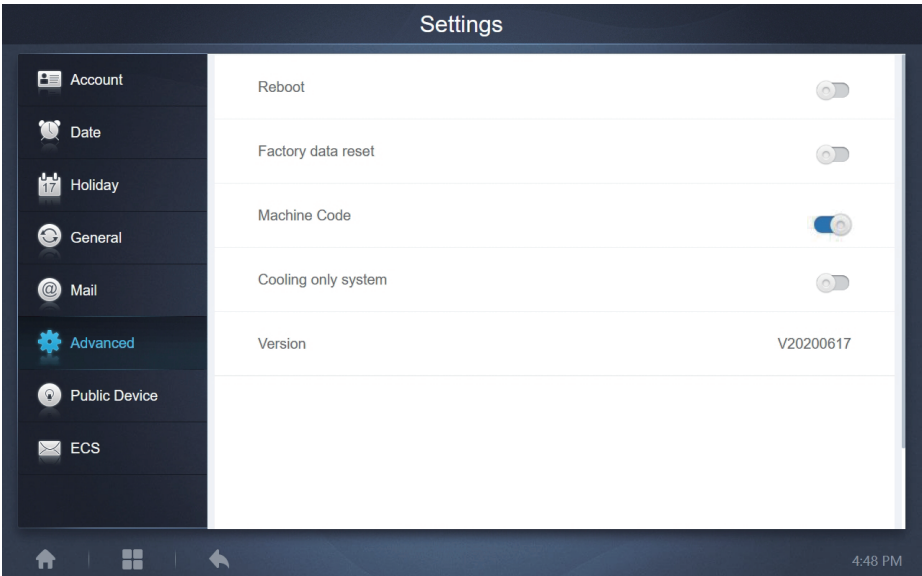

The activation status is as follows:

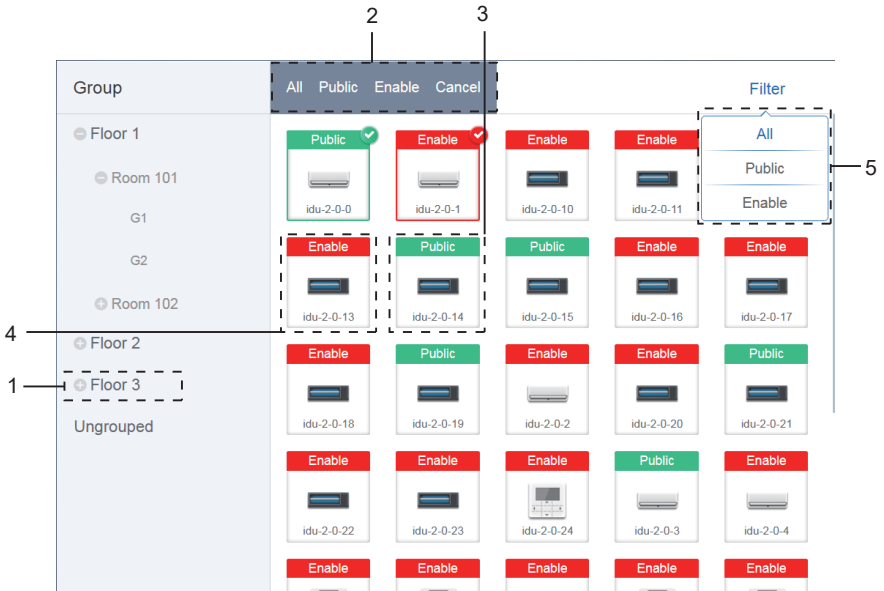

9.6 Public Device



Public Settings

No.	Functions
1	Displays the group option. All the devices in the groups (including subgroups) are displayed on the right, and the groups are arranged based on the time of creation.
2	Changes the properties of the selected devices. Public refers to public devices. Enabled refers to devices that have been enabled. Tap to select all the devices that can be selected. Tap "Cancel" to unselect all.
3	Method to display public devices.
4	Displays enabled devices. Selected device is marked by an icon at the top right corner.  indicates enabled devices that are selected.  indicates public devices that are selected.
5	Filters the devices in the group. Tap "All" to display all devices. Tap "Public" to display the public devices. Tap "Enable" to display all the enabled devices.

Note:

- For those marked as Public devices, its power will shared to all enabled devices during power allocation.
- Power from public devices is shared equally to other devices where fees are being charged. It does not distinguish the time settings. Once it is set as a public device, all queries will see that device as a public devices (power allocation is only effective during the query, the database records the original file, and the calculation is performed only during the query).
- Devices in the wired controller group do not support this function.

9.7 ECS

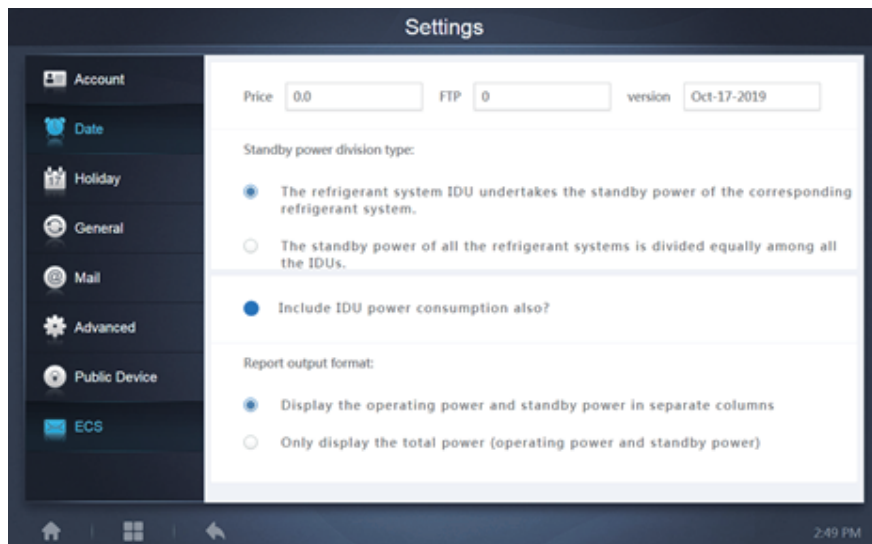

10 APPENDIX

10.1 Table of Error Codes

This manual is intended for reference only, refer to the error shown on the actual device for troubleshooting.

Please consult the factory engineer to check if the error code of the specific model belongs to a "new generation of refrigerant system".

Table of Error Codes for TVR Ultra Platform Outdoor Unit:

Error code ¹	Content
E0	Communication error between outdoor units
E1	Phase sequence error
E2	Communication error between indoor and master unit
E4	Outdoor heat exchanger temperature sensor (T3) error or outdoor ambient temperature sensor (T4) error
E5	Abnormal power supply voltage
E7	Compressor top or discharge pipe temperature sensor (T7C1/2) error
E8	Outdoor unit address error

Error code¹	Content
xE9	EEPROM mismatch
xF1	DC bus voltage error
F3	Plate heat exchanger cooling refrigerant outlet temperature sensor (T6B) error
F5	Plate heat exchanger cooling refrigerant inlet temperature sensor (T6A) error
F6	Electronic expansion valve connection error
xH0	Communication error between main control chip and inverter driver chip
H2	Number of slave units detected by master unit has decreased
H3	Number of slave units detected by master unit has increased
xH4	Inverter module protection
H5	P2 protection appears three times in 60 minutes
H6	P4 protection appears three times in 100 minutes
H7	Number of indoor units detected by master unit not same as number set on main PCB
H8	High pressure sensor error
H9	P9 protection appears ten times in 120 minutes
yHd	Slave unit malfunction
C7	PL protection appears three times in 100 minutes
P1	Discharge pipe high pressure protection
P2	Suction pipe low pressure protection
xP3	Compressor current protection
P4	Discharge temperature protection
P5	Outdoor heat exchanger temperature protection
P9	Fan module protection
PL	Inverter module temperature protection
PP	Compressor discharge insufficient superheat protection
xL0	Inverter module protection
xL1	DC bus low voltage protection

Error code¹	Content
xL2	DC bus high voltage protection
xL4	MCE error
xL5	Zero speed protection
xL7	Phase sequence error
xL8	Compressor frequency variation greater than 15Hz within one second protection
xL9	Actual compressor frequency differs from target frequency by more than 15Hz protection

Notes:

1. 'x' is a placeholder for the compressor system (compressor and related electrical components), with 1 representing compressor system A and 2 representing compressor system B. 'y' is a placeholder for the address (1 or 2) of the slave unit with the error.
2. For some error codes, a manual restart is required before the system can resume operation.
3. Once the EXV has been connected properly, the error code will flash to indicate that the connection has been re-established. A manual restart is then required before the system can resume operation.

Table of Error Codes for Indoor Units

Error code	Content
E0	Mode conflict
E1	Communication error between indoor and outdoor units
E2	Indoor ambient temperature sensor error
E3	Indoor heat exchanger mid-point temperature sensor error
E4	Indoor heat exchanger outlet temperature sensor error
E6	Fan error
E7	EEPROM mismatch
Ed	Outdoor unit error
EE	Water level error
FE	Indoor unit has not been assigned an address

Table of Error Codes for HTHM

Error code	Content
EE	EEPROM error
FE	No address error
C7	Inverter module temperature protection
E9	EEPROM mismatch
H4	Inverter module protection
H5	P2 protection appears three times in 60 minutes
H6	P4 protection appears three times in 100 minutes
1F6	Electronic expansion valve 1 connection error
2F6	Electronic expansion valve 2 connection error
E1	Communication error between hydro box and wired controller
E8	Water flow failure
F3	Water outlet temperature sensor error
F9	Water inlet temperature sensor error
F5	Tank temperature sensor error
E7	Discharge pipe temperature sensor error
FA	Suction pipe temperature sensor error
Fb	NTC temperature sensor error
FC	R410a circle liquid pipe temperature sensor error
Fd	R134a circle liquid pipe temperature sensor error
F8	Room temperature sensor error
H8	High pressure sensor error
Hb	Low pressure sensor error
E2	Communication error between hydro box and outdoor unit
H0	Communication error between main PCB and inverter driver PCB
E0	Communication error between master hydro box and slave hydro box
Ed	Outdoor unit error
E5	Abnormal power supply voltage
PP	Compressor discharge insufficient superheat protection
P1	Discharge pipe high pressure protection

Error code	Content
P2	Suction pipe low pressure protection
P3	Compressor current protection
P4	Discharge temperature protection
PL	Inverter module temperature protection
F1	DC bus voltage error
L0	Inverter module protection
L1	DC bus low voltage protection
L2	DC bus high voltage protection
L4	MCE error
L5	Zero speed protection
L7	Phase sequence error
L8	Compressor frequency variation greater than 15Hz within one second protection
L9	Actual compressor frequency differs from target frequency by more than 15Hz protection

10.2 Software Use Precautions

- a) If there are display errors on the web page such as header errors and wrong icon placements, use the browser's mandatory refresh function to refresh the page (such as "Shift+F5" for the Chrome browser).
- b) You can only enter English characters on the touch-screen. Use the Web page if you need to use other language and characters.

10.3 Wired Controller Group

For the new units, certain wired controllers support the access of multiple indoor units (IDU) where these IDUs will then form a "wired controller group". In TCONTENTSUT, these IDUs will be treated as a single virtual IDU, and in the icon view in "Device Monitor" the wired controller group of IDUs will have its own icon. The name of the wired controller group is the same as the name of the smallest IDU.

Note: Refer to the relevant manuals on wired controllers, and indoor units for specific information on how to set the address of the wires controller group.

	IDUs in wired controller group
"Device monitor" icon view	When one or more IDUs are offline in the wired controller group, the wired controller group icon will display an offline status. When there are errors in one or more IDUs in the wired controller group, the wired controller group icon will display an error status, and the error code will be the error code in the IDU with the smallest address. When the wired controller group is normal, the wired controller group icon will show the operating state of the smallest IDU.
"Device monitoring" list view	In a list view, each IDU in the group is displayed on a separate line, and you can view the details of each IDU in the group.
"Statistical data", "Energy statistics"	Each IDU in the group is displayed on a separate line, and you can view the statistics of each IDU in the group.
Send control command	The same commands are sent to the wired controllers in the group.